

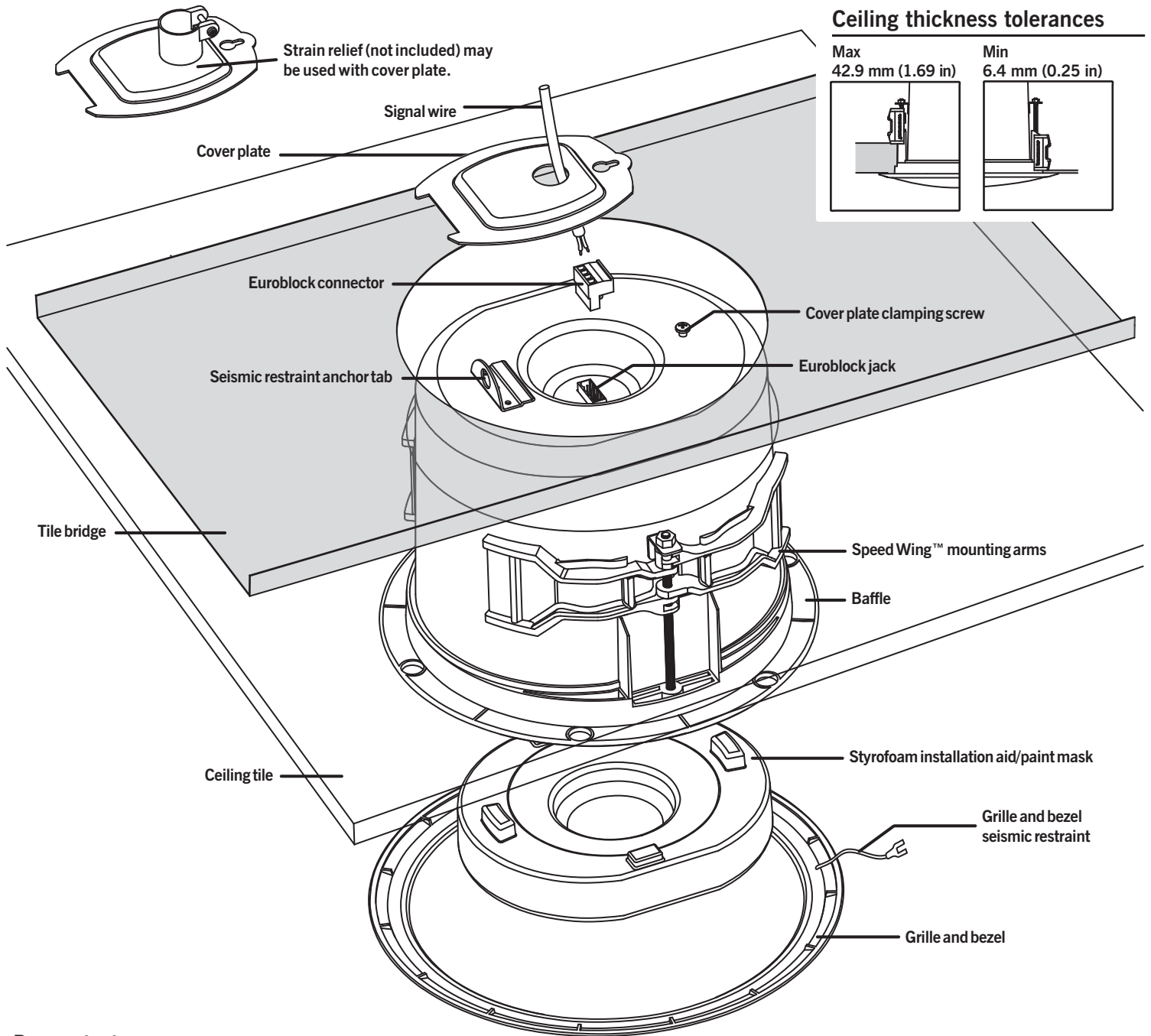

CMi Series

Install Instructions For:

CM400, CM500i, CM590i, CM600i, CM690i, CM800i, CM890i speakers



Ceiling thickness tolerances

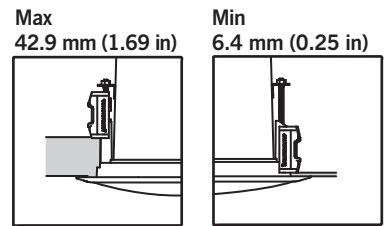

Box contents

- 1 Speaker
- 1 Euroblock connector
- 1 Grille and bezel
- 1 Styrofoam installation aid/paint mask
- 1 Cover plate
- 1 Tile bridge

1.435.647.9555 | 800.647.TUBE | www.soundtube.com

CM500i, CM600i, CM690i, CM800i, CM890i – UL listed 1480 & 2043

© 2007 SoundTube Entertainment, Inc. All rights reserved. PN INS-CMI Rev04.03.08

Warning

SoundTube speakers must be installed by a professional audio installer/contractor. For safety and for optimum audio performance, installer must follow all directions issued by SoundTube Entertainment.

Warning

Do not spec or install speaker near support beam, ventilation duct or other structure that may interfere with speaker function or dispersion.

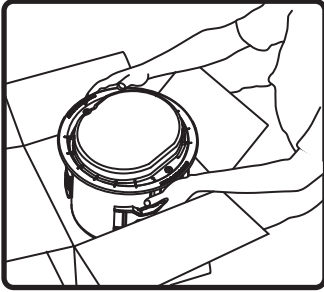

1. Unpack speaker & set aside grille assembly.

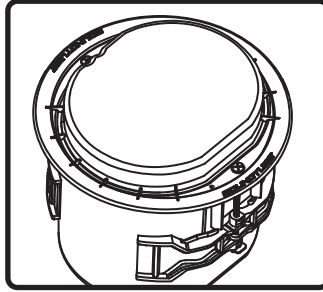

2. Keep Styrofoam installation aid/paint mask attached to speaker until speaker installation is complete.

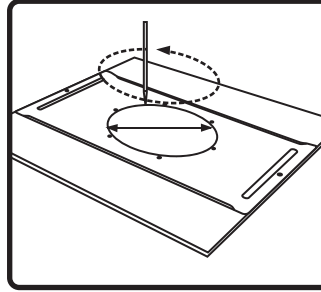

3. Use included tile bridge to mark cutout in tile.

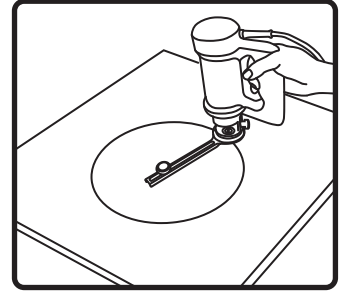

4. Use Rotozip or other tool to cut hole.

Hole Diameters
CM500i & CM590i
 228.6 mm (9.00 in)

CM600i, CM800i & CM801i
 325.1 mm (12.80 in)

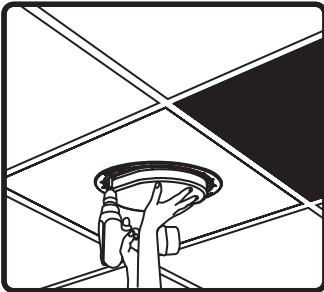

5. Insert speaker into mounting hole on ground with installation aid in place. Screw down both bolts on the baffle face to actuate the mounting wings. Firmly secure both bolts – **do not over-tighten**. Put assembly into tile grid.

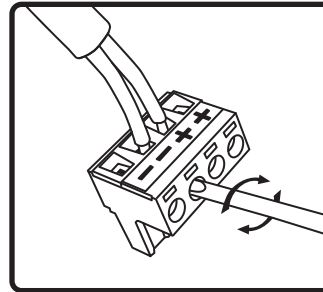

6. Thread signal wire through cover plate. Connect signal wire to 4-pin Euroblock plug. Tighten unused terminal screws. Use inside positive and negative inputs for either voice coil or distributed systems. For daisy chaining, use outside positive and negative terminals.

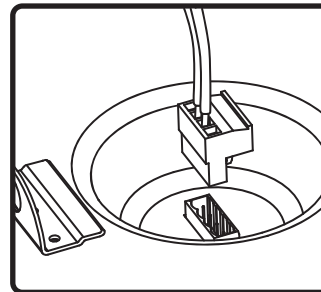

7. Insert the Euroblock plug into the Euroblock jack on rear panel of speaker and replace cover plate.
For UL-compliant installations strain relief (not supplied) may be inserted into hole in cover plate.

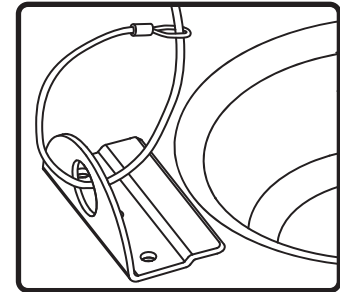

. If required, attach the seismic restraint system to the sheet-metal tab on the rear panel of the speaker (safety cable not included).

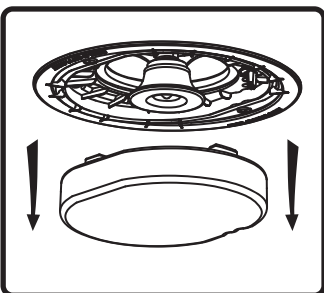

9. If you are not painting the ceiling, remove & discard the paint mask.

10. If you are painting the ceiling after the speaker is installed, leave the paint mask in place until paint is dry.

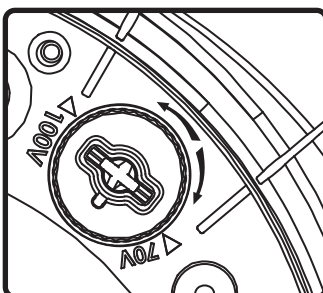

11. Select the tap position by adjusting rotary switch to desired high impedance value or voice coil bypass mode. Switch is preset to maximum tap setting in 70.7 V mode (33 W or 66 W).

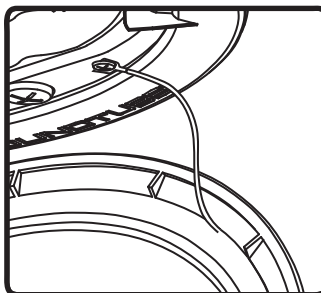

12. Attach grille & bezel seismic restraint to baffle with provided screw.

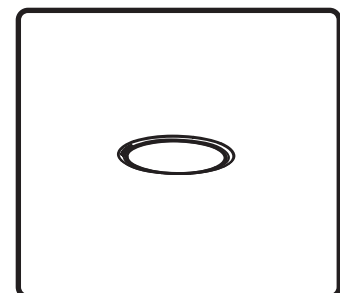

13. Attach grille – position the grille over the baffle and allow magnets to attract grille into place. Be sure grille is properly centered over baffle.

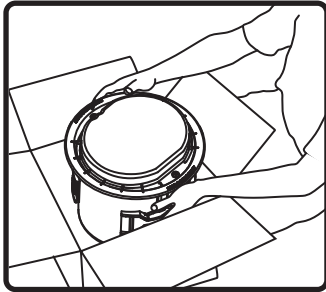

1. Unpack speaker & set aside grille assembly.

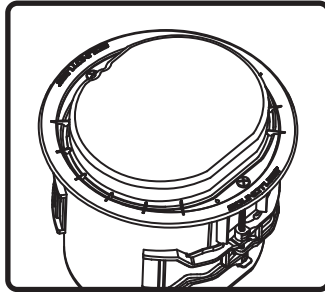

2. Keep Styrofoam installation aid/paint mask attached to speaker until speaker installation is complete.

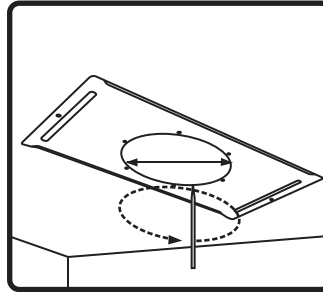

3. Use included tile bridge to mark cutout in sheetrock.

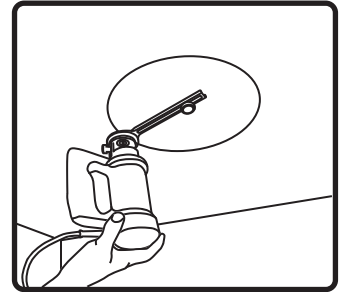

4. Use Rotozip or other tool to cut hole.

Hole Diameters
CM500i &
 228.6 mm (9.00 in)

CM600i, CM800i & CM801i
 325.1 mm (12.80 in)

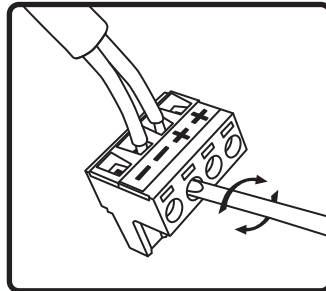

5. Thread signal wire through cover plate. Connect signal wire to 4-pin Euroblock plug. Tighten unused terminal screws. Use inside positive and negative inputs for either voice coil or distributed systems. For daisy chaining, use outside positive and negative terminals.

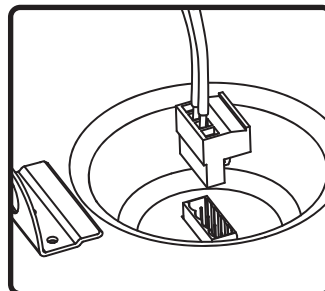

6. Insert the Euroblock plug into the Euroblock jack on rear panel of speaker and replace cover plate.
For UL-compliant installations strain relief (not supplied) may be inserted into hole in cover plate.

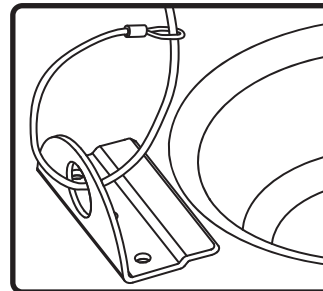

7. If required, attach the seismic restraint system to the sheet-metal tab on the rear panel of the speaker (safety cable not included).

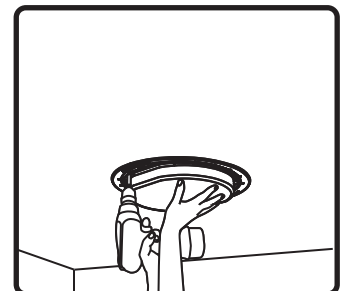

8. Insert speaker into mounting hole with installation aid in place. Screw down both bolts on the baffle face to actuate the mounting wings. Firmly secure both bolts – **do not over-tighten.**

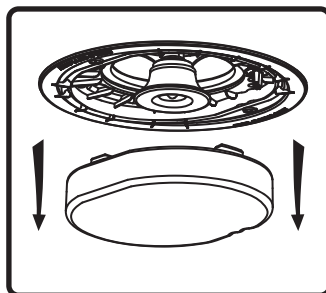

9. If you are not painting the ceiling, remove & discard the paint mask.

10. If you are painting the ceiling after the speaker is installed, leave the paint mask in place until paint is dry.

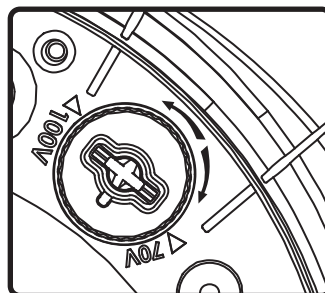

11. Select the tap position by adjusting rotary switch to desired high impedance value or voice coil bypass mode. Switch is preset to maximum tap setting in 70.7 V mode (33 W or 66 W).

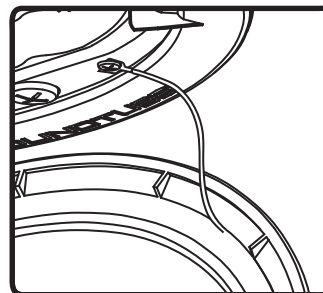

12. Attach grille & bezel seismic restraint to baffle with provided screw.

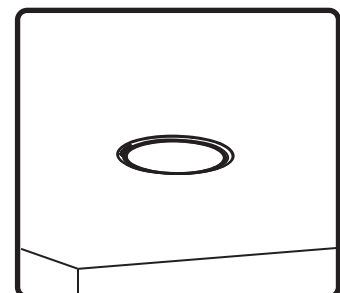

13. Attach grille – position the grille over the baffle and allow magnets to attract grille into place. Be sure grille is properly centered over baffle.

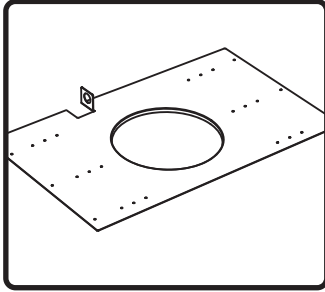

1. Nail or screw bracket to joists. Secure cover plate and conduit away from hole in bracket.

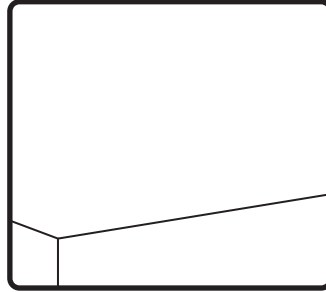

2. Complete Finish work.

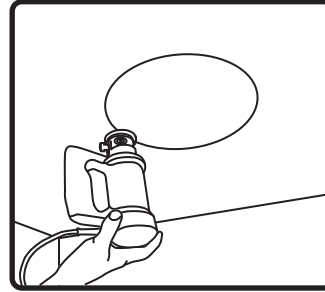

3. Use Rotozip or other tool to cut hole.

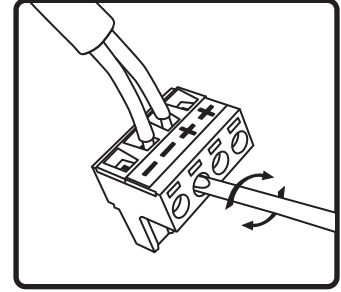

4. Thread signal wire through cover plate. Connect signal wire to 4-pin Euroblock plug. Tighten unused terminal screws. Use inside positive and negative inputs for either voice coil or distributed systems. For daisy chaining, use outside positive and negative terminals.

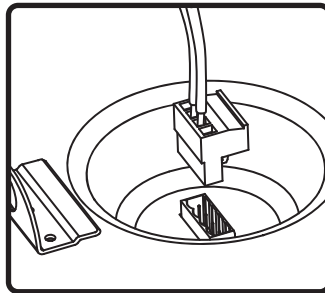

5. Insert the Euroblock plug into the Euroblock jack on rear panel of speaker and Attach cover plate and conduit.

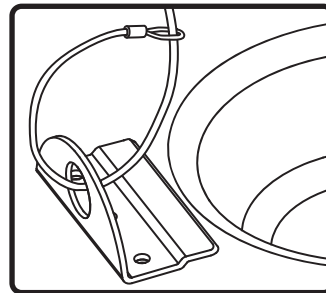

6. If required, attach the seismic restraint system to the sheet-metal tab on the rear panel of the speaker (safety cable not included).

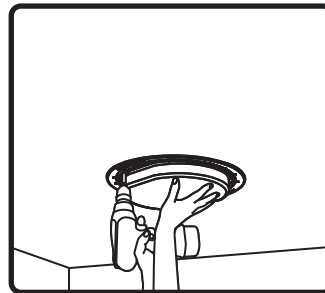

7. Insert speaker into mounting hole with installation aid in place. Screw down both bolts on the baffle face to actuate the mounting wings. Firmly secure both bolts – **do not over-tighten**.

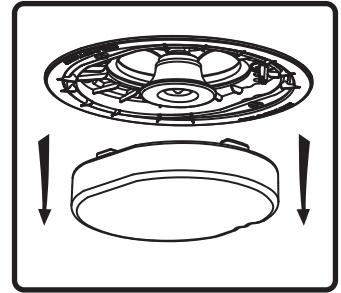

8. **If not painting** the ceiling, remove & discard the paint mask.

9. **If painting** the ceiling after the speaker is installed, leave the paint mask in place until paint is dry.

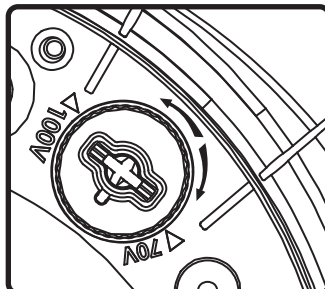

10. Select the tap position by adjusting rotary switch to desired high impedance value or voice coil bypass mode. Switch is preset to maximum tap setting in 70.7 V mode (33 W or 66 W).

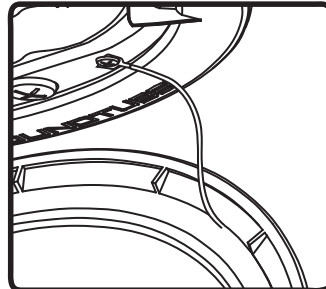

11. Attach grille & bezel seismic restraint to baffle with provided screw.

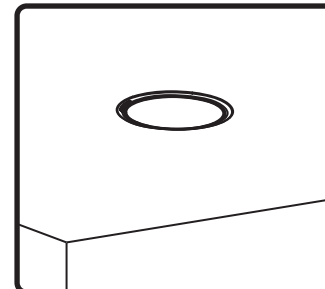

12. Attach grille – position the grille over the baffle and allow magnets to attract grille into place. Be sure grille is properly centered over baffle.