

HD Color Video Camera

Operating Instructions

Before operating the unit, please read this manual thoroughly and retain it for future reference.

SRG-120DH

Table of Contents

Overview

| | |
|--|----|
| Features | 3 |
| Camera and Supplied Accessories | 3 |
| System Configuration | 5 |
| Location and Functions of Parts and Controls | 8 |
| Camera | 8 |
| Infrared Remote Commander (supplied) | 11 |

Adjusting and Setting with Menus

| | |
|--------------------------------------|----|
| About On-Screen Menus..... | 13 |
| Main Menu | 13 |
| Setting Menus | 13 |
| Control Button Display Section | 14 |
| EXPOSURE Menu | 15 |
| WHITE BALANCE Menu | 16 |
| PICTURE Menu | 17 |
| PAN TILT ZOOM Menu | 17 |
| SYSTEM Menu | 18 |
| STATUS Menu | 19 |

Operation Using the Supplied Infrared Remote Commander

| | |
|---|----|
| Before Operating..... | 20 |
| Turning on the Power | 20 |
| Pan/Tilt and Zoom Operation | 21 |
| Panning and Tilting | 21 |
| Zooming | 22 |
| Operating Multiple Cameras with the Infrared Remote Commander | 23 |
| Adjusting the Camera | 23 |
| Focusing on a Subject | 23 |
| Shooting with Back Lighting | 24 |

| | |
|--|----|
| Storing the Camera Settings in Memory — the Presetting Feature | 24 |
|--|----|

Installation and Connection

| | |
|--|----|
| Installing the Camera..... | 26 |
| Installing the Camera on a Desk | 26 |
| Attaching the Camera to a Tripod | 26 |
| Installing the Camera Using the M3 Fixing Screw Holes | 26 |
| Connections | 27 |
| Connecting to an AC Outlet | 27 |
| Connecting a Computer | 27 |
| Connecting the RM-IP10 IP Remote Controller | 28 |
| Connecting a Video Monitor, etc., Equipped with HDMI Input Connector | 29 |

Appendix

| | |
|--------------------------|----|
| Message List..... | 30 |
| Troubleshooting..... | 31 |
| Menu Configuration | 33 |
| Preset Items | 36 |
| Specifications | 38 |
| License | 40 |

Features

- The 1/2.8 type Exmor CMOS camera (utilising approximately 2 million valid pixels) allows for high-definition shooting with superior picture quality.
- 12x optical zoom with wide-range 71-degree horizontal angle zoom lens.
- By adopting its wide and dynamic range functions, you can see the optimised shooting image which incorporates bright and dark subjects at the same time.
- Adopts the industry standard RS-232 interface of VISCA camera protocol in external communication. Long distance remote operation available using RS-232.
- High-speed and low-noise pan/tilt functions support a variety of purposes.
- You can use the infrared remote commander to set the camera and also to select panning, tilting and zooming from the setting menu.
- You can store up to 16 kinds of camera direction and camera status into the camera.
- You can use the LAN cable for external communication. This will make system construction easier.
- The camera can be set for a variety of HD video formats and has an HDMI interface terminal. The HDMI video interface is in widespread use.

Camera and Supplied Accessories

When you unpack, check that all the supplied accessories are included.

Camera (1)

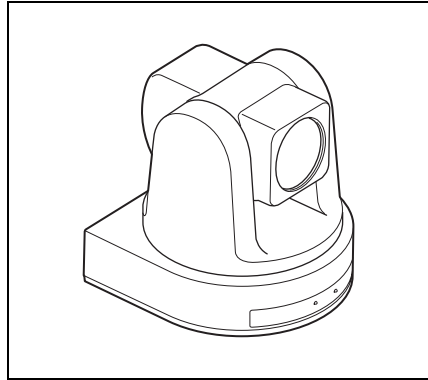

AC power adaptor (1)

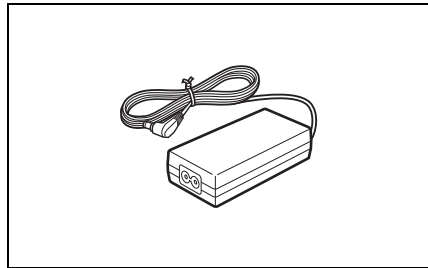

AC power cord (1)

Infrared remote commander (1)

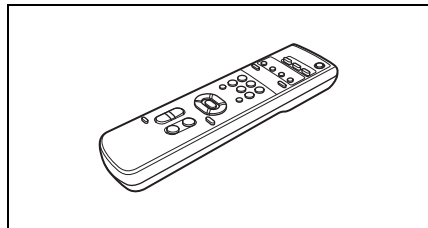

Operating Instructions (CD-ROM) (1)

Optional Products

RM-IP10 IP Remote Controller

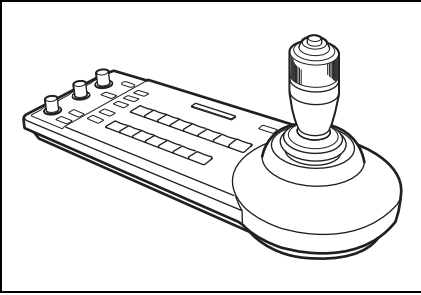

Operate up to 112 cameras that are compatible with IP connection, using LAN connection. Up to five RM-IP10 IP remote controllers can be installed to the same system.

The joystick of the IP remote controller allows you comfortable pan/tilt and zoom operations. The IP remote controller also allows operation of up to seven cameras by using the RS-232 connections.

Supplied accessories: AC adaptor (1), AC power cord (1), RS-422 connector plug (2), CD-ROM (1)

System Configuration

The SRG-120DH HD Color Video Camera has various system configuration capabilities using optional products. This section describes three typical system examples with the required components and the main usage of each system.

Operating a SRG-120DH Camera Using the Supplied Infrared Remote Commander

This system allows you:

To operate the camera readily from a short distance

System configuration

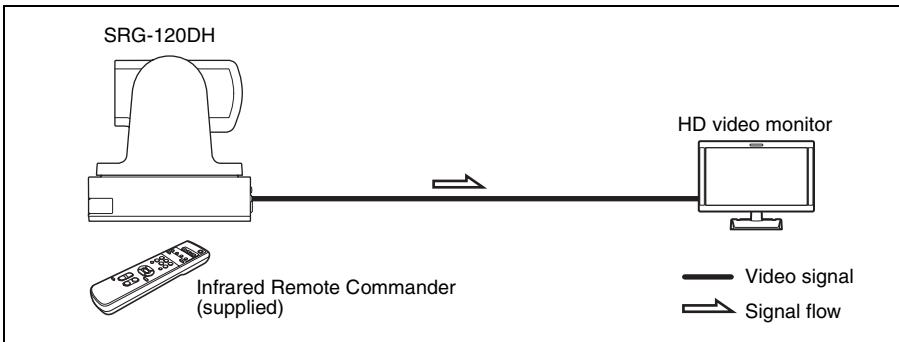

Operating a SRG-120DH Camera Using the RM-IP10 IP Remote Controller

This system allows you:

To perform pan/tilt and zoom operations using the joystick of the IP remote controller, and to perform the Preset operation using the button.

System configuration

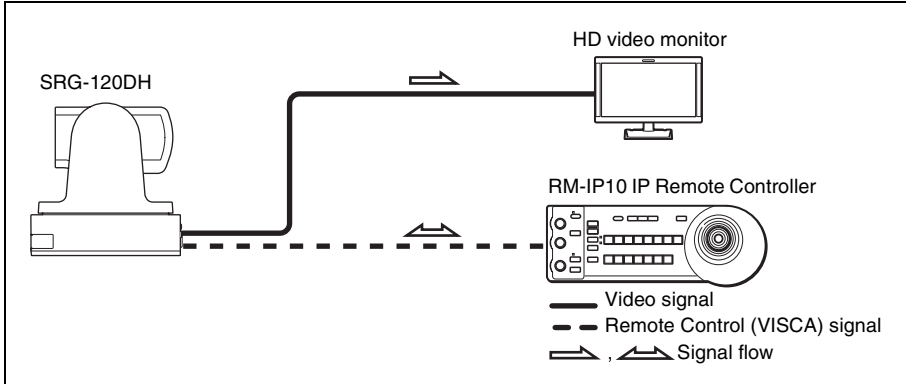

Note

Select the MODE selector of RM-IP10 to position 0 (automatically selected) when using a combination of SRG-120DH and RM-IP10. For details, refer to the Operating Instructions of RM-IP10.

Operating Multiple SRG-120DH Cameras Using Multiple IP Remote Controllers

System configuration

- You can connect up to 112 cameras and five IP remote controllers.
- The joystick of the IP remote controller allows comfortable pan/tilt and zoom operations.

System configuration

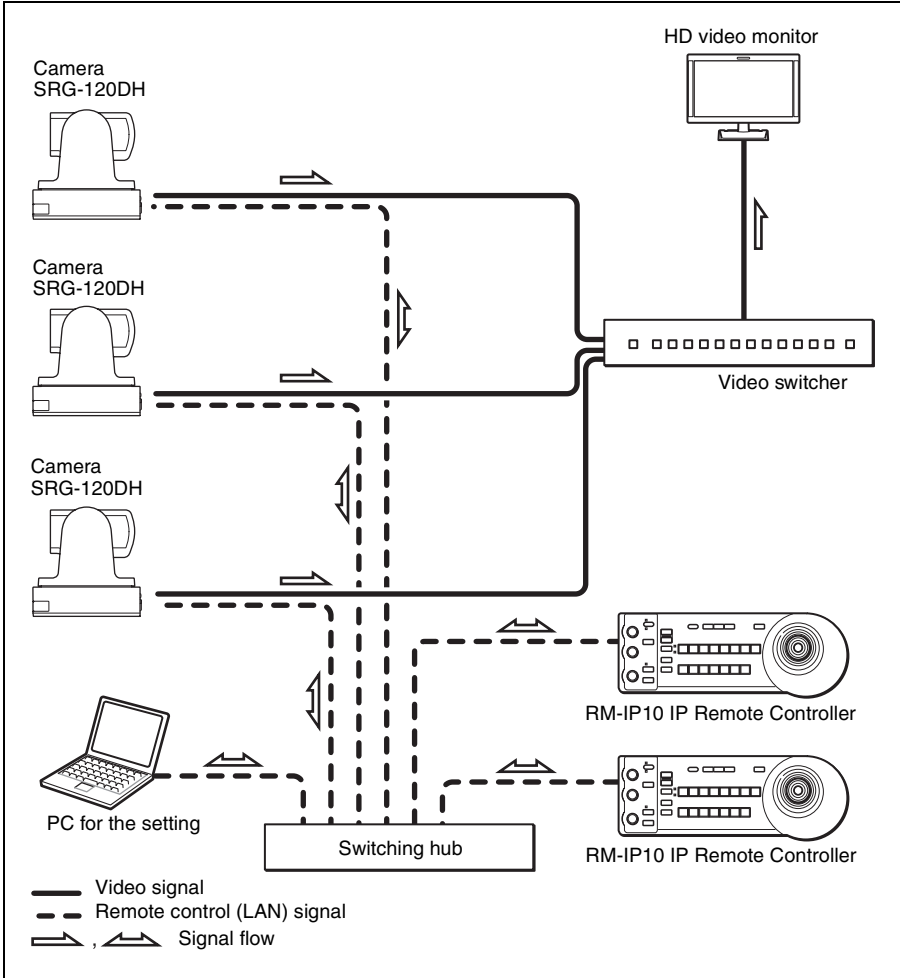

Note

You cannot use the RS-232 connections when using the LAN connection.

Location and Functions of Parts and Controls

Camera

Front

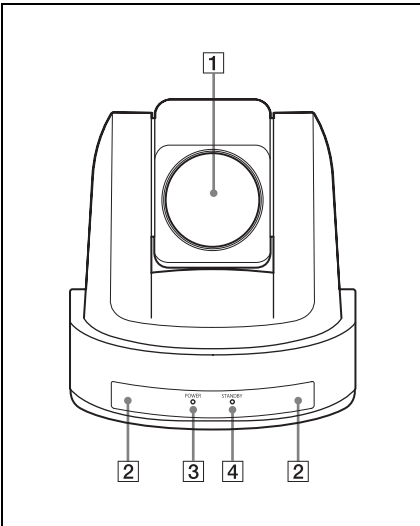

- 1 Lens**
This is a 12-magnification optical zoom lens.
- 2 Infrared remote commander sensors**
These are sensors for the supplied infrared remote commander.
- 3 POWER lamp**
The green lamp lights when the camera is connected to an AC outlet using the supplied AC power adaptor and AC power cord. It takes about 15 to 30 seconds to display the image after the lamp lights.
The green lamp flashes when the camera receives an operation command from the supplied infrared remote commander.

- 4 STANDBY lamp**
The orange lamp lights when the camera is turned off using the infrared remote commander.

Rear

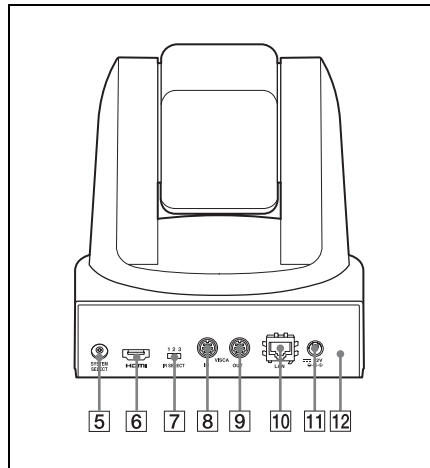

- 5 SYSTEM SELECT switch**
Used for selecting the video format of the signal to be output from the HDMI video connector.
For details, see "Setting of the SYSTEM SELECT switch" (page 9).
- 6 HDMI video connector**
Supplies the images as a HDMI video signal or DVI video signal.
- 7 IR SELECT switch**
Select the camera number when you operate multiple cameras with the same infrared remote commander.
- 8 VISCA IN connector**
Connect to a computer via an RS-232 interface. When you connect multiple cameras, connect it to the VISCA OUT connector of the previous camera in the daisy chain connection.
- 9 VISCA OUT connector**
When you connect multiple cameras, connect it to the VISCA IN connector of the next camera in the daisy chain connection.

10 LAN connector (RJ-45 8-pin)

Connect to a switching HUB that is compatible with 10BASE-T/100BASE-TX using a LAN cable (category 5 or higher, shielded twisted pair).

When a link is established, the green indicator lights, and it flashes during communication. While connected with 100BASE-TX, the yellow indicator also lights.

CAUTION

For safety, do not connect the connector for peripheral device wiring that might have excessive voltage to this port. Follow the instructions for this port.

11 DC 12 V connector

Connect the supplied AC power adaptor.

12 Reset switch

The reset switch is available only when LAN is set. If you press this switch with a pointed tip for about five seconds, the camera will reboot and the IP settings will return to the factory default.

Factory settings for IP

IP address: 192.168.0.100
 Subnet mask: 255.255.255.0
 Name: CAM1

Bottom

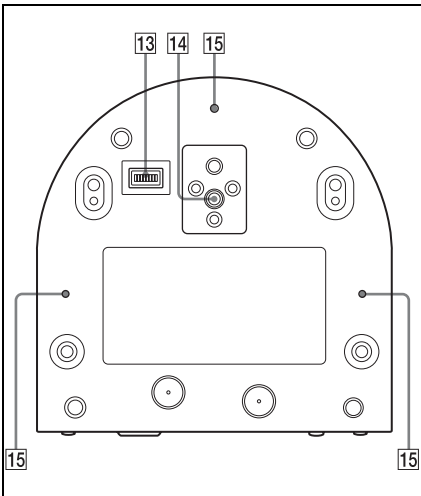

13 BOTTOM switches

Used for LAN and VISCA CONTROL switching, 9,600 bps and 38,400 bps baud rate selection and IR signal output setting.

For details, refer to the setting of the BOTTOM switches (page 10).

14 Tripod screw hole (1/4-20UNC)

When you use a tripod screw, use this screw hole to fix it.

15 Mounting screw hole (M3)

Use this hole to secure a bracket, etc.

Setting of the SYSTEM SELECT switch

This switch allows you to select the video format of the signal to be output from the HDMI video connector.

SRG-120DH

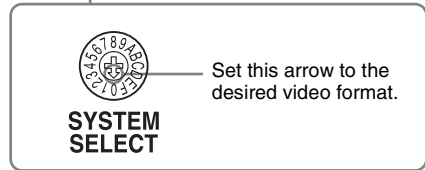
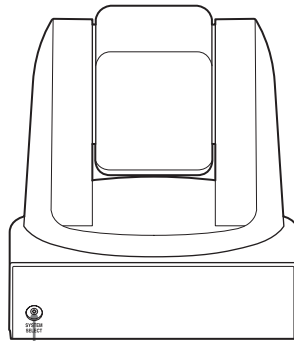

| Switch position | Video format | |
|-----------------|------------------|-----------------|
| 0 | 1920×1080p/59.94 | 59.94 Hz system |
| 1 | No output | |
| 2 | 1920×1080p/29.97 | |
| 3 | 1920×1080i/59.94 | |
| 4 | 1280×720p/59.94 | |
| 5 | 1280×720p/29.97 | |

| Switch position | Video format | |
|-----------------|---------------|--------------|
| 6 | EDID | — |
| 7 | VISCA CONTROL | — |
| 8 | 1920×1080p/50 | 50 Hz system |
| 9 | No output | |
| A | 1920×1080p/25 | |
| B | 1920×1080i/50 | |
| C | 1280×720p/50 | |
| D | 1280×720p/25 | |
| E | No output | — |
| F | No output | — |

Notes

- Be sure to set this switch before you turn on the power of the camera. You can also set this switch in the standby mode of the camera. After completing the setting, turn on the power of the camera by connecting it to an AC outlet using the supplied AC power adaptor and AC power cord, by using the VISCA command or infrared remote commander.
- Be sure to use a Phillips-head screwdriver when changing the switch position. If you use a tool other than the designated screwdriver, the crossed groove may be damaged.
- If the switch position is set to 1, 9, E or F (no output), the POWER lamp and STANDBY lamp will both remain lit. In such cases, control via the infrared remote commander and VISCA commands is disabled.
- If the switch is set to EDID, the most suitable format will be output automatically based on the resolution of the TV monitor to be connected.
- If the switch position is set to 7 (VISCA CONTROL), you can configure the video format via external communication.

For detailed information, refer to the Technical Manual of the camera. For details on obtaining a Technical Manual, consult your Sony dealer.

Setting of the BOTTOM switches

To change the setting of the BOTTOM switches, turn off the camera (unless it is in standby mode) first, set the BOTTOM switches, then turn on the camera again. Changing the BOTTOM switches is not possible while the camera is turned on.

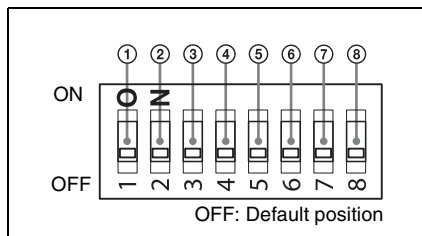

① VISCA/LAN switch

Select the control setting.
Set to ON to use the LAN connection and set to OFF to use the VISCA CONTROL (RS-232 serial control).

② Switch 2 (Not used)

Be sure to set this switch to OFF.

③ BAUD RATE SELECT switch (when using the serial connection)

Set the communication speed in the VISCA CONTROL.
ON: 38,400 bps
OFF: 9,600 bps

④ IR OUT switch

Set to ON to enable output of the receiver signals, which are transmitted from the infrared remote commander via the VISCA IN connector (page 40), or set it to OFF to disable the output.

⑤ Switch 5 (Not used)

Be sure to set this switch to OFF.

⑥ Switch 6 (Not used)

Be sure to set this switch to OFF.

⑦ Switch 7 (Not used)

Be sure to set this switch to OFF.

⑧ Switch 8 (Not used)

Be sure to set this switch to OFF.

Infrared Remote Commander (supplied)

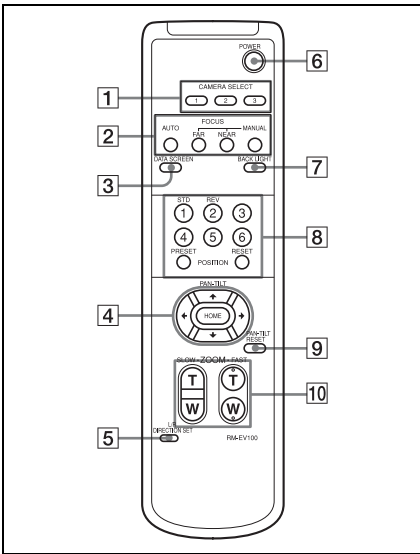

1 CAMERA SELECT buttons

Press the button corresponding to the camera you want to operate with the infrared remote commander. The camera number can be set using the IR SELECT switch on the rear of the camera.

Note

If two or more cameras are adjacent and have the same camera number, they are operated simultaneously with the same infrared remote commander. When you install the cameras close to each other, set different camera numbers.

For the camera number setting, see “Operating Multiple Cameras with the Infrared Remote Commander” (page 23).

2 FOCUS buttons

Used for focus adjustment. Press the AUTO button to adjust the focus automatically. To adjust the focus manually, press the MANUAL button, and adjust it with the FAR and NEAR buttons.

Note

Press the MANUAL button and adjust the focus manually when shooting the following objects.

- White walls and other objects without contrast
- Objects behind glass
- Objects with horizontal stripes
- Objects on which bright lights are cast or reflected
- Nightscapes and other dark objects with blinking lights
- Lit objects shot with darkened exposure adjustment or exposure compensation settings

3 DATA SCREEN button

Press this button to display the main menu. Press it again to turn off the menu. If you press the button when a lower-level menu is selected, the display goes back to a higher-level menu.

Note

Pan/tilt operations are disabled when the menu is displayed (except PAN/TILT LIMIT setting).

4 PAN-TILT buttons

Press the arrow buttons to adjust the direction of the camera. Press the HOME button to face the camera back to the front. When the menu is displayed, use \blacktriangle or \blacktriangledown to select the menu items and \blacktriangleleft or \blacktriangleright to change the set values. The selected setting menu is displayed, by pressing the HOME button when the main menu is displayed.

5 L/R DIRECTION SET button

Hold down this button and press the REV button to change the direction of the camera movement opposite to that indicated by the arrow of the $\blacktriangleleft/\blacktriangleright$ buttons. To reset the direction of the camera movement, press the STD button while holding down this button.

6 POWER button

Press this button to turn on/off the camera when the camera is connected to an AC outlet.

7 BACK LIGHT button

Press this button to enable the backlight compensation. Press it again to disable the backlight compensation.

8 POSITION buttons

Hold down the PRESET button and press button 1 to 6 to store the current camera direction, zooming, focus adjustment and backlight compensation in the memory of the pressed number button.

To erase the memory contents, hold down the RESET button and press button 1 to 6.

Note

These buttons do not function when the menu is displayed.

9 PAN-TILT RESET button

Press this button to reset the pan/tilt position.

10 ZOOM buttons

Use the SLOW button to zoom slowly, and the FAST button to zoom quickly. Press the T (telephoto) side of the button to zoom in, and the W (wide angle) side to zoom out.

CAUTION

Danger of explosion if battery is incorrectly replaced.

Replace only with the same or equivalent type recommended by the manufacturer.

When you dispose of the battery, you must obey the law in the relative area or country.

Installing batteries

Two R6 (size AA) batteries are supplied for Infrared Remote Commander.

To avoid risk of explosion, use R6 (size AA) manganese or alkaline batteries.

To install batteries

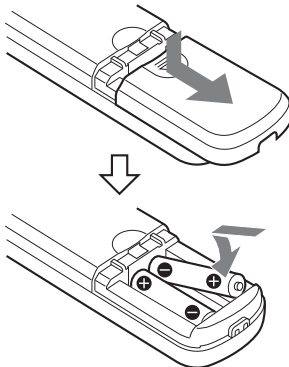

Two R6 (size AA) batteries
(not supplied)

About On-Screen Menus

You can change various settings, such as shooting conditions and system setup of the camera, while observing menu displayed on a connected monitor.

This section explains how to read the on-screen menus before starting menu operations.

For the overall menu configurations, see “Menu Configuration” (page 33).

Note

You cannot perform pan/tilt operations while the menu is displayed.

Main Menu

To display the main menu, press the DATA SCREEN button on the supplied infrared remote commander.

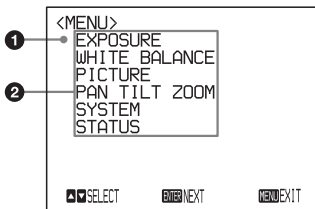

1 Selected item

Selects a setting menu. The selected item is shown by the cursor. The cursor moves up or down by pressing the \uparrow or \downarrow button on the infrared remote commander.

2 Menu items

To display a setting menu, select one using the \uparrow or \downarrow button on the infrared remote commander and press the HOME button on the infrared remote commander.

Setting Menu

The setting menu selected on the main menu is displayed.

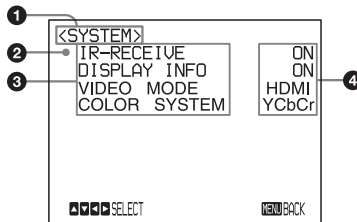

1 Setting menu

The name of the setting menu currently selected is displayed here.

2 Selected item

Selects a setting item. The selected item is shown by the cursor. Move the cursor up or down by pressing the \uparrow or \downarrow button on the infrared remote commander.

3 Setting items

The setting items for this setting menu are displayed. Select the setting item using the \uparrow or \downarrow button on the infrared remote commander.

4 Set value

The currently set values are displayed. To change a set value, use the \leftarrow or \rightarrow button on the infrared remote commander.

For the default value of each setting item, see “Menu Configuration” (page 33).

Control Button Display Section

Names of buttons displayed on the monitor are different from buttons on the infrared remote commander to be used.

Use the proper buttons on the infrared remote commander, referring to the following pictures.

Main menu

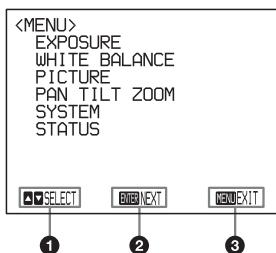

- 1 Indicates that you can select a menu item by \uparrow or \downarrow button on the infrared remote commander. The selected item is shown by the cursor.
- 2 Indicates that you can move to the next layer by pressing the HOME button.
- 3 Indicates that you can return to the normal display by pressing the DATA SCREEN button.

Setting menu

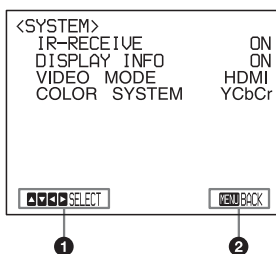

- 1 Indicates that you can select the setting item by using the \uparrow or \downarrow button and you can change the set value by using the \leftarrow or \rightarrow button.

- 2 Indicates that you can return to the main menu by pressing the DATA SCREEN button.

Note

When you are operating the menu using the supplied infrared remote commander, you cannot set IR-RECEIVE in the SYSTEM menu to OFF. To set IR-RECEIVE to OFF, use the appropriate VISCA command.

For detailed information on how to connect and VISCA command list, refer to the Technical Manual of the camera. For details on obtaining a Technical Manual, consult your Sony dealer.

EXPOSURE Menu

The EXPOSURE menu is used to set the items related to the exposure.

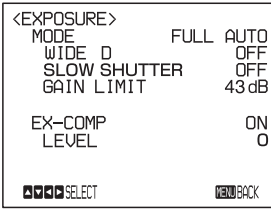

MODE (exposure mode)

FULL AUTO: The exposure is adjusted automatically using the sensitivity, electronic shutter speed, and iris.

BRIGHT: Adjust the brightness level (LEVEL) manually.

SHUTTER PRI: Shutter Priority mode.

The exposure is adjusted automatically using the sensitivity and iris. Adjust the electronic shutter speed (SPEED) manually.

IRIS PRI: Iris Priority mode. The exposure is adjusted automatically using the sensitivity and electronic shutter speed. Adjust the iris (IRIS) manually.

MANUAL: Adjust the sensitivity (GAIN), electronic shutter speed (SPEED) and iris (IRIS) manually.

When you select one from among the various exposure modes, some of the following setting items that are required for the selected mode appear.

GAIN: Select the gain from among the following:
0, 3, 6, 9, 12, 15, 18, 21, 24, 27, 30, 33, 36, 39, 43 dB

SPEED: Select the electronic shutter speed from among the following:

For the 59.94/29.97 video format:

1/1, 1/2, 1/4, 1/8, 1/15, 1/30, 1/60, 1/90, 1/100, 1/125, 1/180, 1/250, 1/350, 1/500, 1/725, 1/1000, 1/1500, 1/2000, 1/3000, 1/4000, 1/6000, 1/10000 sec.

For the 50/25 video format:

1/1, 1/2, 1/3, 1/6, 1/12, 1/25, 1/50, 1/75, 1/100, 1/120, 1/150, 1/215, 1/300, 1/425, 1/600, 1/1000, 1/1250, 1/1750, 1/2500, 1/3500, 1/6000, 1/10000 sec.

IRIS: Select the iris from among the following:

CLOSE, F14, F11, F9.6, F8.0, F6.8, F5.6, F4.8, F4.0, F3.4, F2.8, F2.4, F2.0, F1.8

LEVEL: Select the brightness level from among 0, 5 to 31.

WIDE D (Wide dynamic range mode):

When MODE (exposure mode) is set to FULL AUTO, the camera distinguishes light and dark areas in the same scene, adjusts the brightness for dark areas, and also controls the blown out highlights. You can select the wide dynamic range mode from among OFF, LOW, MID and HIGH.

Notes

- You can set the wide dynamic range mode when WIDE D is set to FULL AUTO only.
- When WIDE D is not set to OFF, the MODE setting is fixed at FULL AUTO.
- When changing WIDE D, a change in screen luminance occurs for a moment.
- When the change of exposure is big, the screen may stop for a moment.

GAIN LIMIT: Select the upper limit of the gain rise in FULL AUTO, SHUTTER PRI and IRIS PRI modes. Select from among 9, 12, 15, 18, 21, 24, 27, 30, 33, 36, 39, 43 dB.

EX-COMP (exposure compensation)

When MODE is set to one of FULL AUTO, SHUTTER PRI or IRIS PRI, set this item to ON to enable exposure compensation.

When you set EX-COMP to ON, LEVEL appears and you can select the exposure compensation level from among the following:

-7, -6, -5, -4, -3, -2, -1, 0, +1, +2, +3, +4, +5, +6, +7

If you set the level to 0, exposure compensation will be disabled. Level +7 is the brightest and -7 is the darkest compensation value.

When EX-COMP is set to OFF, exposure compensation does not function.

SLOW SHUTTER

When you set the mode to ON, the camera automatically uses slow shutter speed for exposure as the illumination of the object to be shot decreases. This mode is only available when AE mode is set to FULL AUTO.

WHITE BALANCE Menu

The WHITE BALANCE menu is used to select the white balance mode.

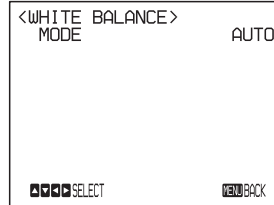

MODE (white balance mode)

Select the white balance mode from among the following:

AUTO, IN DOOR, OUT DOOR, ONE PUSH, ATW (Auto Tracing White Balance), MANUAL

When you select MANUAL, R.GAIN (red gain) and B. GAIN (blue gain) appear. You can select each item in the range from -128 to 127.

When you select the ONE PUSH mode

Perform the following operation.

- 1** Zoom in on a white subject in the center of the screen.
- 2** Press the HOME button of the supplied infrared remote commander. The one-push white balance adjustment is activated.

When DISPLAY INFO (page 18) is set to ON on the SYSTEM menu, the result of the white balance adjustment is displayed on the monitor.

PICTURE Menu

The PICTURE menu is used to set the items related to the picture.

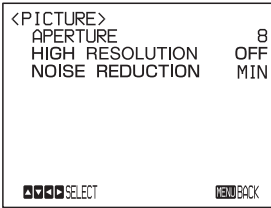

APERTURE (aperture compensation)

Select the aperture compensation level from among MIN, 1 to 14 and MAX.

HIGH RESOLUTION

You can set this mode to ON or OFF. When set to ON, you can enjoy emphasised edge and high-resolution images.

NOISE REDUCTION

You can enjoy clearer images by removing unnecessary noise (fixed pattern and randomised noise). You can select 6 levels from OFF (MIN), 1 to 5 (MAX).

PAN TILT ZOOM Menu

The PAN TILT ZOOM menu is used to select the pan/tilt/zoom mode.

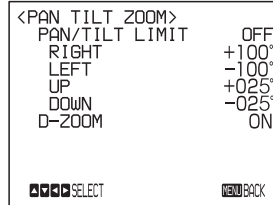

PAN/TILT LIMIT

When you set PAN/TILT LIMIT to ON, you can select the limit of pan/tilt operation.

You can select the following values:

RIGHT: +100° to -99°, selectable in 1° steps.

LEFT: +99° to -100°, selectable in 1° steps.

UP: +25° to -24°, selectable in 1° steps.

DOWN: +24° to -25°, selectable in 1° steps.

Note

The indicated value is changed when the ◀ or ▶ button is released. When the pan/tilt function is in motion, the indicated value does not change.

Setting the range of LEFT/RIGHT movement

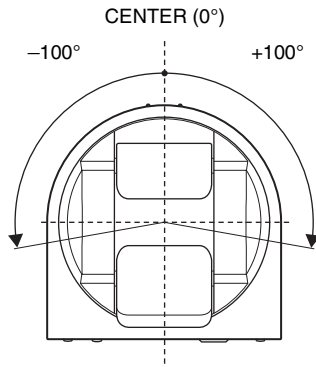

Note

The limit of pan/tilt operation becomes effective promptly after you set the range of PAN/TILT LIMIT. When you want to make the camera start with the ranges set, before turning off the power, store those values in POSITION 1.

For details, see “Storing the Camera Settings in Memory — the Presetting Feature” (page 24).

Setting the range of UP/DOWN movement

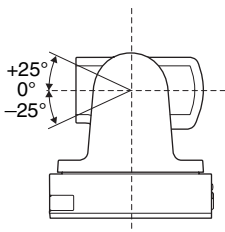

Note

When you turn the camera to the right or left beyond the 90° with the camera pointed downward by 25°, the camera may be caught on the lens, depending on the zoom position of the lens.

D-ZOOM (digital zoom)

You can set digital zoom to ON or OFF. When set to OFF, digital zoom does not operate, and only optical zoom is available. When set to ON, digital zoom takes over after optical zoom reaches MAX (12×). Up to 144× can be zoomed digitally. When digital zoom is available, the resolution decreases.

SYSTEM Menu

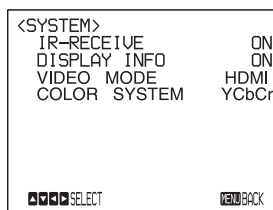

IR-RECEIVE (infrared signal reception)

When this is set to OFF, the camera does not receive the signal from the supplied infrared remote commander.

Be sure to keep it set to ON when you use the supplied infrared remote commander.

Note

You cannot set IR-RECEIVE to OFF when you operate the menu using the supplied infrared remote commander. To set it to OFF, use the appropriate VISCA command.

DISPLAY INFO

When this item is set to ON, the message automatically appears for about 3 seconds on the monitor screen, when you perform the following operations using the supplied infrared remote commander.

| Message | Remote control operation |
|--|--|
| PRESET n: OK “n” is a preset position number of the infrared remote commander, between 1 and 6. | You have stored the camera settings to POSITION 1 to 6. |
| RECALL n: OK “n” is a preset position number of the infrared remote commander, between 1 and 6. | You have read the camera settings stored in POSITION 1 to 6. |

| Message | Remote control operation |
|---|--|
| RESET n: OK “n” is a preset position number of the infrared remote commander, between 1 and 6. | You have reset the camera settings stored in POSITION 1 to 6 to the default settings. |
| ONE PUSH WB: OP | During the white balance adjustment in the ONE PUSH white balance mode, the message blinks on the screen. |
| ONE PUSH WB: OK | When white balance adjustment is correctly performed in ONE PUSH white balance mode, this message appears on the screen. |
| ONE PUSH WB: NG | If white balance adjustment is incorrectly performed in ONE PUSH white balance mode, this message flashes on the screen. |

Note

The operations in the VISCA CONTROL and LAN connection are from n: 1 to 16.

VIDEO MODE

The setting of the HDMI and DVI are available when the video is output from the HDMI video connector.

When the SYSTEM SELECT is set to EDID, the video mode cannot be set.



COLOR SYSTEM

The setting of the YCbCr and RGB are available for color space of the video image.

When the SYSTEM SELECT is set to EDID, the color system cannot be set.

STATUS Menu

The STATUS menu is used to display the settings selected with the menus.

| | |
|--|--|
| <STATUS> | PAGE1 |
| EXPOSURE | FULL AUTO |
| WIDE D | OFF |
| SLOW SHUTTER | OFF |
| GAIN LIMIT | 43 dB |
| EX-COMP | OFF 0 |
|  PAGE |  BACK |

The STATUS menu consists of PAGE1 to PAGE5.

This menu only displays the current menu settings, and you cannot change them with this menu.

PAGE1: Shows the settings selected with the EXPOSURE menu.

PAGE2: Shows the settings selected with the PICTURE menu and the WHITE BALANCE menu.

PAGE3: Shows the settings selected with the PAN TILT ZOOM menu.

PAGE4: Shows the settings selected with the SYSTEM menu, supplied infrared remote commander channel, VISCA communication baud rate, VIDEO mode, Color system and Video latency setting.

PAGE5: Shows the settings selected with the LAN connection with IP address, Subnet mask and MAC address (shows when the BOTTOM switch is set to LAN only).

Note

The VISCA communication baud rate and the VIDEO mode for the camera are displayed. Even if you change the settings after turning on the power, those settings are ignored and are not changed on the display.

For detailed information on the Video latency setting, refer to the Technical Manual of the camera.

Before Operating

Before operating the camera, check that the camera and peripheral devices are properly installed and connected.

For details, see “Setting of the SYSTEM SELECT switch” (page 9), “Installing the Camera” (page 26) and “Connections” (page 27).

Note

The supplied infrared remote commander may not work correctly near the inverter lighting fixtures. In such a case, try to install the camera far from the inverted luminaire. You can check whether or not the installed location is good for the usage of the infrared remote commander.

For detailed information on how to check, refer to the Technical Manual. For details on obtaining a Technical Manual, consult your Sony dealer.

Turning on the Power

SRG-120DH

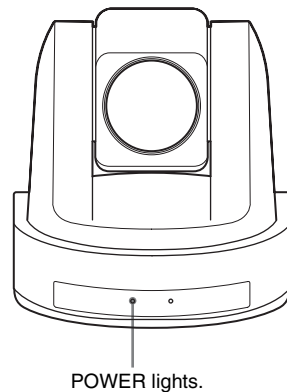
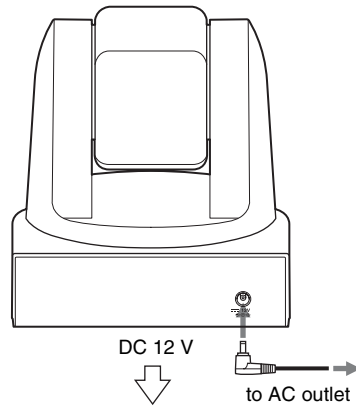

- 1** Connect the camera to an AC outlet using the supplied AC power adaptor and power cord.
The power is turned on and the POWER lamp lights.
The camera will automatically pan and tilt and be reset to the position stored in POSITION 1 (Pan/tilt reset action).
- 2** Turn on the peripheral devices.

To turn on/off the camera using the infrared remote commander

As long as the camera is connected to an AC outlet, you can turn the camera on or off with the POWER switch on the infrared remote commander.

When you turn the power off using the infrared remote commander, the POWER lamp turns off and the STANDBY lamp lights on the camera.

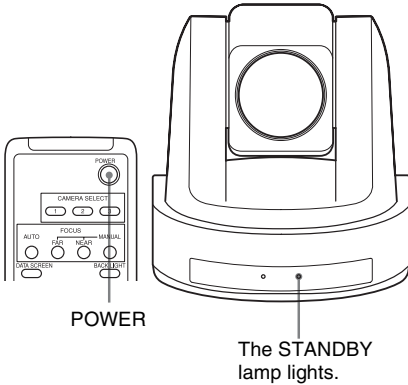

Pan/Tilt and Zoom Operation

Panning and Tilting

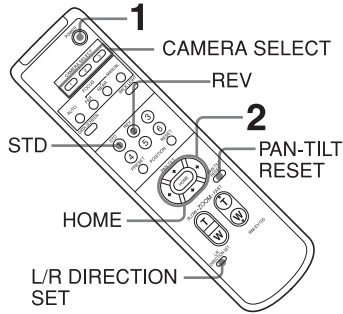

- 1** Press the POWER switch.
The camera will turn on and perform the pan/tilt reset operation automatically.
- 2** Press the arrow button to pan or tilt the camera.
While checking the picture on the screen, press the desired arrow button.
To move the camera little by little, press the button just for a moment.
To move the camera in a wide range, press and hold the button.
To move the camera diagonally, press the ◀ or ▶ button while holding down the ▲ or ▼ button.

To face the camera back to the front
Press the HOME button.

If the camera moves in a different direction from the one you intended

The camera is preset so that the image output from the camera is rotated toward the right whenever you press the ▶ button.

To face the camera toward the opposite direction

You might wish to face the camera toward the opposite direction from that of the button you pressed, for example, when you change the direction of the camera while checking the picture on the screen. In such a case, press the 2 (REV) button while holding down the L/R DIRECTION SET button.

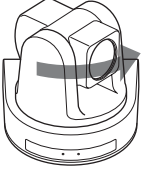
| Arrow button | Movement of the camera | Setting |
|---|---|---|
|  |  | <p>L/R DIRECTION SET While holding down</p> <p>REV 2 Press</p> |

To reset the setting

To reset the setting, press the 1 (STD) button while holding down the L/R DIRECTION SET button.

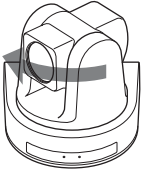
| Arrow button | Movement of the camera | Setting |
|--|--|---|
|  |  | <p>L/R DIRECTION SET While holding down</p> <p>STD 1 Press</p> |

Note

The setting above only changes the signal emitted from the infrared remote commander, and does not change the setting of the camera itself. Therefore, repeat the setting for each infrared remote commander if you are using more than one infrared remote commander.

When the STANDBY lamp is blinking

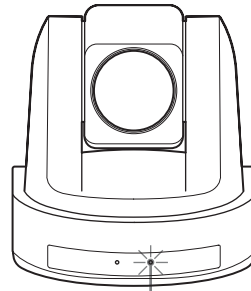

The STANDBY lamp blinks.

If the camera is moved forcibly, or a finger or other object interferes with camera movement, the camera may fail to memorize the pan/tilt position. Press the PAN-TILT RESET button to reset the pan/tilt position.

Zooming

Press either of the ZOOM buttons.

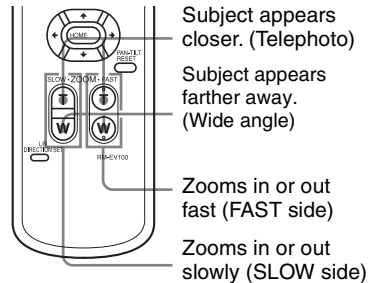

Note

When you perform pan/tilt operation while the camera is in the telephoto mode, the moving speed of the image on the screen may be a little jerky.

Operating Multiple Cameras with the Infrared Remote Commander

- 1 Set the IR SELECT switch on the rear of the camera you want to operate to 1, 2 or 3.



- 2 Press the CAMERA SELECT button on the infrared remote commander that corresponds to the number set in step 1.

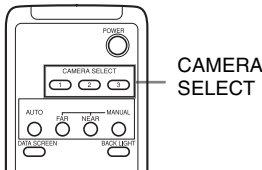

Then, you can operate the camera(s) specified by number. Every time you operate the camera(s) using the infrared remote commander, the CAMERA SELECT button pressed in step 2 lights.

Adjusting the Camera

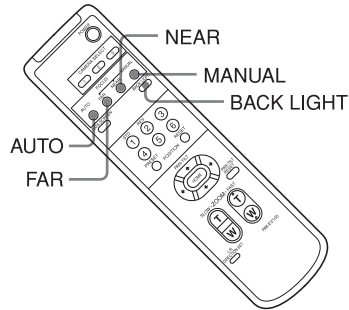

Focusing on a Subject

Focusing the camera on a subject automatically

Press the AUTO button.
The camera focuses on the subject at the center of the screen automatically.

Focusing the camera on a subject manually

After pressing the MANUAL button, press either the FAR or the NEAR button to have the camera focus on the subject.

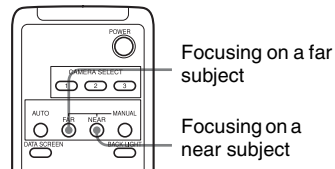

Shooting with Back Lighting

When you shoot a subject with a light source behind it, the subject becomes dark. In such a case, press the BACK LIGHT button. To cancel the function, press the BACK LIGHT button again.

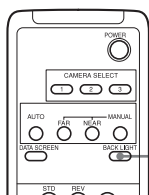

Subject appears brighter.

Note

The BACK LIGHT function is effective if MODE is set to FULL AUTO in the EXPOSURE menu of the camera.

Storing the Camera Settings in Memory — the Presetting Feature

Up to 16 combinations of settings (16 positions) including camera position, zooming, focusing, and backlighting, can be preset.

For details of the camera settings to be preset, see “Preset Items” (page 36).

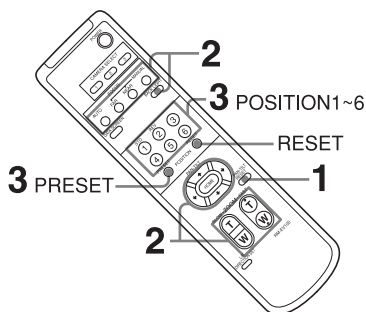

- 1** Press the PAN-TILT RESET button to reset the pan/tilt position.
- 2** Adjust the position, zooming, focusing and backlighting of the camera (page 21 to page 24).
- 3** While holding down the PRESET button, press any of the POSITION buttons, 1 to 6, in which you want to store the settings.

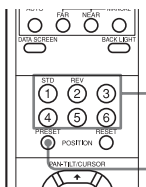

Press a POSITION button.

While holding down this button

When you set DISPLAY INFO (page 18) to ON on the SYSTEM menu, the message “PRESET n : OK” automatically appears for about 3 seconds on the monitor screen.

Recalling the stored settings

Press any of the POSITION buttons, 1 to 6, in which you have stored the settings. The message “RECALL n:OK” automatically appears for about 3 seconds on the monitor screen.

Cancelling the preset memory

While holding down the RESET button, press the POSITION button from which you want to cancel the settings.

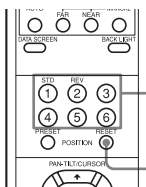

Press a POSITION button.

While holding down this button

When you set DISPLAY INFO (page 18) to ON on the SYSTEM menu, the message “RESET n : OK” automatically appears for about 3 seconds on the monitor screen.

Notes

- When the power is turned on, the camera starts with the settings stored in POSITION 1.
- If you want to retain the previous pan and tilt positions, etc. before the power is turned off and turned on again, store those positions in POSITION 1.
- When you are storing or cancelling the settings in one POSITION, you cannot call

up, store or cancel the settings in another POSITION.

- When the menu is displayed on the screen, you cannot perform the operation for storing, recalling, or cancelling the setting. Be sure to return to the normal display before starting these operations.

Installing the Camera

Installing the Camera on a Desk

Place the camera on a flat surface. If you have to place the camera on an inclined surface, make sure that the inclination is less than ± 15 degrees to guarantee pan/tilt performance, and take measures to prevent it from falling.

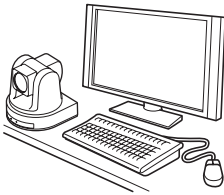

Notes

- Do not grasp the camera head when carrying the camera.
- Do not turn the camera head by hand. Doing so may result in a camera malfunction.

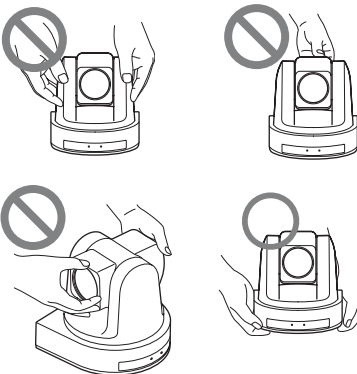

Attaching the Camera to a Tripod

Attach a tripod to the screw hole used for attaching a tripod on the bottom of the camera. The tripod must be set up on a flat surface and its screws tightened firmly by hand. Use a tripod with screws of the following specifications.



$l = 4.5$ to 7 mm
 $l = 0.18$ to 0.27 inches

Caution

Installation of the camera using the tripod screws and screw holes should not be done for installation on a ceiling or a shelf, etc., in a high position.

Installing the Camera Using the M3 Fixing Screw Holes

Attach the camera using 3 M3 fixing screw holes located on the bottom of the camera. Attach the camera to a fitting with a flat surface using M3 screws with the following specifications.

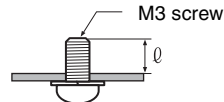

$l = 3$ to 8 mm
 $l = 1/8$ to $11/32$ inches

Connections

Connecting to an AC Outlet

Use the supplied AC power adaptor and AC power cord to connect the camera to an AC outlet.

SRG-120DH

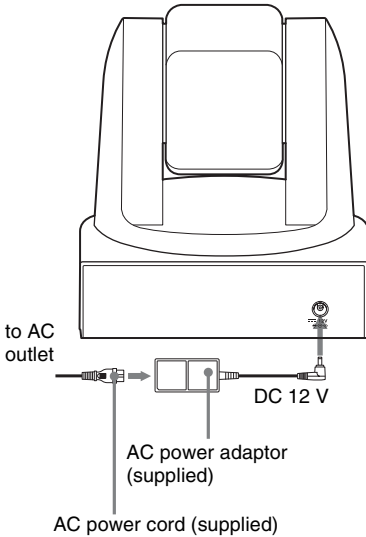

Connecting a Computer

RS-232 Connections

SRG-120DH

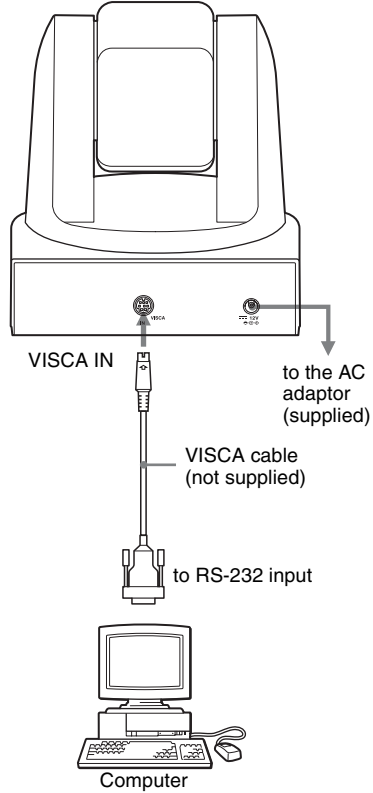

Notes

- When you connect a computer to the camera using the VISCA cable (RS-232 cross cable), you can control the camera from a computer instead of the supplied infrared remote commander.
- In the case of VISCA RS-232 connection, make sure that the BOTTOM switch is set to VISCA (RS-232 serial control) (page 10).
- The VISCA cable cannot be used in the case of a LAN connection.

To obtain a cable, consult your Sony dealer. For detailed information on how to connect the camera and the VISCA command list, refer to the Technical Manual of the camera. For details on obtaining a Technical Manual, consult your Sony dealer.

LAN connection

SRG-120DH

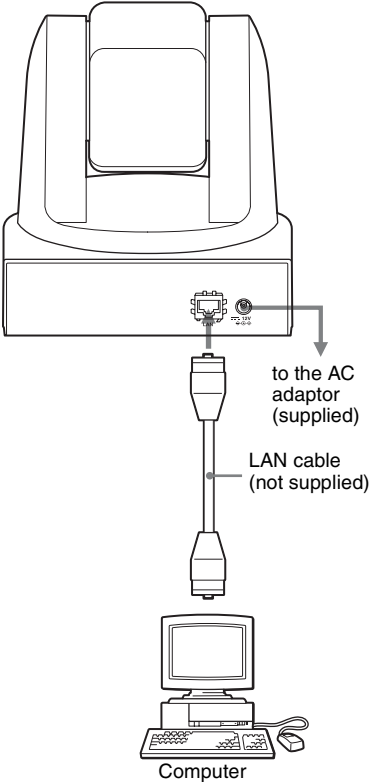

Notes

- In the case of a LAN connection, make sure that the BOTTOM switch of the camera is set for LAN connection (page 10).
- Dedicated application software is needed. For details about the application software, consult your Sony dealer.

- Use a LAN cable that is compatible with 10BASE-T/100BASE-TX (category 5 or higher, shielded twisted pair) for this connection.

Connecting the RM-IP10 IP Remote Controller

RS-232 Connections

Use the RS-232 connecting cable supplied with the IP remote controller.

SRG-120DH

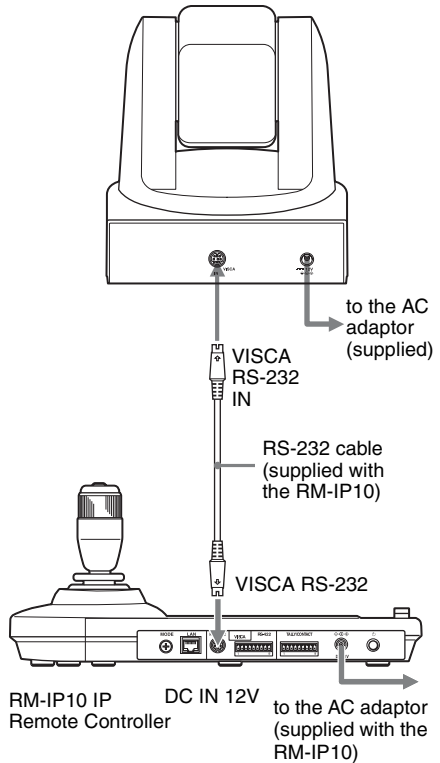

Note

When using the VISCA RS-232 connectors, check that the BOTTOM switch on the bottom of the camera (page 10) and the BOTTOM switch on the bottom of the IP remote controller are set to RS-232.

LAN connection

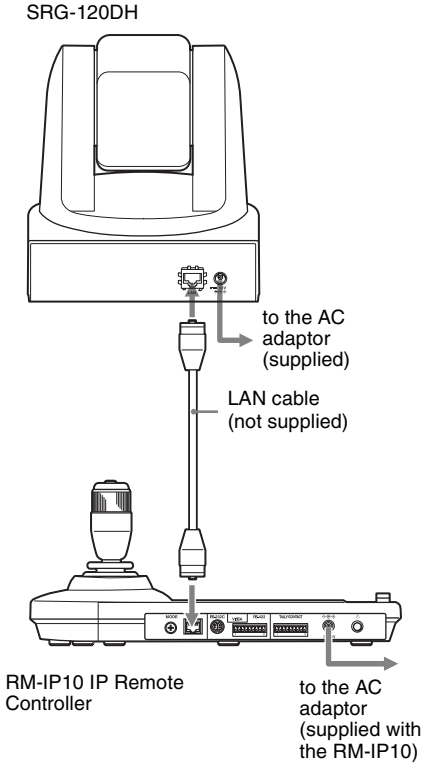

Notes

- In case of LAN connection, make sure that the BOTTOM switch of the camera is set for LAN connection (page 10).
- Use a LAN cable that is compatible with 10BASE-T/100BASE-TX (category 5 or higher, shielded twisted pair) for this connection.
- Use the crossover cable if you want to connect directly to the LAN connector of one camera and one IP remote controller without using a switching hub.

Connecting a Video Monitor, etc., Equipped with HDMI Input Connector

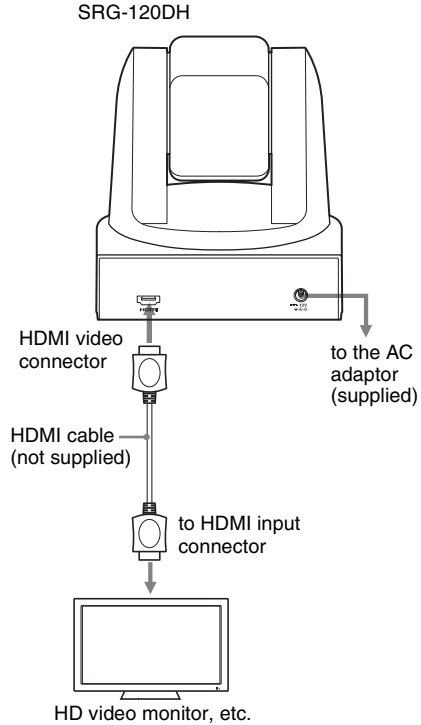

Notes

- Configure the VIDEO FORMAT, based on the specifications of the HD monitor.
- Depending on the performance capabilities of the HDMI cable, some picture noise may occur. For the HDMI cable, a Sony high-speed cable is recommended.
- If the volume of the monitor is set to maximum, a sound may emit for a moment when activated, depending on the product. This is not a malfunction.
- It takes about 15 to 30 seconds to display the image.
- To prevent the HDMI cable disconnecting from the camera (either by its own weight or an external force), it is recommended to secure it with commercially available retaining parts, etc.

Message List

The following messages and indications may appear for this camera. Perform the following as necessary.

Lamp display

| Lamp | Meaning and solution |
|--|--|
| The STANDBY lamp and POWER lamp are lit. | The SYSTEM SELECT switch is set to “no output” (page 9). |
| The STANDBY lamp is lit. | If the camera is moved forcibly, or a finger or other object interferes with camera movement, the camera’s built-in processor may fail to memorize the pan/tilt position. Press the PAN-TILT RESET button to reset the pan/tilt position. |

Screen display

| Message | Meaning and solution |
|---|---|
| PRESET n:OK (“n” is a preset position number between 1 and 16) | This message appears for about 3 seconds when you store camera settings to POSITION 1 to 16. The preset position number of the infrared remote commander is POSITION 1 to 6. |
| RECALL n:OK (“n” is a preset position number between 1 and 16) | This message appears for about 3 seconds when you read the camera settings stored in POSITION 1 to 16. The preset position number of the infrared remote commander is POSITION 1 to 6. |
| RESET n:OK (“n” is a reset position number between 1 and 16) | This message appears for about 3 seconds when you reset camera settings stored in POSITION 1 to 16. The preset position number of the infrared remote commander is POSITION 1 to 6. |
| ONE PUSH WB:OP | During the white balance adjustment in the ONE PUSH white balance mode, this message blinks on the screen. |
| ONE PUSH WB:OK | When the white balance adjustment has been done correctly in the ONE PUSH white balance mode, this message is lit on the screen. |
| ONE PUSH WB:NG | When the white balance adjustment has failed in the ONE PUSH white balance mode, this message blinks on the screen. |

Troubleshooting

Before bringing in your camera for service, check the following as a guide to troubleshooting the problem. If the problem cannot be corrected, consult your Sony dealer.

| Symptom | Cause | Remedy |
|---|--|---|
| The power of the camera is not turned on. | The AC power adaptor is not connected to the DC 12 V connector firmly. | Insert the power cord firmly as far as it will go. |
| | The AC power cord is not inserted firmly into the AC power adaptor or the AC outlet. | Insert the power cord firmly as far as it will go. |
| The picture is not displayed on the video monitor connected to the camera. | The video cable is not connected properly. | Check the connection between the camera and video monitor. |
| | The exposure is not set correctly on the camera. | Set the exposure correctly on the EXPOSURE menu (page 15). |
| | The SYSTEM SELECT switch on the rear of the camera is not set correctly. | Check the selected output signal format of the camera and the input signal format of the connected monitor. |
| Pan, tilt, or zoom cannot be operated. | A menu is displayed on the monitor screen. | Press the DATA SCREEN button on the supplied infrared remote commander to remove the menu from the monitor screen. |
| | The panning or tilting range is limited. | Change the PAN/TILT LIMIT setting on the PAN TILT ZOOM menu (page 17). |
| The EXPOSURE menu cannot be set except for FULL AUTO. | WIDE D is not set to OFF. | After setting the WIDE D to OFF, select the MODE of the EXPOSURE (page 15). |
| The infrared remote commander does not work. | The CAMERA SELECT button you pressed on the infrared remote commander does not match the number set with the IR SELECT switch on the camera. | Press the CAMERA SELECT button corresponding to the IR SELECT switch setting on the camera (page 23). |
| The VISCA CONTROL is not available with a computer connected to the camera. | The computer is not correctly connected to the camera. | Make sure the connection between the computer and camera is made correctly. |
| | | Check that the baud rate setting (9,600 bps or 38,400 bps) is properly made with the BOTTOM switch on the bottom of the camera (page 10). |
| | | Check that the SYSTEM SELECT switch (page 9) is set to a position in which video signals are output. |

| Symptom | Cause | Remedy |
|---|--|--|
| LAN communication is not available with a computer connected to the camera. | The computer is not correctly connected to the camera. | Make sure the connection between the computer and camera is made correctly. |
| | | Check that the VISCA/LAN switch (BOTTOM switch) is set to ON (page 10). |
| | The computer is not correctly set. | Check the precautions in the setting of the dedicated PC application. |
| The camera does not work when connected one-to-one to the IP remote controller. | A crossover cable is not used. | Use a crossover cable for one-to-one LAN connection. |
| The camera cannot be operated at all. | - | Pull out the plug of the power cord from the AC outlet, then reinsert it into the AC outlet after waiting a while. |
| | | Check that the BOTTOM switches 2, 5, 6, 7 and 8 are set to OFF. |

Menu Configuration

The menus of the camera are configured as described below. For more details, refer to the pages in parentheses.

The initial settings of each item are in bold.

| | | | | |
|----------------------------|---------|------------------|--------------|--|
| EXPOSURE (See page 15.) | MODE | FULL AUTO | WIDE D | OFF , LOW, MID, HIGH |
| | | | SLOW SHUTTER | OFF , ON |
| | | | GAIN LIMIT | 9dB, 12dB, 15dB, 18dB, 21dB, 24dB, 27dB, 30dB, 33dB, 36dB, 39dB, 43dB |
| | | BRIGHT | LEVEL | 0, 5~31 |
| | | SHUTTER PRI | SPEED | 1/1, 1/2, 1/4, 1/8, 1/15, 1/30, 1/60, 1/90, 1/100, 1/125, 1/180, 1/250, 1/350, 1/500, 1/725, 1/1000, 1/1500, 1/2000, 1/3000, 1/4000, 1/6000, 1/10000 |
| | | | | 1/1, 1/2, 1/3, 1/6, 1/12, 1/25, 1/50, 1/75, 1/100, 1/120, 1/150, 1/215, 1/300, 1/425, 1/600, 1/1000, 1/1250, 1/1750, 1/2500, 1/3500, 1/6000, 1/10000 |
| | | | GAIN LIMIT | 9dB, 12dB, 15dB, 18dB, 21dB, 24dB, 27dB, 30dB, 33dB, 36dB, 39dB, 43dB |
| | | IRIS PRI | IRIS | CLOSE, F14, F11, F9.6, F8.0, F6.8, F5.6, F4.8, F4.0, F3.4, F2.8, F2.4, F2.0, F1.8 |
| | | | GAIN LIMIT | 9dB, 12dB, 15dB, 18dB, 21dB, 24dB, 27dB, 30dB, 33dB, 36dB, 39dB, 43dB |
| | | MANUAL | GAIN | 0dB, 3dB, 6dB, 9dB, 12dB, 15dB, 18dB, 21dB, 24dB, 27dB, 30dB, 33dB, 36dB, 39dB, 43dB |
| | | | SPEED | 1/1, 1/2, 1/4, 1/8, 1/15, 1/30, 1/60, 1/90, 1/100, 1/125, 1/180, 1/250, 1/350, 1/500, 1/725, 1/1000, 1/1500, 1/2000, 1/3000, 1/4000, 1/6000, 1/10000 |
| | | | | 1/1, 1/2, 1/3, 1/6, 1/12, 1/25, 1/50, 1/75, 1/100, 1/120, 1/150, 1/215, 1/300, 1/425, 1/600, 1/1000, 1/1250, 1/1750, 1/2500, 1/3500, 1/6000, 1/10000 |
| | | | IRIS | CLOSE, F14, F11, F9.6, F8.0, F6.8, F5.6, F4.8, F4.0, F3.4, F2.8, F2.4, F2.0, F1.8 |
| | EX-COMP | | | ON, OFF |
| | LEVEL | | | -7, -6, -5, -4, -3, -2, -1, 0, +1, +2, +3, +4, +5, +6, +7 |

Appendix

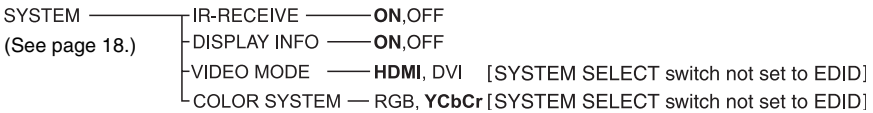
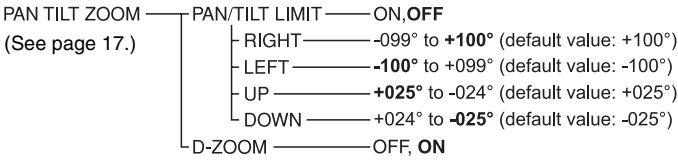
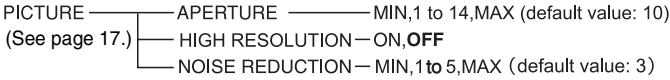
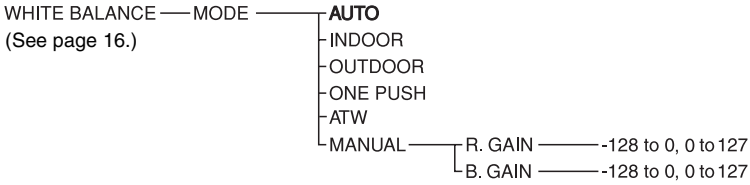

STATUS
(See
page 19.)

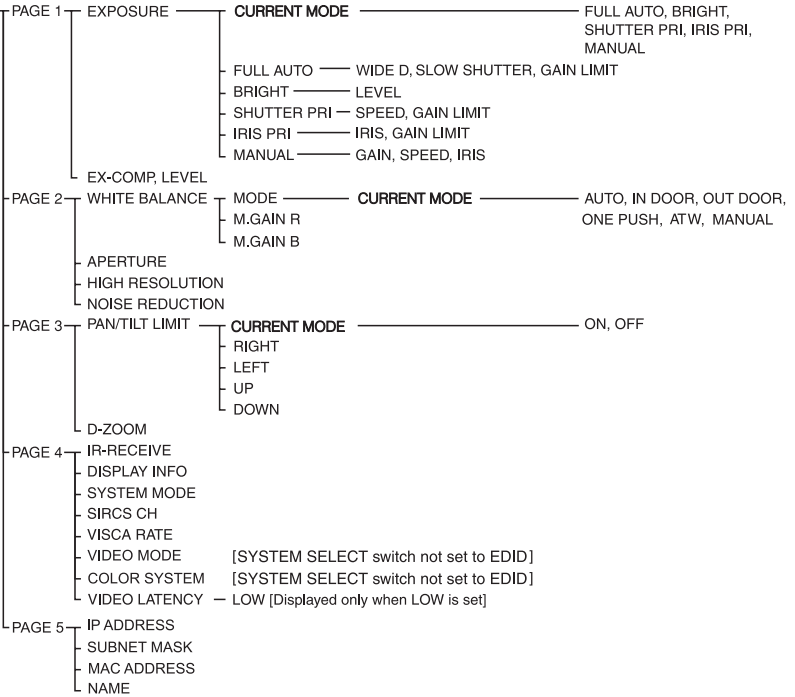

Preset Items

The following items set by using the infrared remote commander and menu items can be stored in the memory of the camera.

Items adjusted with the infrared remote commander

| Preset item | Preset position number | |
|-------------------------------|------------------------|--------|
| | 1 | 2 to 6 |
| Pan/Tilt Position | ● | ○ |
| Zoom Position | ● | ○ |
| Focus Mode Auto/Manual | ● | ○ |
| Focus Position | ● | ○ |
| Backlight Compensation ON/OFF | ● | ○ |

Menu items

| Preset item | Preset position number | |
|----------------------|------------------------|--------|
| | 1 | 2 to 6 |
| EXPOSURE MODE | ● | ○ |
| WIDE D | ● | ○ |
| SLOW SHUTTER | ● | – |
| AE GAIN LIMIT | ● | – |
| BRIGHT LEVEL | ● | ○ |
| SPEED | ● | ○ |
| IRIS | ● | ○ |
| GAIN | ● | ○ |
| EX-COMP ON/OFF | ● | ○ |
| EX-COMP LEVEL | ● | ○ |
| WHITE BALANCE MODE | ● | ○ |
| ONE PUSH WB R/B Data | ● | – |
| MANUAL R/B GAIN | ● | ○ |
| APERTURE | ● | ○ |
| HIGH RESOLUTION | ● | ○ |
| NOISE REDUCTION | ● | ○ |
| PAN/TILT LIMIT | ● | – |
| D-ZOOM | ● | ○ |
| DISPLAY INFO | ● | – |

- :Setting items retained in memory when the power is turned off and then on again. The camera starts with these settings stored in POSITION 1.
- :Setting items retained in memory when the power is turned off and then on again.
- :Setting items cleared from the memory when the power is turned off and then on and reset to the initial settings.

For detailed information on POSITION 1, see “Storing the Camera Settings in Memory — the Presetting Feature” (page 24).

You can store the following items in the memory (POSITION 1), but you can set them only by using the appropriate VISCA command.

- Focus Near Limit
- IR Receive
- IR Receive Return

For detailed information on the VISCA command list, refer to the Technical Manual of the camera. For details on obtaining a Technical Manual, consult your Sony dealer.

The setting of preset numbers 1 to 16 are available for VISCA CONTROL and LAN connection.



Specifications

System

| | |
|-------------------------|--|
| Video signal | 1920×1080p/59.94 1920×1080p/29.97 1920×1080i/59.94 1280×720p/59.94 1280×720p/29.97 1920×1080p/50 1920×1080p/25 1920×1080i/50 1280×720p/50 1280×720p/25 EDID VISCA CONTROL (switched with the SYSTEM SELECT switch) |
| Synchronization | Internal synchronization |
| Image device | 1/2.8 type Exmor CMOS |
| Lens | 12× (optical), 12× (digital) f = 3.9 mm (wide) to 46.8 mm (tele) F1.8 to 2.0 Horizontal angle: 71 degrees (WIDE end) |
| Minimum object distance | 10 mm (13/32 inch) (WIDE end) to 1500 mm (59 1/8 inches) (TELE end) |
| Minimum illumination | 1.8 lux (F1.8, 50 IRE, high- sensitivity mode OFF, 30fps) 3.6 lux (F1.8, 50 IRE, high- sensitivity mode OFF, 60fps) 0.4 lux (F1.8, 50 IRE, high- sensitivity mode ON, 30fps) 0.9 lux (F1.8, 50 IRE, high- sensitivity mode ON, 60fps) |
| Shutter speed | 1/1 to 1/10000 sec. (22 steps) |
| Video S/N | 50 dB |
| Pan/tilt action | Horizontal: ±100 degrees Maximum panning speed: 300 degrees/sec. Vertical: ±25 degrees Maximum tilting speed: 126 degrees/sec. |

Input/output connectors

| | |
|----------------------|--|
| HDMI | (HDMI connector) |
| Control input/output | VISCA IN: Mini DIN 8-pin type, RS-232 VISCA OUT: Mini DIN 8-pin type, RS-232 LAN connector: RJ-45 (8-pin), 10BASE-T/100BASE-TX auto discrimination |
| Power connector | JEITA type4 (DC 12 V) |

General

| | |
|-----------------------|--|
| Input voltage | 12 V DC (10.8 to 13.2 V DC) |
| Power consumption | 16.8 W |
| Operating temperature | 0 °C to +40 °C (+32 °F to +104 °F) |
| Storage temperature | -20 °C to +60 °C (-4 °F to +140 °F) |
| Dimensions | Video camera: 153 mm × 156 mm × 153 mm (6 1/8 inches × 6 1/4 inches × 6 1/8 inches) (w/h/d) Infrared Remote Commander: 56 mm × 26 mm × 210 mm (2 1/4 inches × 1 1/16 inches × 8 3/8 inches) (w/h/d) |
| Installation angle | Less than ±15 degrees to the horizontal surface |

Supplied accessories

| |
|-------------------------------------|
| AC power adaptor (1) |
| AC power cord (1) |
| Infrared Remote Commander (1) |
| Safety Regulations (1) |
| Operating Instructions (CD-ROM) (1) |

Design and specifications are subject to change without notice.

The terms HDMI and HDMI High-Definition Multimedia Interface, and the HDMI Logo are trademarks or registered trademarks of HDMI Licensing LLC in the United States and other countries.

HDMI

Dimensions

Top

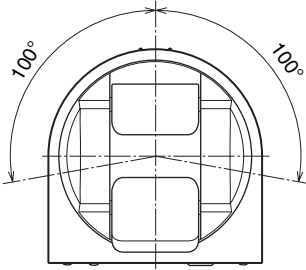

Back

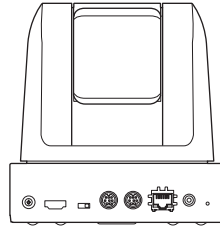

Front

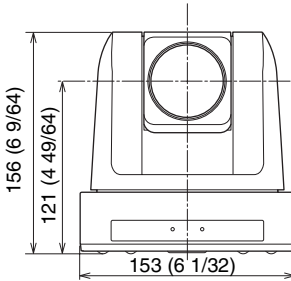

Side

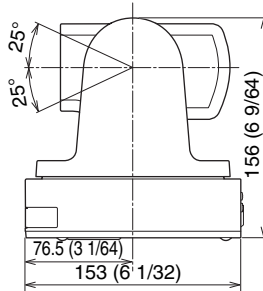

Bottom

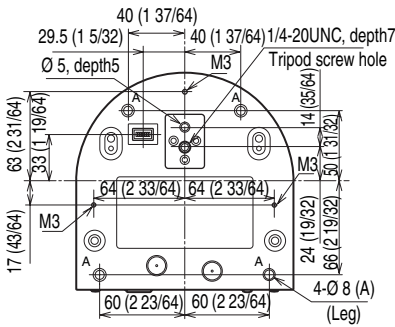

Appendix

Unit: mm (inches)

Pin assignments

VISCA IN connector (mini-DIN 8-pin, female)



| Pin No. | Function |
|---------|-----------|
| 1 | DTR IN |
| 2 | DSR IN |
| 3 | TXD IN |
| 4 | GND |
| 5 | RXD IN |
| 6 | GND |
| 7 | IR OUT R* |
| 8 | IR OUT L* |

* The IR OUT function of pins 7 and 8 are selectable with the BOTTOM switch on the bottom of the camera.

VISCA OUT connector (mini DIN 8-pin, female)



| Pin No. | Function |
|---------|---------------|
| 1 | DTR OUT |
| 2 | DSR OUT |
| 3 | TXD OUT |
| 4 | GND |
| 5 | RXD OUT |
| 6 | GND |
| 7 | No connection |
| 8 | No connection |

License

This software partially supports component uIP. Therefore the following license conditions apply.

Copyright (c) 2001-2006, Adam Dunkels and the Swedish Institute of Computer Science All rights reserved.

Redistribution and use in source and binary forms, with or without modification, are permitted provided that the following conditions are met:

1. Redistributions of source code must retain the above copyright notice, this list of conditions and the following disclaimer.
2. Redistributions in binary form must reproduce the above copyright notice, this list of conditions and the following disclaimer in the documentation and/or other materials provided with the distribution.
3. The name of the author may not be used to endorse or promote products derived from this software without specific prior written permission.

THIS SOFTWARE IS PROVIDED BY THE AUTHOR 'AS IS' AND ANY EXPRESS OR IMPLIED WARRANTIES, INCLUDING, BUT NOT LIMITED TO, THE IMPLIED WARRANTIES OF MERCHANTABILITY AND FITNESS FOR A PARTICULAR PURPOSE ARE DISCLAIMED. IN NO EVENT SHALL THE AUTHOR BE LIABLE FOR ANY DIRECT, INDIRECT, INCIDENTAL, SPECIAL, EXEMPLARY, OR CONSEQUENTIAL DAMAGES (INCLUDING, BUT NOT LIMITED TO, PROCUREMENT OF SUBSTITUTE GOODS OR SERVICES; LOSS OF USE, DATA, OR PROFITS; OR BUSINESS INTERRUPTION) HOWEVER CAUSED AND ON ANY THEORY OF LIABILITY, WHETHER IN CONTRACT, STRICT LIABILITY, OR TORT (INCLUDING NEGLIGENCE OR OTHERWISE) ARISING IN ANY WAY OUT OF THE USE OF THIS SOFTWARE, EVEN IF ADVISED OF THE POSSIBILITY OF SUCH DAMAGE.

<http://www.sony.net/>

Sony Corporation