



KRAMER ELECTRONICS LTD.

USER MANUAL

MODEL:

VS-88HDCPxI
8x8 DVI Matrix Switcher

P/N: 2900-300016 Rev 3

VS-88HDCPxI Quick Start Guide

This page guides you through a basic installation and first-time use of your **VS-88HDCPxI**. For more detailed information, see the **VS-88HDCPxI** user manual, the latest version of which can be downloaded from <http://www.kramerelectronics.com>.

Step 1: Check what's in the box

- VS-88HDCPxI 8x8 DVI Matrix Switcher
- 1 Power cord
- 1 Quick start guide
- 1 IR Remote Control
- 1 User Manual
- Rack "ears"



Save the original box and packaging materials in case your Kramer product needs to be returned to the factory for service.

Step 2: Install the VS-88HDCPxI

Mount the **VS-88HDCPxI** in a rack or place on a table.

Step 3: Connect the inputs and outputs

Always switch off the power to each device before connecting them to your **VS-88HDCPxI**.

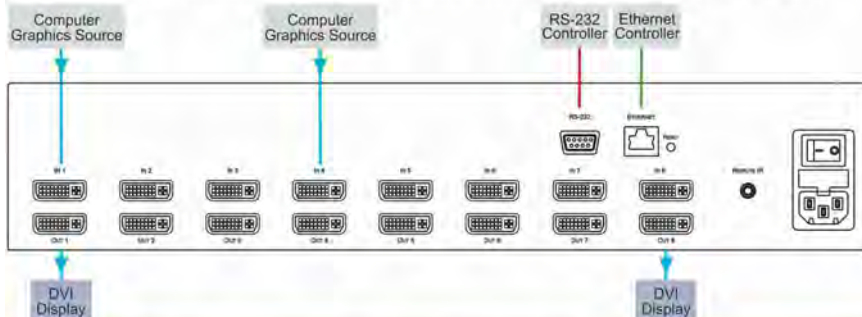

For best results, we recommend that you always use Kramer high-performance cables to connect AV equipment to your **VS-88HDCPxI**.

Step 4: Connect the power



Connect the **VS-88HDCPxI** to the mains electricity and turn the device on. Switch on the power to each device.

Step 5: Operate the VS-88HDCPxI

Configure input and output switching.
Store and recall input/output configurations.

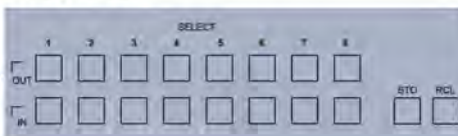

Contents

1	Introduction	1
2	Getting Started	2
2.1	Achieving the Best Performance	2
3	Overview	3
3.1	About HDCP	4
3.2	Defining EDID	4
3.3	Defining the VS-88HDCPxl 8x8 DVI Matrix Switcher	4
3.4	Using the IR Transmitter	7
4	Installing in a Rack	8
5	Connecting the VS-88HDCPxl	9
5.1	Connecting to the VS-88HDCPxl via RS-232	10
5.2	Connecting to the VS-88HDCPxl via Ethernet	10
6	Operating the VS-88HDCPxl 8x8 DVI Matrix Switcher	13
6.1	Routing Inputs to Outputs	13
6.2	Disconnecting the Outputs	13
6.3	Storing and Recalling a Setup	13
6.4	Acquiring the EDID	15
6.5	Locking and Unlocking the Front Panel	17
6.6	Resetting the Ethernet Configuration to Default Values	17
6.7	Controlling Configuration via the Ethernet Port	17
7	Firmware Upgrade	18
8	Technical Specifications	19
9	Default Communication Parameters	20
10	Kramer Protocol 2000	21

Figures

Figure 1:	VS-88HDCPxl 8x8 DVI Matrix Switcher	5
Figure 2:	Connecting to the VS-88HDCPxl Rear Panel	9
Figure 3:	Local Area Connection Properties Window	11
Figure 4:	Internet Protocol (TCP/IP) Properties Window	12
Figure 5:	SELECTOR Buttons	14

1 Introduction

Welcome to Kramer Electronics! Since 1981, Kramer Electronics has been providing a world of unique, creative, and affordable solutions to the vast range of problems that confront the video, audio, presentation, and broadcasting professional on a daily basis. In recent years, we have redesigned and upgraded most of our line, making the best even better!

Our 1,000-plus different models now appear in 11 groups that are clearly defined by function: GROUP 1: Distribution Amplifiers; GROUP 2: Switchers and Matrix Switchers; GROUP 3: Control Systems; GROUP 4: Format/Standards Converters; GROUP 5: Range Extenders and Repeaters; GROUP 6: Specialty AV Products; GROUP 7: Scan Converters and Scalers; GROUP 8: Cables and Connectors; GROUP 9: Room Connectivity; GROUP 10: Accessories and Rack Adapters and GROUP 11: Sierra Products.

Congratulations on purchasing your Kramer **VS-88HDCPxI 8x8 DVI Matrix Switcher**, which is ideal for conference room presentations and advertising applications as well as for rental and staging.

2 Getting Started

We recommend that you:

- Unpack the equipment carefully and save the original box and packaging materials for possible future shipment
- Review the contents of this user manual
- Use Kramer high performance high resolution cables
- Use only the power cord that is supplied with this machine



Go to <http://www.kramerelectronics.com> to check for up-to-date user manuals, application programs, and to check if firmware upgrades are available (where appropriate).

2.1 Achieving the Best Performance

To achieve the best performance:

- Use only good quality connection cables to avoid interference, deterioration in signal quality due to poor matching, and elevated noise levels (often associated with low quality cables)
- Avoid interference from neighboring electrical appliances that may adversely influence signal quality
- Position your Kramer **VS-88HDCPxI** away from moisture, excessive sunlight and dust

3 Overview

The high quality Kramer **VS-88HDCPxI** is an HDCP compatible 8 x 8 DVI Matrix Switcher that accepts up to eight DVI inputs and routes the selected DVI input signal to any or all of eight DVI outputs.

DVI-D (Digital). Note that only the digital signal (DVI D) is available on the DVI connector.

The **VS-88HDCPxI** features:

- Support for up to 2.25Gbps bandwidth per graphic channel
Suitable for resolutions up to UXGA at 60Hz, and for all HD resolutions
- Support for HDCP (High Definition Digital Content Protection)
- HDMI Support – HDMI (V1.4a with Deep Color, x.v.Color™, 3D Pass-Through, HDMI Compressed Audio Channels)
- EDID PassThru that passes EDID/HDCP signals from source to display
- Kramer reKlocking™ & Equalization Technology that rebuilds the digital signal to travel longer distances
- A PANEL LOCK button to prevent unwanted tampering with the buttons on the front panel
- 16 preset memory locations for quick access to common configurations
- 2U height that fits into a standard 19" professional rack enclosure

You can control the **VS-88HDCPxI** using the front panel buttons or remotely via:

- RS-232 serial commands transmitted by a touch screen system, PC or other serial controller
- The Kramer infrared remote control transmitter
- The Ethernet port

3.1 About HDCP

The HDCP (High-Bandwidth Digital Content Protection) standard (developed by Intel), protects digital video and audio signals transmitted over DVI or DVI connections between two HDCP-enabled devices to eliminate the reproduction of copyrighted material. To protect copyright holders (such as movie studios) from having their programs copied and shared, the HDCP standard provides for the secure and encrypted transmission of digital signals.

3.2 Defining EDID

The Extended Display Identification Data (EDID) is a data-structure, provided by a display, to describe its capabilities to a DVI source.

Defined by a standard published by the Video Electronics Standards Association (VESA).

The EDID enables the **VS-88HDCPxI** to “know” what kind of monitor is connected to the output. The EDID includes the manufacturer’s name, the product type, the timing data supported by the display, the display size, luminance data and (for digital displays only) the pixel mapping data. See [Section 6.4](#) for details of how to acquire the EDID.

3.3 Defining the VS-88HDCPxI 8x8 DVI Matrix Switcher

This section defines the **VS-88HDCPxI**.

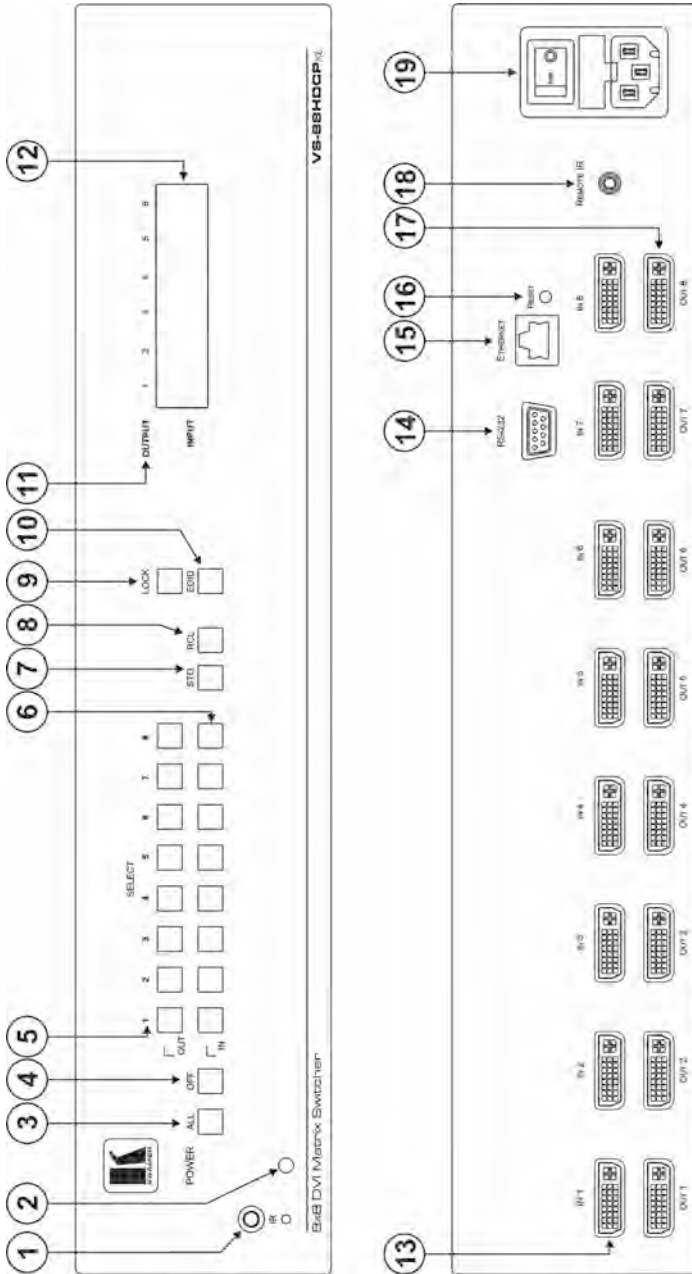

Figure 1: VS-88HDCPxI 8x8 DVI Matrix Switcher

VS-88HDCPxI Front Panel Features		
#	Feature	Function
1	IR Receiver and LED	IR remote control sensor. LED lights yellow when receiving an IR signal
2	POWER LED	Lights green when the unit is turned on
3	ALL Button	Press to select all inputs or all outputs (see Section 6.1)
4	OFF Button	Press to disconnect one or all outputs (see Section 6.2)
5	SELECT OUT Buttons	Press to select an output (from 1 to 4)
6	SELECT IN Buttons	Press to select an input (from 1 to 8)
7	STO Button	Press to store a switching configuration
8	RCL Button	Press to recall a switching configuration
9	LOCK Button	Press and hold to lock the front panel buttons and to acquire the EDID (see Section 6.5). Press and hold a second time to unlock the front panel buttons
10	EDID Button	Press to acquire the EDID
11	OUTPUT 1 to 6	Indicates the output channels and their respective input selections on the 7-segment display
12	INPUT 7-segment Display	Number shown on the display indicates the relevant input channel

VS-88HDCPxI Rear Panel Features		
#	Feature	Function
13	INPUT DVI Connectors	Connect to the DVI sources (from 1 to 8)
14	RS-232 9-pin D-sub (F) Connector	Connect to a PC or the serial remote controller (see Section 9)
15	ETHERNET RJ-45 Connector	Connect to a PC or other Ethernet controller via a LAN (see Section 9)
16	RESET Button	Press and hold to reset the Ethernet configuration to its factory default values (see Section 9)
17	OUTPUT DVI Connectors	Connect to the DVI acceptors (from 1 to 4)
18	REMOTE IR 3.5mm Mini Jack	Connect to an external IR receiver unit for controlling the machine via an IR remote controller (instead of using the front panel IR receiver), see Section 3.4
19	Mains Power Connector with Switch and Fuse	Connect to the AC mains supply and use the switch to turn the device on or off

3.4 Using the IR Transmitter

You can use the **RC IR3** IR transmitter to control the machine via the built-in IR receiver on the front panel or, instead, via an optional external IR receiver (Model: C-A35M/IRR-50). The external IR receiver can be located up to 15 meters away from the machine. This distance can be extended to up to 60 meters when used with three extension cables (Model: C-A35M/A35F-50).

Before using the external IR receiver, be sure to arrange for your Kramer dealer to insert the internal IR connection cable (P/N: 505-70434010-S) with the 3.5mm connector that fits into the REMOTE IR opening on the rear panel. Connect the external IR receiver to the REMOTE IR 3.5mm connector.

4 Installing in a Rack

Before installing in a rack, be sure that the environment is within the recommended range:

OPERATING TEMPERATURE:	0° to +55°C (32° to 131°F)
STORAGE TEMPERATURE:	-45° to +72°C (-49° to 162°F)
HUMIDITY:	10% to 90%, RHL non-condensing



CAUTION!

When installing on a 19" rack, avoid hazards by taking care that:

1. It is located within the recommended environmental conditions, as the operating ambient temperature of a closed or multi unit rack assembly may exceed the room ambient temperature.
2. Once rack mounted, enough air will still flow around the machine.
3. The machine is placed straight in the correct horizontal position.
4. You do not overload the circuit(s). When connecting the machine to the supply circuit, overloading the circuits might have a detrimental effect on overcurrent protection and supply wiring. Refer to the appropriate nameplate ratings for information. For example, for fuse replacement, see the value printed on the product label.
5. The machine is earthed (grounded) in a reliable way and is connected only to an electricity socket with grounding. Pay particular attention to situations where electricity is supplied indirectly (when the power cord is not plugged directly into the socket in the wall), for example, when using an extension cable or a power strip, and that you use only the power cord that is supplied with the machine.

To rack-mount a machine:

1. Attach both ear brackets to the machine. To do so, remove the screws from each side of the machine (5 on each side), and replace those screws through the ear brackets.

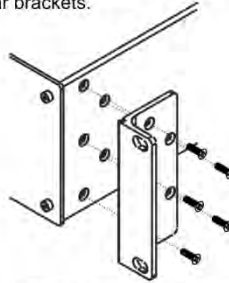

2. Place the ears of the machine against the rack rails, and insert the proper screws (not provided) through each of the four holes in the rack ears.

Note:

- In some models, the front panel may feature built-in rack ears
- Detachable rack ears can be removed for desktop use
- Always mount the machine in the rack before you attach any cables or connect the machine to the power
- If you are using a Kramer rack adapter kit (for a machine that is not 19"), see the Rack Adapters user manual for installation instructions available from our Web site

5 Connecting the VS-88HDCPxI



Always switch off the power to each device before connecting it to your **VS-88HDCPxI**. After connecting your **VS-88HDCPxI**, connect its power and then switch on the power to each device.

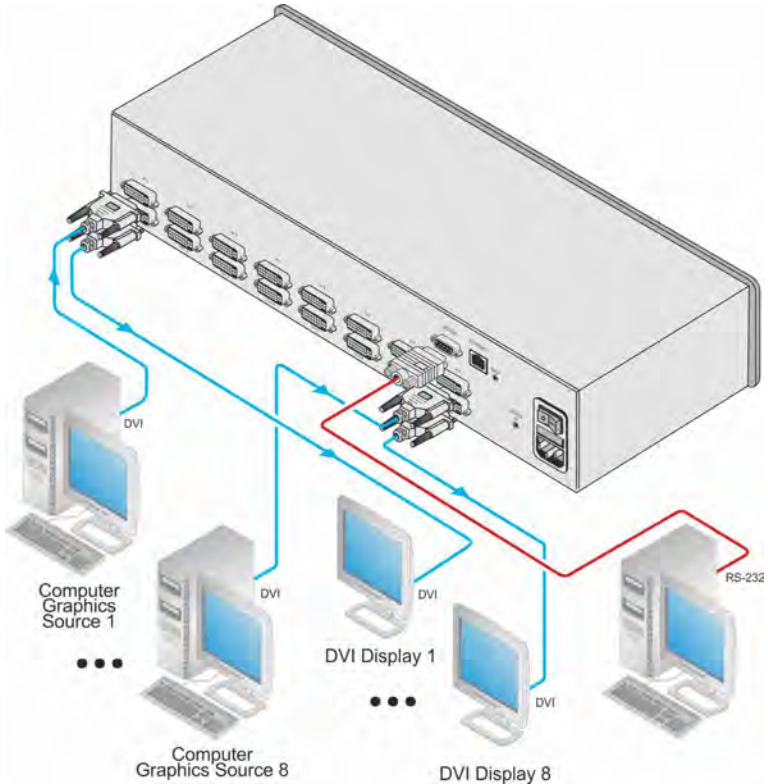

Figure 2: Connecting to the VS-88HDCPxI Rear Panel

To connect the VS-88HDCPxI as illustrated in the example in [Figure 2](#):

1. Connect up to eight DVI sources (for example, DVD players) to the IN DVI connectors.
2. Connect the OUT DVI connectors to up to eight DVI acceptors (for example, DVI displays).

3. If required, connect a PC and/or controller to the RS-232 port (see [Section 5.1](#)) and/or the Ethernet port (see [Section 5.2](#)).
4. If required, acquire the EDID (see [Section 6.4](#)).



The power cord is not shown in [Figure 2](#).

5.1 Connecting to the VS-88HDCPxI via RS-232

You can connect to the **VS-88HDCPxI** via an RS-232 connection using, for example, a PC. Note that a null-modem adapter/connection is not required.

To connect to the VS-88HDCPxI via RS-232:

- Connect the RS-232 9-pin D-sub rear panel port on the **VS-88HDCPxI** unit via a 9-wire straight cable (only pin 2 to pin 2, pin 3 to pin 3, and pin 5 to pin 5 need to be connected) to the RS-232 9-pin D-sub port on your PC

5.2 Connecting to the VS-88HDCPxI via Ethernet

You can connect the **VS-88HDCPxI** via Ethernet using a crossover cable (see [Section 5.2.1](#)) for direct connection to the PC or a straight-through cable (see [Section 5.2.2](#)) for connection via a network hub or network router.

After connecting the Ethernet port, you have to install and configure the port. For detailed instructions, see the "Ethernet Configuration (FC-11) guide.pdf" file in the technical support section at <http://www.kramerelectronics.com>

5.2.1 Connecting the Ethernet Port directly to a PC

You can connect the Ethernet port on the **VS-88HDCPxI** to the Ethernet port on your PC using a crossover cable with RJ-45 connectors.



This type of connection is recommended for identifying the **VS-88HDCPxI**

After connecting the Ethernet port, configure your PC as follows:

1. Right-click the *My Network Places* icon on your desktop.
2. Select *Properties*.

3. Right-click *Local Area Connection Properties*.
4. Select *Properties*.
The *Local Area Connection Properties* window appears.
5. Select the *Internet Protocol (TCP/IP)* and click the *Properties* button (see [Figure 3](#)).

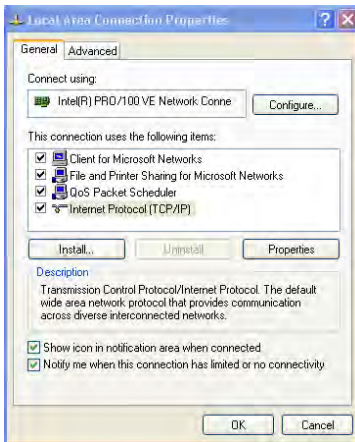

Figure 3: Local Area Connection Properties Window

6. Select *Use the following IP Address*, and fill in the details as shown in [Figure 4](#).
7. Click *OK*.

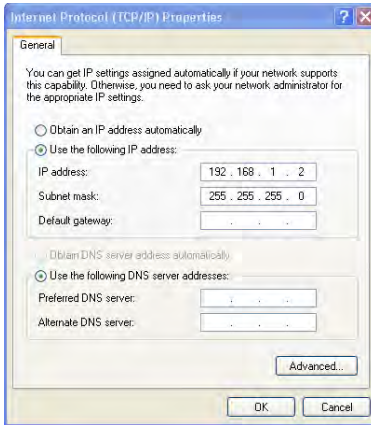

Figure 4: Internet Protocol (TCP/IP) Properties Window

5.2.2 Connecting the Ethernet Port to a Network Hub

You can connect the Ethernet port on the **VS-88HDCPxI** to the Ethernet port on a network hub or router using a straight-through cable with RJ-45 connectors.

5.2.3 Control Configuration via the Ethernet Port

To control several units via the Ethernet, connect the Master unit (Machine # 1) via the Ethernet port to the LAN port of your PC. Use your PC initially to configure the settings (see [Section 5.2.1](#)).

6 Operating the VS-88HDCPxI 8x8 DVI Matrix Switcher

This section describes how to:

- Route inputs to outputs (see [Section 6.1](#))
- Disconnect outputs (see [Section 6.2](#))
- Store and recall a setup (see [Section 6.3](#))
- Acquire the EDID (see [Section 6.4](#))
- Lock and unlock the front panel (see [Section 6.5](#))
- Reset the Ethernet configuration to default values (see [Section 6.6](#))
- Control the machine via the Ethernet port (see [Section 6.7](#))

6.1 Routing Inputs to Outputs

To route an input to an output:

- Press an OUT key, followed by an IN key to route this input to that output

To route one input to all outputs:

- Press ALL followed by an IN button. The input is routed to all outputs

6.2 Disconnecting the Outputs

To disconnect one output:

- Press the OUT button of the output to disconnect and press OFF

To disconnect all outputs at once:

- Press the ALL button and then press OFF. This disconnects all the outputs

6.3 Storing and Recalling a Setup

You can use the STO and RCL buttons to store up to 12 setups and then recall them as illustrated in [Figure 5](#).

IN 1 is used for setup number 1 and OUT 1 is used for setup number 7.

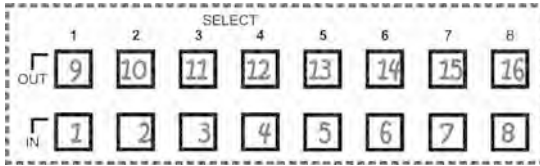

Figure 5: SELECTOR Buttons



The gray numbers (1 to 16) in [Figure 5](#) that illustrate the corresponding store/recall configuration numbers are for the purpose of illustration only and do not actually appear on the buttons.

To store a setup:

1. Set the device to the desired setup.
For example, press the OUT 3 button and IN 4 button.
You can set any of the IN-OUT buttons
2. Press the STO button.
The STO button flashes.
3. Select an OUT or IN SELECT button to store the machine setup (for example, OUT 4).
4. Press the LOCK button to store the current setup.
In this example, the OUT 4 button stores the setup.
Press the LOCK button within 10 seconds as the store operation times out automatically after this period.

To recall a setup:

1. Press the RCL button.
The RCL button flashes.
2. Press the relevant OUT or IN button that stored the setup.
In this example, press OUT 4.
3. Press the LOCK button to recall the stored setup.

6.4 Acquiring the EDID

You can acquire the EDID from:

- A single connected output (see [Section 6.4.1](#))
- Several sets of inputs and outputs (see [Section 6.4.2](#))
- The default EDID (see [Section 6.4.3](#))

6.4.1 Acquiring an EDID from a Single Connected Output

To acquire or change the EDID of a new output display:

1. Connect the required acceptor to the output from which you want to acquire the EDID.
2. Press the EDID and STO buttons simultaneously and hold them for 3 seconds.
Both buttons flash.
3. Press the IN SELECT button to which the EDID is to be copied.
The selected input number flashes on the display.
4. Select the OUT SELECT button from which the EDID is to be acquired.
5. Press the EDID button.
The EDID has been captured when the display returns to normal.

6.4.2 Acquiring an EDID from Several Sets of Inputs and Outputs

To acquire the EDID from several sets of inputs and outputs (for example, OUT 1 to IN 1 and OUT 4 to IN 3):

1. Connect the required acceptors to the outputs from which you want to acquire the EDID.
2. Press the EDID and STO buttons simultaneously and hold them for 3 seconds.
Both buttons flash.

3. Press the SELECT IN button to which the first EDID is to be copied (for example, IN 1).
The selected input number flashes on the display.
4. Press the SELECT OUT button from which the first EDID is to be acquired (for example, OUT 1).
5. Press the SELECT IN 1 button again.
The IN 1 button stops flashing.
6. Press another SELECT IN to which the next EDID is to be copied (for example, IN 3).
The selected input number flashes on the display.
7. Press the SELECT OUT button from which the next EDID is to be acquired (for example, OUT 4).
8. Press the SELECT IN 3 button again.
The IN 3 button stops flashing.
9. Press the SELECT IN buttons to which you want to copy the EDID (for example, IN 1 and IN 3).
10. Insure that the relevant input numbers flash on the display.
11. Press the EDID button.
The process is complete when the display returns to normal.

6.4.3 Acquiring the Default EDID

To reset to the default EDID:

1. Press the EDID and STO buttons simultaneously and hold them for 3 seconds.
Both buttons flash.
2. Press the SELECT IN button to which the EDID will be copied.
The selected input number flashes on the display.

3. Press the OFF button until a "0" (zero) appears on the display.
4. Press the EDID button.

The process is complete when the display returns to normal.

6.5 Locking and Unlocking the Front Panel

To prevent unintended tampering with the unit via the front panel buttons, lock your **VS-88HDCPxI**.

To lock the VS-88HDCPxI:

- Press the PANEL LOCK button on the front

6.6 Resetting the Ethernet Configuration to Default Values

Power cycle the unit while holding in the Factory Reset button, located on the rear panel of the unit.

6.7 Controlling Configuration via the Ethernet Port

To control several units via Ethernet, connect the Master unit (Machine # 1) Ethernet port on your PC. Use your PC to configure the initial settings (see [Section 5.2](#)).

7 Firmware Upgrade

Instructions for upgrading the firmware can be found in the *STC Firmware Upgrade* document.

8 Technical Specifications

INPUTS:	8 DVI connectors
OUTPUTS:	8 DVI connectors
BANDWIDTH:	Supports up to 2.25Gbps bandwidth per graphic channel
COMPLIANCE WITH STANDARDS:	Supports DVI and HDCP
MAX RESOLUTION:	Up to UXGA; 1080p
POWER SOURCE:	100–240VAC; 50/60Hz, 33VA
CONTROLS:	Front panel buttons, Infrared remote control transmitter, RS-232, Ethernet
DIMENSIONS:	19" x 7" x 2U W, D, H
WEIGHT:	2.5kg (5 5lbs) approx.
ACCESSORIES:	Power cord, IR transmitter, rack "ears"
OPTIONS:	Kramer DVI cables, External remote IR receiver cable For best results, use Kramer cables such as the C-HM/DM series
Specifications are subject to change without notice at http://www.kramerelectronics.com	

9 Default Communication Parameters

RS-232 Protocol 2000	
Baud Rate:	9600
Data Bits:	8
Stop Bits:	1
Parity:	None
Command Format:	HEX
Example (Output 1 to Input 1):	0x01, 0x81, 0x81, 0x81
Ethernet	
IP Address:	192.168.1.39
TCP Port Number:	5000
Network Mask:	255.255.255.0
Default Gateway:	192.168.1.1

10 Kramer Protocol 2000

The Kramer Protocol 2000 RS-232/RS-485 communication uses four bytes of information as defined below.

MSB		DESTINATION INSTRUCTION						LSB
0	D	N5	N4	N3	N2	N1	N0	
7	6	5	4	3	2	1	0	

1st byte

		INPUT					
1	I6	I5	I4	I3	I2	I1	I0
7	6	5	4	3	2	1	0

2nd byte

		OUTPUT					
1	O6	O5	O4	O3	O2	O1	O0
7	6	5	4	3	2	1	0

3rd byte

		MACHINE NUMBER					
1	OVR	X	M4	M3	M2	M1	M0
7	6	5	4	3	2	1	0

4th byte

1st BYTE: Bit 7 – Defined as 0.

D – "DESTINATION": 0 - for sending information to the switchers (from the PC);

1 - for sending to the PC (from the switcher).

N5 N0 – "NSTRUCTION"

The function that is to be performed by the switcher(s) is defined by the NSTRUCTION (6 bits). Similarly, if a function is performed via the machine's keyboard, then these bits are set with the INSTRUCTION NO., which was performed. The instruction codes are defined according to the table below (INSTRUCTION NO. is the value to be set for N5 N0).

2nd BYTE: Bit 7 – Defined as 1.

I6 I0 – "NPUT".

When switching (ie. instruction codes 1 and 2), the NPUT (7 bits) is set as the input number which is to be switched. Similarly, if switching is done via the machine's front-panel, then these bits are set with the INPUT NUMBER which was switched. For other operations, these bits are defined according to the table.

3rd BYTE: Bit 7 – Defined as 1.

O6 O0 – "OUTPUT".

When switching (ie. instruction codes 1 and 2), the OUTPUT (7 bits) is set as the output number which is to be switched. Similarly, if switching is done via the machine's front-panel, then these bits are set with the OUTPUT NUMBER which was switched. For other operations, these bits are defined according to the table.

4th BYTE: Bit 7 – Defined as 1.

Bit 5 – Don't care.

OVR – Machine number override.

M4 M0 – MACHINE NUMBER.

Used to address machines in a system via their machine numbers. When several machines are controlled from a single serial port, they are usually configured together with each machine having an individual machine number. If the OVR bit is set, then all machine numbers will accept (implement) the command, and the addressed machine will reply. For a single machine controlled via the serial port, always set M4 M0 = 1, and make sure that the machine itself is configured as MACHINE NUMBER = 1.



All the values in the table are decimal, unless otherwise stated

Instruction Codes for Protocol 2000				
Instruction		Definition for Specific Instruction		Notes
#	Description	Input	Output	
0	RESET VIDEO	0	0	1
1	SWITCH VIDEO	Set equal to video input which is to be switched (0 = disconnect)	Set equal to video output which is to be switched (0 = to all the outputs)	2, 15
3	STORE VIDEO STATUS	Set as SETUP #	0 - to store 1 - to delete	2, 3, 15
4	RECALL V DEO STATUS	Set as SETUP #	0	2, 3, 15
5	REQUEST STATUS OF A V DEO OUTPUT	Set as SETUP #	Equal to output number whose status is reqd	4, 3
15	REQUEST WHETHER SETUP IS DEFINED / VALID INPUT IS DETECTED	SETUP # or Input #	0 - for checking if setup is defined 1 - for checking if input is valid	8
30	LOCK FRONT PANEL	0 - Panel unlocked 1 - Panel locked	0	2
31	REQUEST WHETHER PANEL IS LOCKED	0	0	16
61	DENT FY MACHINE	1 - video machine name 2 - audio machine name 3 - video software version 4 - audio software version 5 - RS422 controller name 6 - RS422 controller version 7 - remote control name 8 - remote software version 9 - Protocol 2000 revision	0 - Request first 4 digits 1 - Request first suffix 2 - Request second suffix 3 - Request third suffix 10 - Request first prefix 11 - Request second prefix 12 - Request third prefix	13
62	62	DEF NE MACH NE	1 - number of inputs 2 - number of outputs 3 - number of setups	1 - for video 2 - for audio 3 - for SDI 4 - for remote panel 5 - for RS-422 controller

NOTES on the above table:

NOTE 1 - When the master switcher is reset, (e.g. when it is turned on), the reset code is sent to the PC. If this code is sent to the switchers, it will reset according to the present power-down settings.

NOTE 2 - These are bi-directional definitions. That is, if the switcher receives the code, it will perform the instruction; and if the instruction is performed (due to a keystroke operation on the front panel), then these codes are sent. For example, if the HEX code

01 85 88 83
was sent from the PC, then the switcher (machine 3) will switch input 5 to output 8. If the user switched input 1 to output 7 via the front panel keypad, then the switcher will send HEX codes:

41 81 87 83
to the PC.

When the PC sends one of the commands in this group to the switcher, then, if the instruction is valid, the switcher replies by sending to the PC the same four bytes that it was sent (except for the first byte, where the DEST NATION bit is set high).

NOTE 3 - SETUP # 0 is the present setting. SETUP # 1 and higher are the settings saved in the switcher's memory, (i.e. those used for Store and Recall).

NOTE 4 - The reply to a "REQUEST" instruction is as follows: the same instruction and NPUT codes as were sent are returned, and the OUTPUT is assigned the value of the requested parameter. The replies to instructions 10 and 11 are as per the definitions in instructions 7 and 8 respectively. For example, if the present status of machine number 5 is breakaway setting, then the reply to the HEX code

0B 80 80 85

would be HEX codes

4B 80 81 85

NOTE 8 - The reply is as in TYPE 3 above, except that here the OUTPUT is assigned with the value 0 if the setup is not defined / no valid input is detected; or 1 if it is defined / valid input is detected.

NOTE 13 - This is a request to identify the switcher/s in the system. If the OUTPUT is set as 0, and the NPUT is set as 1, 2, 5 or 7, the machine will send its name. The reply is the decimal value of the INPUT and OUTPUT. For example, for a 2216, the reply to the request to send the audio machine name would be (HEX codes):

7D 96 90 81 (i.e. 128dec+ 22dec for 2nd byte, and 128dec+ 16dec for 3rd byte).

If the request for identification is sent with the NPUT set as 3 or 4, the appropriate machine will send its software version number. Again, the reply would be the decimal value of the INPUT and OUTPUT - the INPUT representing the number in front of the decimal point, and the OUTPUT representing the number after it. For example, for version 3.5, the reply to the request to send the version number would be (HEX codes):

7D 83 85 81 (i.e. 128dec+ 3dec for 2nd byte, 128dec+ 5dec for 3rd byte).

If the OUTPUT is set as 1, then the ASCII coding of the lettering following the machine's name is sent. For example, for the VS-7588YC, the reply to the request to send the first suffix would be (HEX codes):

7D D9 C3 81 (i.e. 128dec+ ASCII for "Y"; 128dec+ ASCII for "C").

NOTE 14 - The number of inputs and outputs refers to the specific machine which is being addressed, not to the system. For example, if six 16X16 matrices are configured to make a 48X32 system (48 inputs, 32 outputs), the reply to the HEX code

3E 82 81 82 (ie. request the number of outputs)

would be HEX codes

7E 82 90 82

ie. 16 outputs

NOTE 15 - When the OVR bit (4th byte) is set, then the "video" commands have universal meaning. For example, instruction 1 (SWITCH VIDEO) will cause all units (including audio, data, etc.) to switch. Similarly, if a machine is in "FOLLOW" mode, it will perform any "video" instruction.

NOTE 16 - The reply to the "REQUEST WHETHER PANEL IS LOCKED" is as in NOTE 4 above, except that here the OUTPUT is assigned with the value 0 if the panel is unlocked, or 1 if it is locked.

LIMITED WARRANTY

We warrant this product free from defects in material and workmanship under the following terms.

HOW LONG IS THE WARRANTY

Labor and parts are warranted for seven years from the date of the first customer purchase.

WHO IS PROTECTED?

Only the first purchase customer may enforce this warranty.

WHAT IS COVERED AND WHAT IS NOT COVERED

Except as below, this warranty covers all defects in material or workmanship in this product. The following are not covered by the warranty:

1. Any product which is not distributed by us or which is not purchased from an authorized Kramer dealer. If you are uncertain as to whether a dealer is authorized, please contact Kramer at one of the agents listed in the Web site www.kramerelectronics.com.
2. Any product, on which the serial number has been defaced, modified or removed, or on which the WARRANTY VOID IF TAMPERED sticker has been torn, reattached, removed or otherwise interfered with.
3. Damage, deterioration or malfunction resulting from:
 - i) Accident, misuse, abuse, neglect, fire, water, lightning or other acts of nature
 - ii) Product modification, or failure to follow instructions supplied with the product
 - iii) Repair or attempted repair by anyone not authorized by Kramer
 - iv) Any shipment of the product (claims must be presented to the carrier)
 - v) Removal or installation of the product
 - vi) Any other cause, which does not relate to a product defect
 - vii) Cartons, equipment enclosures, cables or accessories used in conjunction with the product

WHAT WE WILL PAY FOR AND WHAT WE WILL NOT PAY FOR

We will pay labor and material expenses for covered items. We will not pay for the following:

1. Removal or installations charges.
2. Costs of initial technical adjustments (set-up), including adjustment of user controls or programming. These costs are the responsibility of the Kramer dealer from whom the product was purchased.
3. Shipping charges.

HOW YOU CAN GET WARRANTY SERVICE

1. To obtain service on you product, you must take or ship it prepaid to any authorized Kramer service center.
2. Whenever warranty service is required, the original dated invoice (or a copy) must be presented as proof of warranty coverage, and should be included in any shipment of the product. Please also include in any mailing a contact name, company, address, and a description of the problem(s).
3. For the name of the nearest Kramer authorized service center, consult your authorized dealer.

LIMITATION OF IMPLIED WARRANTIES

All implied warranties, including warranties of merchantability and fitness for a particular purpose, are limited in duration to the length of this warranty.

EXCLUSION OF DAMAGES

The liability of Kramer for any effective products is limited to the repair or replacement of the product at our option. Kramer shall not be liable for:

1. Damage to other property caused by defects in this product, damages based upon inconvenience, loss of use of the product, loss of time, commercial loss; or:
2. Any other damages, whether incidental, consequential or otherwise. Some countries may not allow limitations on how long an implied warranty lasts and/or do not allow the exclusion or limitation of incidental or consequential damages, so the above limitations and exclusions may not apply to you.

This warranty gives you specific legal rights, and you may also have other rights, which vary from place to place.

NOTE: All products returned to Kramer for service must have prior approval. This may be obtained from your dealer.

This equipment has been tested to determine compliance with the requirements of:

- EN-50081: "Electromagnetic compatibility (EMC);
generic emission standard.
Part 1: Residential, commercial and light industry"
- EN-50082: "Electromagnetic compatibility (EMC) generic immunity standard.
Part 1: Residential, commercial and light industry environment".
- CFR-47: FCC* Rules and Regulations:
Part 15: "Radio frequency devices
Subpart B Unintentional radiators"

CAUTION!

- Servicing the machines can only be done by an authorized Kramer technician. Any user who makes changes or modifications to the unit without the expressed approval of the manufacturer will void user authority to operate the equipment.
- Use the supplied DC power supply to feed power to the machine.
- Please use recommended interconnection cables to connect the machine to other components.

* FCC and CE approved using STP cable (for twisted pair products)



For the latest information on our products and a list of Kramer distributors, visit our Web site where updates to this user manual may be found.

We welcome your questions, comments, and feedback.

Web site: www.kramerelectronics.com

E-mail: info@kramerel.com



SAFETY WARNING

Disconnect the unit from the power supply before opening and servicing