

Kramer Electronics, Ltd.

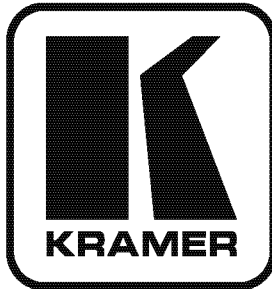

USER MANUAL

Model:

VP-88K

8x8 RGBHV / Balanced Audio Matrix Switcher

Contents

1	Introduction	1
2	Getting Started	1
2.1	Quick Start	1
3	Overview	3
4	Defining the RGBHV/Balanced Audio Matrix Switcher	4
4.1	Using the IR Transmitter	8
5	Installing in a Rack	8
6	Connecting the RGBHV/Balanced Audio Matrix Switcher	9
6.1	Wiring a Balanced/Unbalanced Stereo Audio Input/Output	10
6.2	Connecting to the VP-88K via RS-232	11
6.3	Connecting to the VP-88K via RS-485	12
6.4	Connecting to the VP-88K via the Ethernet Port	12
6.4.1	Connecting Directly via the Ethernet Port	12
6.4.2	Connecting via a Network Hub, Switch, or Router	14
6.4.3	Configuring the Ethernet Port on the VP-88K	14
6.5	Setting the VP-88K DIP-switches	16
7	Operating the VP-88K	18
7.1	Displaying the Configuration of the VP-88K	18
7.2	Switching Outputs to Inputs	18
7.3	Confirming Settings	18
7.3.1	Toggling between At Once and Confirm Modes	19
7.3.2	Confirming a Switching Action	19
7.4	Understanding the 7-Segment Status Display Information	20
7.4.1	Status Display Immediately After Power is Turned On	20
7.4.2	Status Display During Normal Operation	20
7.4.3	Status Display During Audio Gain Level Setting	21
7.5	Choosing the Audio-Follow-Video or Breakaway Option	21
7.5.1	Setting the Audio-Follow-Video Option	21
7.5.2	Setting the Breakaway Option	22
7.6	Storing/Recalling Input-Output Configurations	22
7.6.1	Storing an Input-Output Configuration	22
7.6.2	Recalling an Input-Output Configuration	22
7.6.3	Deleting an Input-Output Configuration	23
7.7	The Audio Input/Output Gain Control	23
7.8	Resetting the Unit	24
7.9	Selecting the Genlock Source	24
8	Controlling the VP-88K	25
8.1	Controlling the VP-88K via RS-232	25
8.2	Controlling the VP-88K via RS-485	26
8.3	Controlling the VP-88K via Ethernet	27

9	Connecting to the VP-88K via your Browser	28
9.1	Connecting to the VP-88K User Manual via your Browser	28
9.2	The Main Switching Matrix Page	30
9.2.1	Switching an Input to an Output	30
9.2.2	Setting the AFV Mode	31
9.2.3	Operating in the Offline Mode	32
9.2.4	Storing and Recalling Setups	33
9.2.5	Locking the Front Panel Buttons	35
9.3	Audio Input Gain Control Page	35
9.4	The Configuration Page	36
10	Flash Memory Upgrade	37
11	Technical Specifications	38
12	Communication Parameters	39
13	Tables of ASCII Codes for Serial Communication (Protocol 3000)	39
14	Tables of Hex Codes for Serial Communication (Protocol 2000)	40
15	Kramer Protocol	42
15.1	Switching Protocols	42
15.1.1	Switching Protocols via the Front Panel Buttons	43
15.1.2	Switching Protocols via Protocol Commands	43
15.2	Kramer Protocol 3000	43
15.2.1	Protocol 3000 Syntax	43
15.2.2	Command Parts Details	45
15.3	Kramer Protocol 2000	51

Figures

Figure 1: VP-88K RGBHV/Balanced Audio Matrix Switcher Front Panel	4
Figure 2: VP-88K RGBHV/Balanced Audio Matrix Switcher Rear View	6
Figure 3: Connecting the VP-88K RGBHV/Balanced Audio Matrix Switcher	9
Figure 4: Wiring a Balanced Stereo Audio Input/Output	10
Figure 5: Wiring an Unbalanced Stereo Audio Output	11
Figure 6: Wiring an Unbalanced Source to a Balanced Input	11
Figure 7: Connecting to the VP-88K via RS-232 using a PC	11
Figure 8: Local Area Connection Properties Window	13
Figure 9: Internet Protocol (TCP/IP) Properties Window	14
Figure 10: Connect Window	15
Figure 11: Device Properties Window	16
Figure 12: VP-88K DIP-switches	16
Figure 13: Status Display Immediately After Turn On	20
Figure 14: Status Display 5 Seconds After Turn On	20
Figure 15: Status Display During Normal Operation	21
Figure 16: Status Display Showing OUTPUT 3, Gain -4.5	21
Figure 17: Configuration Button Numbering	22
Figure 18: Status Display OUTPUT 8 Flashing	23

Figure 19: Status Display Showing OUTPUT 8, Gain -4.5	24
Figure 20: Genlock External Connector and Source Selector Button	24
Figure 21: Control Configuration via RS-232	25
Figure 22: DIP-switch Setting for Machine 2	26
Figure 23: Controlling the VP-88K via Ethernet	27
Figure 24: Java Test Page Success Message	28
Figure 25: Entering the IP Number in the Address Bar	28
Figure 26: The Loading Page	29
Figure 27: First Time Security Warning	29
Figure 28: Main Switching Matrix Page	30
Figure 29: Selecting a Switching Point on the Matrix	31
Figure 30: Switching an Input to an Output	31
Figure 31: AFV Mode Warning	32
Figure 32: AFV Mode Audio Channels Switched	32
Figure 33: Switching Audio in the Offline Mode	33
Figure 34: Exiting Offline Warning	33
Figure 35: Selecting Preset 07	34
Figure 36: Selecting Preset 03	34
Figure 37: Recalling a Preset in Offline Mode	35
Figure 38: Audio Gain Control Page	35
Figure 39: Selecting Audio Input Gain for Channel 2	36
Figure 40: Configuration Page	36

Tables

Table 1: VP-88K RGBHV/Balanced Audio Matrix Switcher Front Panel Features	5
Table 2: RGBHV/Balanced Audio Matrix Switcher Rear Panel Features	7
Table 3: DIP-switch Settings	17
Table 4: Machine Number DIP-switch Settings	17
Table 5: Technical Specifications for the VP-88K	38
Table 6: Communication Parameters	39
Table 7: VP-88K Video Signal Codes	39
Table 8: VP-88K Audio Signal Codes	40
Table 9: VP-88K Audio Input Gain Codes	40
Table 10: VP-88K Audio Output Gain Codes	40
Table 11: VP-88K Hex Codes that Switch Video Channels	41
Table 12: VP-88K Hex Codes that Switch Audio Channels	41
Table 13: VP-88K Hex Codes that Increase/Decrease Audio Input Gain	41
Table 14: Hex Codes that Set the Audio Input Gain	41
Table 15: VP-88K Hex Codes that Increase/Decrease the Audio Output Gain	42
Table 16: VP-88K Hex Codes that Set the Audio Output Gain	42
Table 17: Instruction Codes for Protocol 3000	45
Table 18: Protocol Definitions	51
Table 19: Instruction Codes for Protocol 2000	52

1 Introduction

Welcome to Kramer Electronics! Since 1981, Kramer Electronics has been providing a world of unique, creative, and affordable solutions to the vast range of problems that confront the video, audio, presentation, and broadcasting professional on a daily basis. In recent years, we have redesigned and upgraded most of our line, making the best even better! Our 1,000-plus different models now appear in 11 groups¹ that are clearly defined by function.

Congratulations on purchasing your Kramer **VP-88K RGBHV/Balanced Audio Matrix Switcher**, which is ideal for:

- Professional display systems requiring true 8x8 computer graphics and audio matrix operation
- Multimedia and presentation source, and acceptor selection
- Presentation and production applications

The package includes the following items:

- **VP-88K RGBHV/Balanced Audio Matrix Switcher**
- Power cord
- Windows®-based Kramer control software²
- This user manual³

2 Getting Started

We recommend that you:

- Unpack the equipment carefully and save the original box and packaging materials for possible future shipment
- Review the contents of this user manual
- Use Kramer high performance high resolution cables⁴

2.1 Quick Start

The following quick start chart summarizes the basic steps when connecting a **VP-88K RGBHV/Balanced Audio Matrix Switcher**.

1 GROUP 1: Distribution Amplifiers; GROUP 2: Switchers and Matrix Switchers; GROUP 3: Control Systems; GROUP 4: Format/Standards Converters; GROUP 5: Range Extenders and Repeaters; GROUP 6: Specialty AV Products; GROUP 7: Scan Converters and Sealers; GROUP 8: Cables and Connectors; GROUP 9: Room Connectivity; GROUP 10: Accessories and Rack Adapters; GROUP 11: Sierra Products

2 Download from our Web site at <http://www.kramerelectronics.com>

3 Download the latest user manuals from our Web site at <http://www.kramerelectronics.com>

4 The complete list of Kramer cables is on our Web site at <http://www.kramerelectronics.com>

Step 1: Mount the machine - see section 5

Mount the machine in a rack or stick the 4 rubber feet to the underside

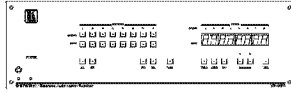

Step 2: Connect the inputs and outputs - see section 6

Connect the video and audio Inputs*

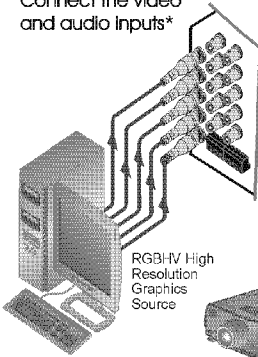

RGBHV High Resolution Graphics Source

Connect the video and audio outputs*

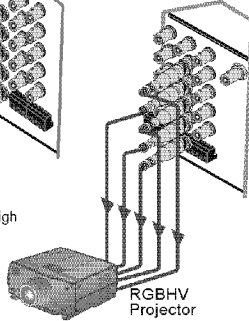

RGBHV Projector

*Audio connections are not shown

Set the DIP-switches

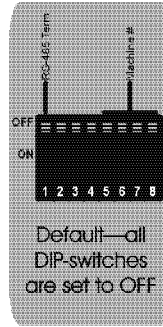

Configure the SYNC source

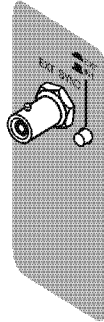

Step 3: Connect the control port - see section 6

Connect an optional RS-232 Control Port, an RS-485 port and/or the ETHERNET Port

Step 4: Turn the power ON

Step 5: Set the machine - see section 7

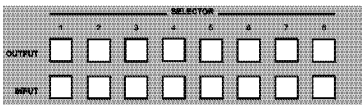

Use the SELECTOR buttons to switch the inputs to the outputs

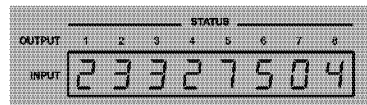

Read the STATUS on the 7-segment display



Connect a selected input to all the outputs



Disconnect an output



Confirm actions



VIDEO - Switching relates to the video signal
AUDIO - Switching relates to the audio signal
AFV - Audio follows video when switching



Store (STO) and recall (RCL) actions

Step 6: Operate the machine

Operate via the front panel buttons, IR remote control, RS-485, RS-232, or ETHERNET

3 Overview

The high performance **VP-88K** *RGBHV/Balanced Audio Matrix Switcher* is designed for high-resolution computer video graphics signals and balanced stereo audio signals. Each machine is a true matrix, routing any input to any or all outputs simultaneously.

In particular, the **VP-88K** *RGBHV/Balanced Audio Matrix Switcher* features:

- Kramer's innovative integrated sync processing; Kr-isp[®] technology that lets you achieve a sharp stable image by restoring the signal waveform, even when the sync level is too low
- Three high bandwidth video channels, Red, Green and Blue (RGB) and two TTL (logic level) channels – Horizontal and Vertical sync
- Channel switching during the vertical interval, offering glitch-free transitions when sources share a common reference sync
- Audio breakaway, for switching audio independently from video
- Preset memory locations for quick access to common configurations
- A TAKE button, which lets you place multiple switches in a queue and then activate them with one touch of the TAKE button
- Mixed video application usage, such as CV, Y/C, and YUV simultaneously
- An Ethernet connection that supports easy dial-up and Internet system remote control (requiring only a dedicated IP address¹ and a modem in the remote location) whether it is a stand-alone PC or a LAN² system

Control the **VP-88K** using the front panel buttons, or remotely via:

- RS-485
- RS-232 serial commands transmitted by a touch screen system, PC, or other serial controller (Protocol 2000 and Protocol 3000)
- Ethernet
- The Kramer **RC-IR3** Infrared Remote Control Transmitter
- An (optional) external remote IR receiver (see [Section 4.1](#))

The **VP-88K** is dependable, rugged, and fits into three vertical spaces (3U) of a standard 19" rack.

To achieve the best performance:

- Connect only good quality connection cables, thus avoiding interference, deterioration in signal quality due to poor matching, and elevated noise- levels
- Avoid interference from neighboring electrical appliances and position your Kramer **VP-88K** away from moisture, excessive sunlight and dust

¹ IP Address is a 32-binary digit number that identifies each sender or receiver (within a network via a particular server or workstation) of data (HTML pages or e-mails) that is sent in packets across the Internet. Every device connected to an IP network must have a unique IP address. This address is used to reference the specific unit

² LAN is Local Area Network

4 Defining the RGBHV/Balanced Audio Matrix Switcher

Figure 1 and Table 1 define the front panel of the **VP-88K**.

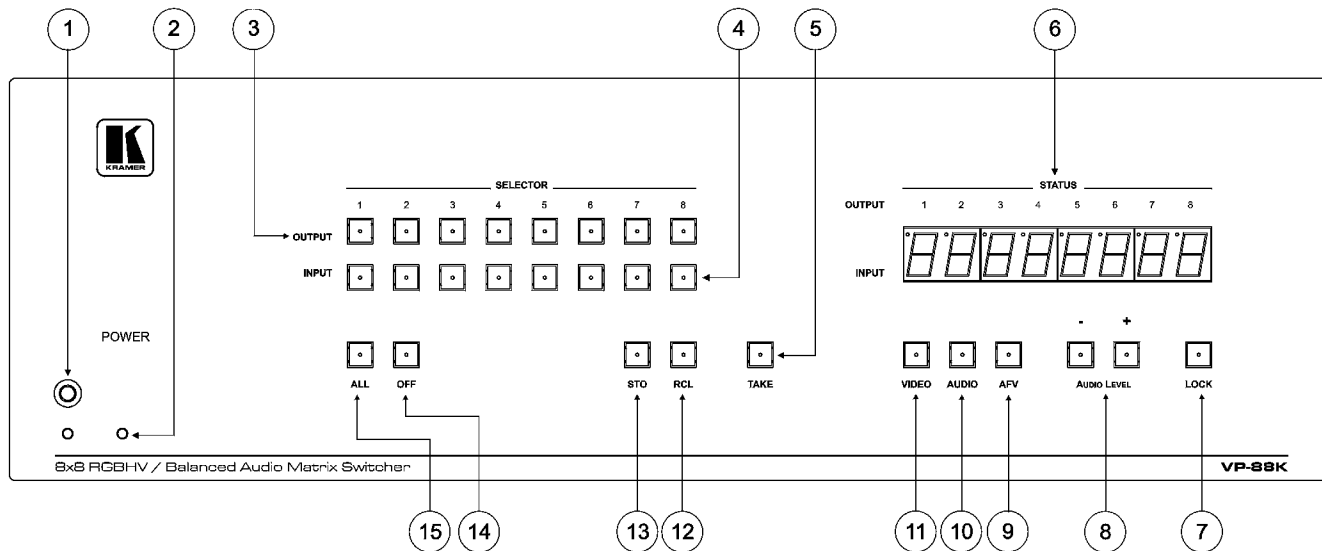

Figure 1: VP-88K RGBHV/Balanced Audio Matrix Switcher Front Panel

Table 1: VP-88K RGBHV/Balanced Audio Matrix Switcher Front Panel Features

#	Feature	Function	
1	IR Receiver LED	Lights yellow LED when receiving signals from the Kramer infra-red remote control transmitter	
2	POWER LED	Lights red when the unit is turned on	
3	OUTPUT SELECTOR buttons	Select the output to which the input is switched	
4	INPUT SELECTOR buttons	Select the input to switch to the output (see Section 7.2)	
5	TAKE button	Press to toggle between the Confirm mode ¹ and the At Once mode (see Section 7.3)	
6	INPUT-OUTPUT STATUS display	Displays the selected input switched to the output (marked above each input)	
7	LOCK button	Locks the front panel buttons	
8	AUDIO LEVEL	+ button	Press to increase the input or output audio signal level
		- button	Press to decrease the input or output audio signal level
9	AFV Button	When pressed ² , actions relate to the video and audio channels. The audio channels follow the video channels	
10	AUDIO Button	When pressed and the button is lit, subsequent actions relate to audio functions	
11	VIDEO Button	When pressed and the button is lit, subsequent actions relate to video functions	
12	RCL Button	Recalls a setup from the non-volatile memory. Press the RCL button followed by an OUTPUT (1-8) or INPUT (9-16) button ³	
13	STO Button	Stores the current settings in non-volatile memory. Press the STO button followed by an OUTPUT (1-8) or INPUT (9-16) button ³	
14	OFF Button	An OFF-OUTPUT combination disconnects that output from the inputs; an OFF-ALL combination disconnects all the outputs	
15	ALL Button	Press ALL followed by an INPUT button to connect that input to all the outputs	

1 When in the Confirm mode, the TAKE button lights

2 The button lights

3 In this case the INPUT or OUTPUT button corresponds to the setup address number

Figure 2 and Table 2 define the rear panel of the **VP-88K**.

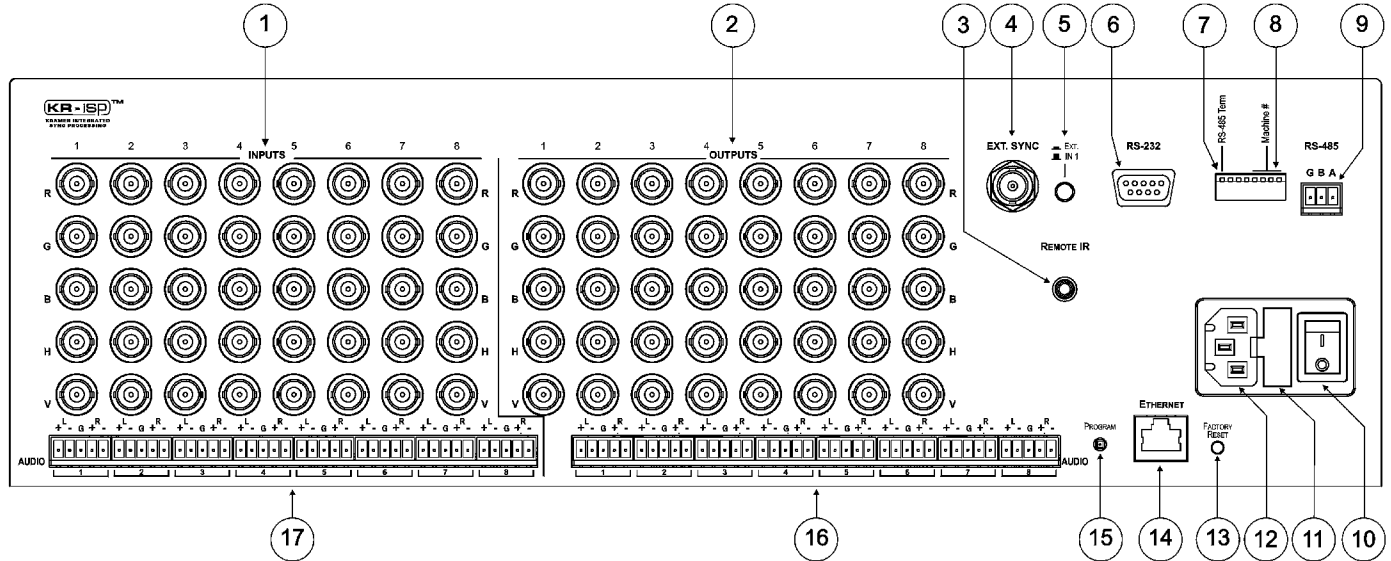

Figure 2: VP-88K RGBHV/Balanced Audio Matrix Switcher Rear View

Table 2: RGBHV/Balanced Audio Matrix Switcher Rear Panel Features

#	Feature	Function														
1	INPUT BNC connectors	Connect to the RGBHV video sources (or composite video, Y/C, YUV, and even SD – SDI signals on different inputs)														
2	OUTPUT BNC connectors	Connect to the RGBHV video acceptors														
3	REMOTE IR 3.5mm mini connector	(Optional, requires a special order cable) Connect to an external IR receiver unit for controlling the machine via an IR remote controller (instead of using the front panel IR receiver) ¹														
4	EXT. SYNC BNC connector	Connects to the external sync source														
5	EXT./IN 1 Button	When pushed in selects an external sync from the external source; when released selects the internal sync (inputted via the video input #1 connectors) (see Section 7.9)														
6	RS-232 9-pin D-sub port	Connects to the PC or the remote controller														
7	RS-485 Term switch	Terminates the RS-485 bus (see Section 6.5)														
8	Machine # DIP-switches	DIP-switches for setup of the unit: 5, 6, 7, and 8 set the machine number; 1 sets the RS-485 bus termination (see Section 6.5)														
9	RS-485 Port	Pin G is for the Ground connection ² ; pins B (-) and A (+) are for RS-485; 12V is connected to the 12V power														
10	Mains power switch	Illuminated switch for tuning the unit ON or OFF														
11	Mains fuse holder	Contains the mains fuse														
12	Mains power socket	Socket for a mains power cable														
13	FACTORY RESET Button	Press and hold while powering up the unit to reset the audio, switching and Ethernet settings to their factory default values: <table border="1" data-bbox="431 742 1003 957"> <tr> <td>IP number</td> <td>192.168.1.39</td> </tr> <tr> <td>Mask</td> <td>255.255.255.0</td> </tr> <tr> <td>Gateway</td> <td>192.168.1.1</td> </tr> <tr> <td>Audio gain for all inputs and outputs</td> <td>0dB</td> </tr> <tr> <td>All switching configuration</td> <td>Erased</td> </tr> <tr> <td>Display</td> <td>1, 2, 3, 4, 5, 6, 7, 8</td> </tr> <tr> <td>Audio mode</td> <td>AFV</td> </tr> </table>	IP number	192.168.1.39	Mask	255.255.255.0	Gateway	192.168.1.1	Audio gain for all inputs and outputs	0dB	All switching configuration	Erased	Display	1, 2, 3, 4, 5, 6, 7, 8	Audio mode	AFV
IP number	192.168.1.39															
Mask	255.255.255.0															
Gateway	192.168.1.1															
Audio gain for all inputs and outputs	0dB															
All switching configuration	Erased															
Display	1, 2, 3, 4, 5, 6, 7, 8															
Audio mode	AFV															
14	ETHERNET RJ-45 Connector	Connects to the PC or other serial controller through the computer network														
15	PROGRAM Button	Push in to enter Program mode to upgrade to the latest Kramer firmware via RS-232; Release to revert to Normal mode (the factory default)														
16	AUDIO OUTPUTS removable terminal blocks	Connect to the balanced stereo audio acceptors														
17	AUDIO INPUTS removable terminal blocks	Connect to the balanced stereo audio sources														

¹ Can be used instead of the front panel (built-in) IR receiver to remotely control the machine (see Section 4.1)

² The ground connection is sometimes connected to the shield of the RS-485 cable. In most applications, the ground is not connected

4.1 Using the IR Transmitter

You can use the **RC-IR3** IR transmitter to control the machine via the built in IR receiver on the front panel or via an external IR receiver¹. The external IR receiver can be located 15m (49ft) away from the machine. This distance can be extended to up to 60 m (197ft) when used with three extension cables². Connect the external IR receiver to the REMOTE IR 3.5mm connector.

5 Installing in a Rack

This section provides instructions for rack mounting the unit.

Before Installing in a Rack

Before installing in a rack, be sure that the environment is within the recommended range:

Operating temperature range	+5° to +45° C (41° to 113° F)
Operating humidity range	10 to 90% RHL, non-condensing
Storage temperature range	-20° to +70° C (-4° to 158° F)
Storage humidity range	5 to 95% RHL, non-condensing



CAUTION!

When installing on a 19" rack, avoid hazards by taking care that:

1. It is located within the recommended environmental conditions, as the operating ambient temperature of a closed or multi unit rack assembly may exceed the room ambient temperature.
2. Once rack mounted, enough air will still flow around the machine.
3. The machine is placed straight in the correct horizontal position.
4. You do not overload the circuit(s). When connecting the machine to the supply circuit, overloading the circuits might have a detrimental effect on overcurrent protection and supply wiring. Refer to the appropriate nameplate ratings for information. For example, for fuse replacement, see the value printed on the product label.
5. The machine is earthed (grounded) in a reliable way and is connected only to an electricity socket with grounding. Pay particular attention to situations where electricity is supplied indirectly (when the power cord is not plugged directly into the socket in the wall), for example, when using an extension cable or a power strip, and that you use only the power cord that is supplied with the machine.

How to Rack Mount

To rack-mount a machine:

1. Attach both ear brackets to the machine. To do so, remove the screws from each side of the machine (5 on each side), and replace those screws through the ear brackets.

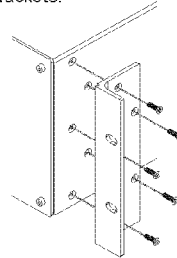

2. Place the ears of the machine against the rack rails, and insert the proper screws (not provided) through each of the four holes in the rack ears.

Note:

- In some models, the front panel may feature built-in rack ears
- Detachable rack ears can be removed for desktop use
- Always mount the machine in the rack before you attach any cables or connect the machine to the power
- If you are using a Kramer rack adapter kit (for a machine that is not 19"), see the Rack Adapters user manual for installation instructions available from: <http://www.kramerelectronics.com>

¹ Kramer P/N: C-A35M/IRR-50

² Kramer P/N: C-A35M/A35F-50

6 Connecting the RGBHV/Balanced Audio Matrix Switcher

To connect the VP-88K RGBHV/Balanced Audio Matrix Switcher¹ (see [Figure 3](#)):

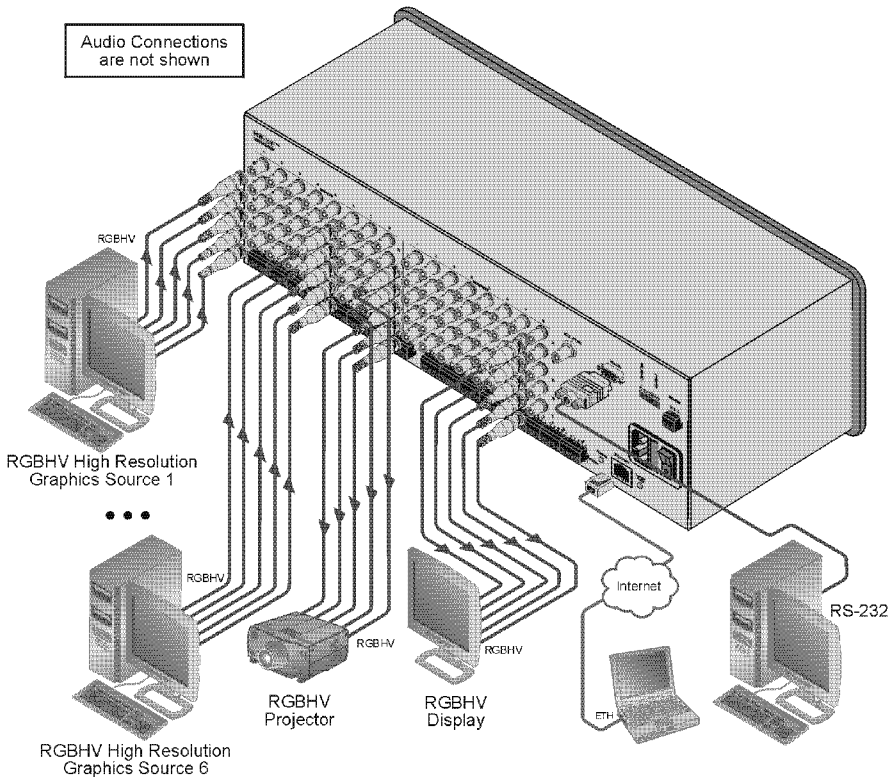

Figure 3: Connecting the VP-88K RGBHV/Balanced Audio Matrix Switcher

1. Connect up to 8 RGBHV video sources² to the BNC INPUT connectors³.
2. Connect up to 8 balanced/unbalanced stereo audio sources to the AUDIO INPUT terminal block connectors.
3. Connect up to 8 RGBHV video acceptors to the BNC OUTPUT connectors³.
4. Connect the corresponding balanced stereo audio acceptors⁴ to the AUDIO OUTPUT terminal blocks.

1 Switch off the power on each device before connecting it to your VP-88K. After connecting your VP-88K, switch on its power and then switch on the power on each device

2 All signal connections using more than one cable to interconnect between the devices should be of equal length

3 5 BNC connectors (RGBHV) per source/acceptor

4 Not illustrated in [Figure 3](#)

5. Set the RS-485 termination and Machine number (see [Section 6.5](#)).
6. If required, connect a PC and/or controller to the:
 - RS-232 port and/or
 - RS-485 port and/or
 - Ethernet connector
7. Connect the power cord¹.

Note that you can use the **VP-88K**²:

- For various video applications (other than RGB), such as, composite video, Y/C (s-Video), YUV (component video), and even SD – SDI signals (Serial Digital Video) on different inputs
- For parallel applications, for example, you can use it simultaneously as a composite video 8x8 matrix and as a Y/C (s-Video) Matrix³
- In mixed applications (such as Y/C and CV simultaneously). To do so, select the parallel output channels for the same format, for example, if the Red and Green Channels are used for Y/C (the Red for “Y” and the Green for “C”) then the output channels should be used similarly (Red for “Y” and Green for “C”)⁴

6.1 Wiring a Balanced/Unbalanced Stereo Audio Input/Output

[Figure 4](#) illustrates how to wire a balanced input/output connection.

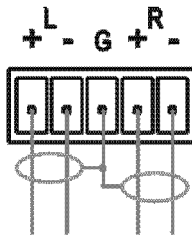

Figure 4: Wiring a Balanced Stereo Audio Input/Output

[Figure 5](#) illustrates how to wire an unbalanced acceptor to the balanced output of the unit.

¹ Not illustrated in [Figure 3](#)

² Including the RGB connectors but not the HV connectors

³ For example, the Red channel is used for composite video and Green and Blue channels are used for s-Video

⁴ In a mixed signal application all the input channels are selected simultaneously. For example, if used for Y/C and CV parallel switching, then when input number 1 is selected, it selects both input number 1 of the Y/C and input number 1 of the CV channel

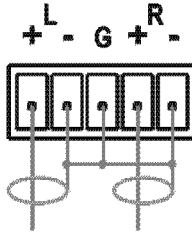

Figure 5: Wiring an Unbalanced Stereo Audio Output

Figure 6 illustrates how to wire an unbalanced source to the balanced input on the VP-88K.

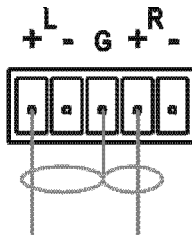

Figure 6: Wiring an Unbalanced Source to a Balanced Input

6.2 Connecting to the VP-88K via RS-232

You can connect to the VP-88K via an RS-232 connection using, for example, a PC. Note that a null-modem adapter/connection is not required.

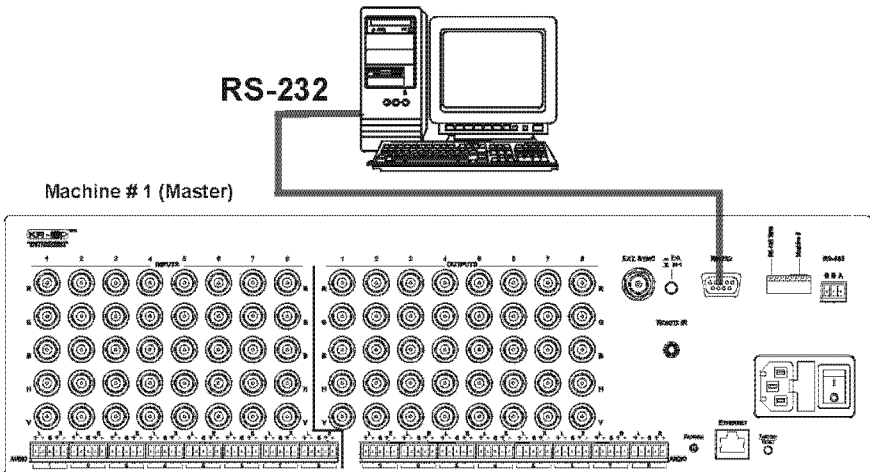

Figure 7: Connecting to the VP-88K via RS-232 using a PC

To connect to the VP-88K via RS-232 as illustrated in the example in Figure 7):

- Connect the RS-232 9-pin D-sub rear panel port on the **VP-88K** unit via a 9-wire straight cable (pin 2 to pin 2, pin 3 to pin 3, pin 5 to pin 5) to the RS-232 9-pin D-sub port on your PC

6.3 Connecting to the VP-88K via RS-485

You can operate the **VP-88K** via the RS-485 port from a distance of up to 1200m (3900ft) using a PC equipped with a card that provides an RS-485 port.

To connect a PC or controller to the RS-485 port on the unit:

1. Wire the RS-485 port on the **VP-88K** to the RS-485 port on the controller as follows:
 - Connect the A (+) pin on the RS-485 port of the PC to the A (+) pin on the RS-485 port on the rear panel of the **VP-88K**
 - Connect the B (-) pin on the RS-485 port of the PC to the B (-) pin on the RS-485 port on the rear panel of the **VP-88K**
 - Connect the G pin on the RS-485 port of the PC to the G pin on the RS-485 port on the rear panel of the **VP-88K**
2. Set the DIP-switches (see [Section 6.5](#)) so that the Machine number on the **VP-88K** is any number between 2 and 16.
3. Terminate the RS-485 line on both the **VP-88K** (set DIP-switch 1 to ON) and on the controller.

6.4 Connecting to the VP-88K via the Ethernet Port

You can connect the **VP-88K** via Ethernet using either of the following methods:

- Direct connection to the PC using a crossover cable (see [Section 6.4.1](#))
- Connection via a network hub, switch, or router, using a straight-through cable (see [Section 6.4.2](#))

Note: The following instructions are valid only if your PC uses a fixed IP address. If your PC receives an IP address from a DHCP server, consult your IT department regarding a suitable IP address.

6.4.1 Connecting Directly via the Ethernet Port

You can connect the Ethernet port of the **VP-88K** to the Ethernet port on your PC via a crossover cable with RJ-45 connectors.

This type of connection is recommended for identification of the factory default IP Address of the VP-88K during the initial configuration

To connect the VP-88K directly to a PC using a crossover cable:

1. Using a crossover cable, connect the **VP-88K** to the PC via the Ethernet port on both units.

2. On the PC, click **Start > Control Panel**.
3. Double-click **Network Connections**.
4. Right-click, and from the menu select **Properties**.
The **Local Area Connection Properties** window appears.
5. Select **Internet Protocol (TCP/IP)** (see [Figure 8](#)).

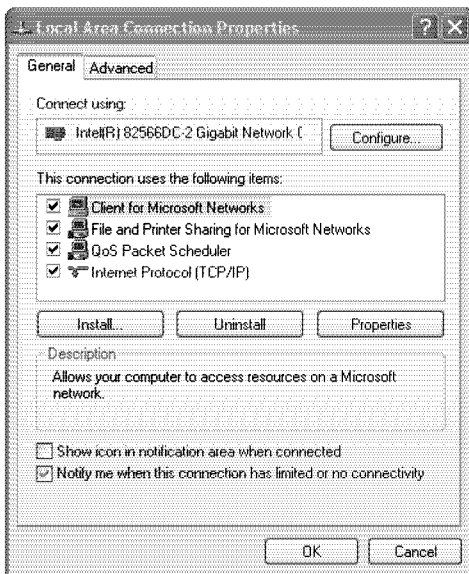

Figure 8: Local Area Connection Properties Window

6. Click the **Properties** button.
7. Select **Use the following IP address**, and fill in the details as shown in [Figure 9](#).

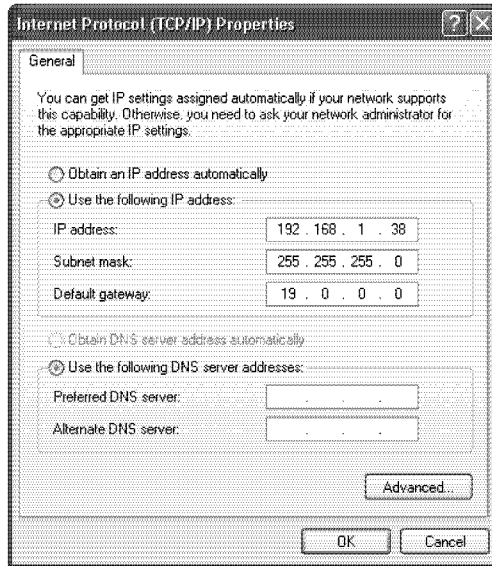

Figure 9: Internet Protocol (TCP/IP) Properties Window

8. Click **OK**.

6.4.2 Connecting via a Network Hub, Switch, or Router

You can connect the Ethernet port of the **VP-88K** to the Ethernet port on a network hub, switch, or router, via a straight-through cable with RJ-45 connectors. The **VP-88K** Ethernet port has to be configured to be compatible with your network (see [Section 6.4.3](#)).

6.4.3 Configuring the Ethernet Port on the VP-88K

To configure the Ethernet port on the **VP-88K**, download the **P3K Ethernet Configuration** software¹ to your PC, extract the files to a folder, and install the software.

To configure the VP-88K Ethernet port:

1. Click **Start > All Programs > Kramer > P3K Wizard**
The **P3K Wizard** window appears.
2. Click **Connect**.
The **Connect** window appears.

¹ Available from <http://www.kramerelectronics.com>

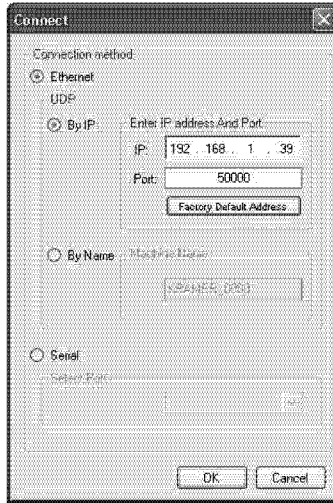

Figure 10: Connect Window

3. Select one of the following methods to connect to the Ethernet port of the **VP-88K**:
 - Ethernet, if you are connected via an Ethernet cable. Enter the IP address¹ or the machine name
The default IP address is 192.168.1.39 and the default name for the unit is KRAMER_XXXX²
 - Serial, if you are connected via a serial port. Select the COM port from the Select Port drop-down list.
4. Click **OK**.
The **Device Properties** window appears.

¹ The default IP address is 192.168.1.39

² The four digits are the last four digits of the machine's serial number.

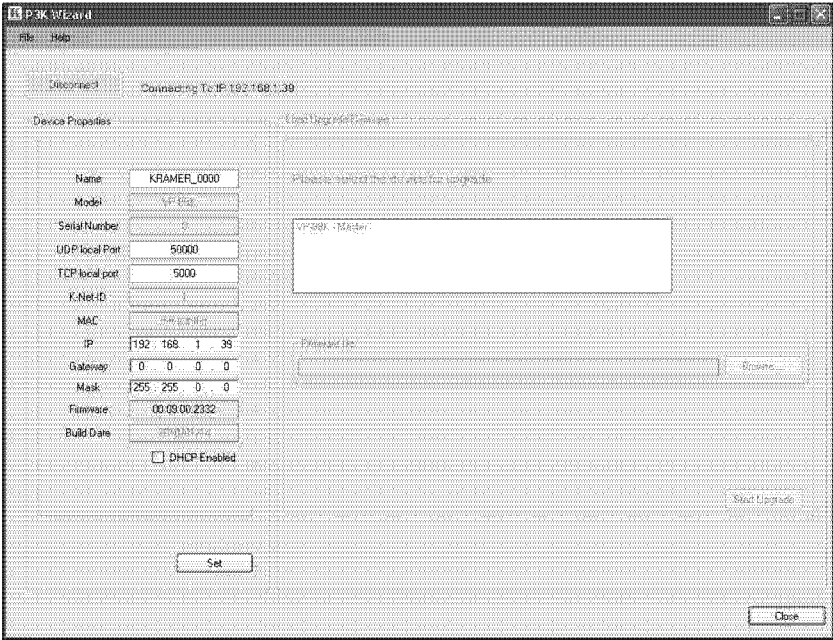

Figure 11: Device Properties Window

5. Make the required changes.
6. Click **Set** to save changes, or click **Close** to exit and not save the changes.

6.5 Setting the VP-88K DIP-switches

This section describes the **VP-88K** DIP-switch settings that configure RS-485 bus termination and **VP-88K** machine number.

Figure 12 illustrates the factory default DIP-switch positions.

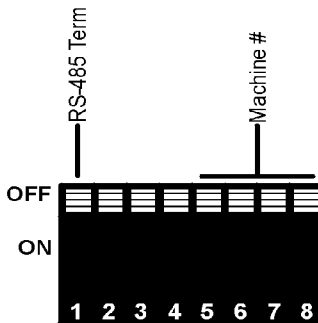

Figure 12: VP-88K DIP-switches

Table 3: DIP-switch Settings

#	DIP-switch Number	Function
1	1	RS-485 Termination
2	2, 3, 4	Not used
3	5, 6, 7, 8	Machine number (see Table 4)

DIP-switch 1 determines the RS-485 bus termination for the **VP-88K**. Moving the switch up turns the termination off (default), moving the switch down turns the termination on.

DIP-switches 2, 3, and 4 are not used.

DIP-switches 5, 6, 7, and 8 determine the machine number of the **VP-88K**. When several **VP-88K** units are connected, the machine number determines the unique identity of the **VP-88K** in the sequence (see Table 4).

- When using a stand-alone **VP-88K** unit, set the machine number to 1 (factory default)
- When connecting more than one **VP-88K**, set the first machine (connected via RS-232) to be machine number 1. The other **VP-88K** units must each be set to a unique machine number between 2 and 16.

Table 4: Machine Number DIP-switch Settings

Machine Number	DIP-switch			
	5	6	7	8
1 (Master, default)	OFF	OFF	OFF	OFF
2 (Slave)	OFF	OFF	OFF	ON
3 (Slave)	OFF	OFF	ON	OFF
4 (Slave)	OFF	OFF	ON	ON
5 (Slave)	OFF	ON	OFF	OFF
6 (Slave)	OFF	ON	OFF	ON
7 (Slave)	OFF	ON	ON	OFF
8 (Slave)	OFF	ON	ON	ON

Machine Number	DIP-switch			
	5	6	7	8
9 (Slave)	ON	OFF	OFF	OFF
10 (Slave)	ON	OFF	OFF	ON
11 (Slave)	ON	OFF	ON	OFF
12 (Slave)	ON	OFF	ON	ON
13 (Slave)	ON	ON	OFF	OFF
14 (Slave)	ON	ON	OFF	ON
15 (Slave)	ON	ON	ON	OFF
16 (Slave)	ON	ON	ON	ON

7 Operating the VP-88K

You can operate the **VP-88K** via the following methods:

- Front panel buttons
- RS-232
- RS-485 serial commands transmitted by a touch screen system, PC, or other serial controller
- Ethernet
- The Kramer **RC-IR3** Infra-Red Remote Control Transmitter

7.1 Displaying the Configuration of the VP-88K

For five seconds after being powered on, the unit's model and software version is displayed (see [Section 7.4.1](#)).

After the first five seconds, the 7-segment display¹ shows which audio² or video³ input is switched to which output (see [Section 7.4.2](#)).

7.2 Switching Outputs to Inputs

To switch a video/audio input to an output:

- Press the desired OUTPUT button, followed by the desired INPUT button.

To connect a video/audio input to all outputs:

- Press the ALL button followed by the INPUT button corresponding to the input that is to be routed to all the outputs

To disconnect a video/audio input from a specific output:

- Press the desired OUTPUT button followed by the OFF button.

To disconnect all outputs:

- Press the ALL button, followed by the OFF button

7.3 Confirming Settings

You can choose to work in the At Once or the Confirm mode. When the **VP-88K** operates in the At Once mode, pressing an output-input combination implements the action immediately. In the Confirm mode, the TAKE button must be pressed to activate the switch.

The At Once Mode

In the At Once mode, execution is immediate and actions require no user confirmation. However, no protection is offered against changing an action in error.

¹ Item 6 in [Table 1](#)

² When the Audio button lights, that is, when the audio breakaway mode is selected

³ When the Video button lights, that is, when the video breakaway mode is selected

The Confirm Mode

In the Confirm mode:

- You can enter several actions and then confirm them by pressing the TAKE button to simultaneously activate the multiple switches
- Every action requires user confirmation which protects against erroneous switching
- Execution is delayed¹ until the user confirms the action

7.3.1 Toggling between At Once and Confirm Modes

To toggle between the At Once and Confirm modes:

1. Press the TAKE button to toggle from the At Once mode² to the Confirm mode³.
Actions now require user confirmation and the TAKE button lights.
2. Press the TAKE button to toggle from the Confirm mode back to the At Once mode.
Actions no longer require user confirmation and the TAKE button no longer lights.

7.3.2 Confirming a Switching Action

To confirm a switching action (in the Confirm mode):

1. Press an output-input combination.
The corresponding input number that is displayed in the STATUS 7-segment display flashes. The TAKE button also flashes.
2. Press the flashing TAKE button to confirm the action.
The corresponding input number that is displayed in the STATUS 7-segment display no longer flashes. The TAKE button lights.

To confirm several actions (in the Confirm mode):

1. Press each OUTPUT-INPUT combination in sequence.
The corresponding input numbers that are displayed in the STATUS 7-segment display flash. The TAKE button also flashes.
2. Press the flashing TAKE button to confirm all the actions.
The corresponding input numbers that are displayed in the STATUS 7-segment display no longer flash. The TAKE button lights.

¹ If the TAKE button is not pressed within one minute, the action is aborted

² The TAKE button does not light

³ The TAKE button lights

7.4 Understanding the 7-Segment Status Display Information

The VP-88K has three display modes:

- Immediately after the power is turned on (see [Section 7.4.1](#))
- During normal operation (see [Section 7.4.2](#))
- During Audio Gain Level Setting (see [Section 7.4.3](#))

7.4.1 Status Display Immediately After Power is Turned On

Immediately after the unit is turned on, the status display shows:

1. The firmware version (major, minor, and revision) for the first five seconds (see [Figure 13](#))

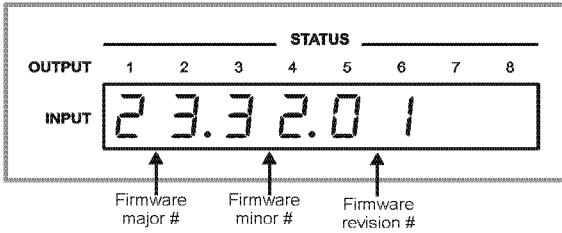

Figure 13: Status Display Immediately After Turn On

2. The firmware build number and machine number for the following five seconds (see [Figure 14](#)).

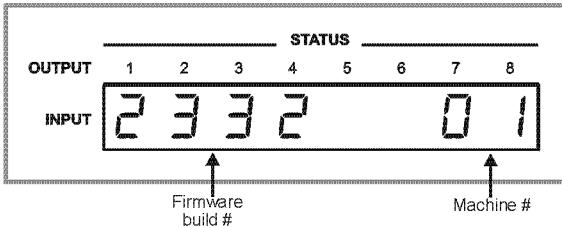

Figure 14: Status Display 5 Seconds After Turn On

7.4.2 Status Display During Normal Operation

During normal operation, the STATUS display shows which inputs are switched to which outputs (an example is shown in [Figure 15](#)).

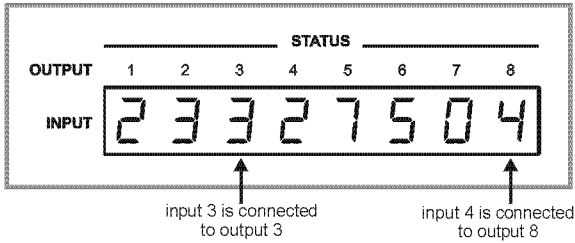

Figure 15: Status Display During Normal Operation

In the VIDEO mode, the display shows the video signal configuration. In the AUDIO mode, the display shows the audio signal configuration. In the AFV mode (see Section 7.5.1), the display shows both signal configurations.

7.4.3 Status Display During Audio Gain Level Setting

During audio gain level setting, the Status display indicates:

- Whether an INPUT or OUTPUT is selected (in this example, OUTPUT)
- Which channel number is selected (in this example, 3)
- The current gain setting in 0.5dB increments (in this example, -4.5). The 0.5dB is indicated by the period following the 4.

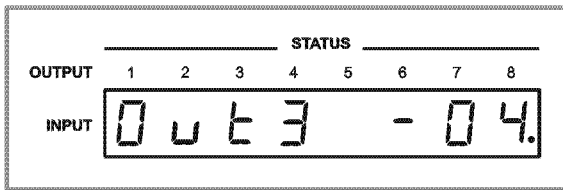

Figure 16: Status Display Showing OUTPUT 3, Gain -4.5

To set the audio gain levels, see Section 7.7.

7.5 Choosing the Audio-Follow-Video or Breakaway Option

You can configure stereo audio signal switching in one of two ways:

- Audio-follow-video (AFV), in which all operations relate to both the video and the audio channels (see Section 7.5.1)
- Breakaway, in which video and audio channels switch independently (see Section 7.5.2)

7.5.1 Setting the Audio-Follow-Video Option

To set the Audio-follow-video (AFV) option, press the AFV button. One of the following occurs:

- If the AUDIO and VIDEO configurations are the same, then the AFV button lights. The audio follows the video

- If the AUDIO differs from the VIDEO, then the TAKE and the AUDIO buttons flash. Also, the audio outputs of the STATUS 7-segment display which change, flash¹. Press the TAKE button to confirm the modification. The audio follows the video

7.5.2 Setting the Breakaway Option

To set the Breakaway option:

- Press either the AUDIO (for audio control only) or the VIDEO (for video control only) button. One of the following occurs:
 - If the AUDIO button lights, switching operations relate to Audio
 - If the VIDEO button lights, switching operations relate to Video

The STATUS window displays audio or video settings according to your selection.

7.6 Storing/Recalling Input-Output Configurations

You can store and recall up to 16 input-output configurations (or setups) in non-volatile memory, using the OUTPUT (1-8) and OUTPUT (9-16) SELECTOR buttons (see [Figure 17](#)).

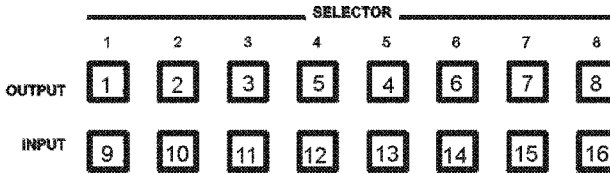

Figure 17: Configuration Button Numbering

7.6.1 Storing an Input-Output Configuration

To store the current status in memory:

1. Press the STO button.
The STO button flashes.
2. Press one of the INPUT/OUTPUT SELECTOR buttons from 1 to 8. This is the setup number in which the current status is stored.
The memory stores the data at that reference.

7.6.2 Recalling an Input-Output Configuration

To recall an input-output configuration, do the following:

1. Press the RCL button.
The RCL button flashes.

¹ This warns that you are about to modify the audio configuration for AFV operation

2. Press the appropriate INPUT/OUTPUT SELECTOR button (the INPUT SELECTOR button number corresponding to the setup number).
The memory recalls the stored data from that reference.

7.6.3 Deleting an Input-Output Configuration

To delete an input-output configuration:

1. Press the STO and RCL buttons simultaneously.
The STO and RCL buttons flash.
2. Press the appropriate INPUT SELECTOR button.
The specific input-output configuration is erased from the memory, leaving it empty and available¹.

7.7 The Audio Input/Output Gain Control

The audio gain control is configured when the machine is in AUDIO or AFV mode.

The default audio gain level for all inputs and outputs is 0dB. Each input or output can be set independently.

To set the gain level of an input or output:

1. To enter the audio gain setting mode, do either of the following:
 - Press either of the Audio Level buttons and press the required INPUT or OUTPUT SELECTOR button
 - Press the required INPUT or OUTPUT SELECTOR button.
If an OUTPUT was pressed, the display indicates which OUTPUT is selected by flashing the selected number. In this example, OUTPUT 8 is selected (see [Figure 18](#)).

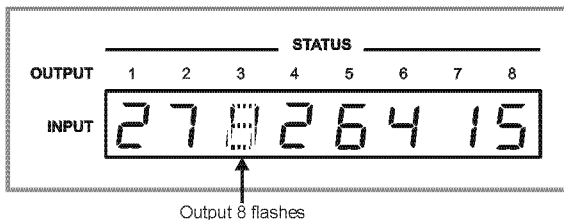

Figure 18: Status Display OUTPUT 8 Flashing

2. Press either the plus (+) button to increase, or the minus (-) button to decrease the current gain level setting.
The display changes to indicate (see [Figure 19](#)):
 - whether an INPUT or OUTPUT is selected (in this example, OUTPUT)
 - which channel number is selected (in this example, 8)
 - the current gain setting (in this example, -4.5)

¹ Storing a new configuration over a previous configuration (without deleting it first) replaces the previous configuration

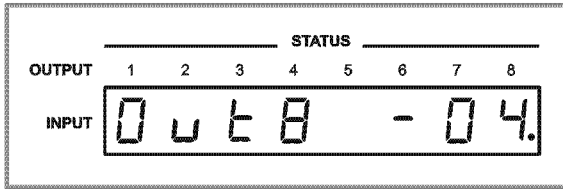

Figure 19: Status Display Showing OUTPUT 8, Gain -4.5

3. Press either the (+) button to increase or the minus (-) button to increase or decrease respectively the gain level setting.
The display changes accordingly.
4. Press either the Audio or Video button to exit the gain level setting mode. If no button is pressed for 10 seconds, the **VP-88K** automatically exits the gain level setting mode and the display reverts to normal operation.

The factory default audio gain is set to 0dB. An audio gain value of 0dB indicates that the output signal value is identical to the input signal value. When increasing/decreasing the audio gain, the output signal level is higher/lower than the input signal level.

Gain level values are relative since the audio input signal can also be adjusted independently of the output level adjustment.

7.8 Resetting the Unit

To reset the unit:

- Press and hold the Reset button on the rear panel while powering on the device.

The device resets and a Status display self-test is performed (see [Section 7.4.1](#))

7.9 Selecting the Genlock Source

The button on the rear panel marked EXT/IN (see item 5 on [Figure 2](#)) selects the Genlock source. When pressed in, the Genlock signal is taken from the EXT SYNC connector situated alongside the Genlock source button (see [Figure 20](#)). When the switch is released (in the out position), the Genlock is taken from the video input 1 vertical signal.

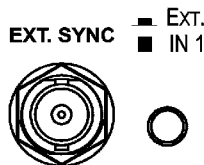

Figure 20: Genlock External Connector and Source Selector Button

8 Controlling the VP-88K

The **VP-88K** can be controlled via any of the following:

- RS-232 (see [Section 8.1](#))
- RS-485 (see [Section 8.2](#))
- Ethernet (see [Section 8.3](#))

8.1 Controlling the VP-88K via RS-232

To control up to sixteen VP-88K units from a PC or serial controller via RS-232, as illustrated in [Figure 21](#):

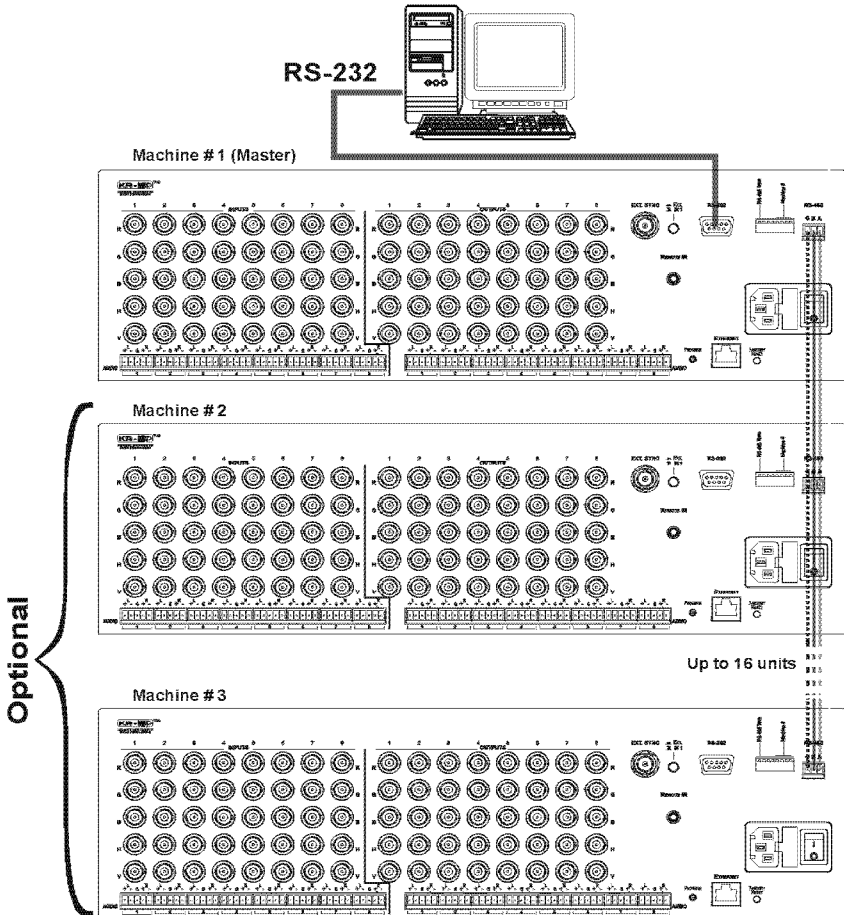

Figure 21: Control Configuration via RS-232

1. Connect the video sources and acceptors, the appropriate audio sources and acceptors, and the power cord to each **VP-88K**.
2. Connect the RS-232 port on the first **VP-88K** to the PC (see [Section 6.2](#)).
3. Set the Machine # to 1 of the unit connected to the PC.
4. Set Machine 1 RS-485 termination to On (see [Section 6.5](#)).
5. Set the Machine # on all **VP-88K** units other than Machine 1 to a unique number between 2 and 16 (see [Section 6.5](#)).
6. Set the termination on all **VP-88K** units other than Machine 1 to Off.
7. Interconnect the RS-485 bus on all **VP-88K** units:
 - From the RS-485 connector on the first **VP-88K** unit, to the RS-485 port on the second **VP-88K** unit, and so on. Up to sixteen **VP-88K** units can be connected.

8.2 Controlling the VP-88K via RS-485

To control up to fifteen **VP-88K** units via an RS-485 controller or a PC equipped with an RS-485 interface¹:

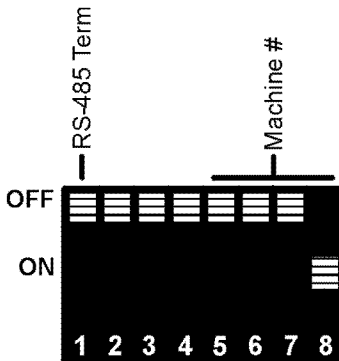

Figure 22: DIP-switch Setting for Machine 2

1. Connect up to 15 **VP-88K** devices to the controller via RS-485 (see [Section 6.3](#)).
2. Connect the video sources and acceptors, the appropriate audio sources and acceptors, and the power cord to each **VP-88K** unit.
3. Set the Machine number on the first **VP-88K** to be Machine 2 (see [Section 6.5](#)).
4. Terminate the RS-485 line on both the Controller/PC and on the last **VP-88K** (set DIP-switch 1 to ON).

¹ Switch OFF the power on each device before connecting it to your VP-88K. After connecting your VP-88K, switch on its power and then switch on the power on each device

5. Set the Machine number on all **VP-88K** units other than Machine 2 to a unique number between 3 and 16 (see [Section 6.5](#))¹. [Figure 22](#) shows the DIP-switch setting for Machine 2.

8.3 Controlling the VP-88K via Ethernet

Before trying to control the **VP-88K** via Ethernet, the unit must first be configured according to the instructions in [Section 6.4](#).

To control the VP-88K via Ethernet:

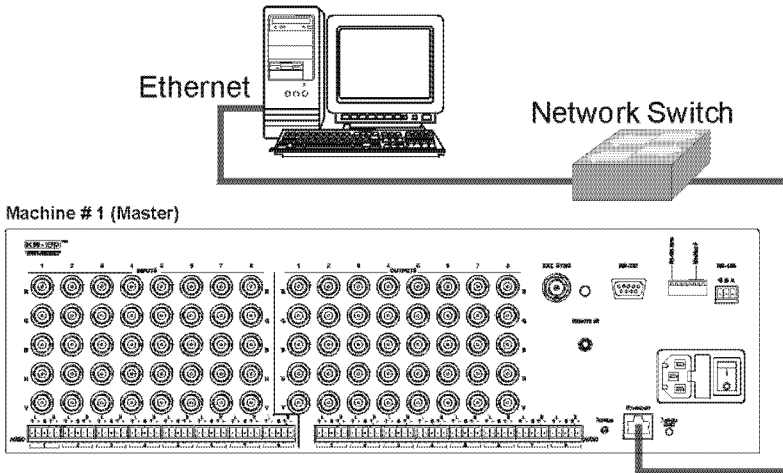

Figure 23: Controlling the VP-88K via Ethernet

1. Connect the Ethernet port on Machine number 1 to the LAN port of your PC either:
 - Via a network switch (as shown in [Figure 23](#))
 - Using a straight-through cable directly using a crossover cable
2. Set the Machine number on the **VP-88K** to be Machine 1 (see [Section 6.5](#)).

¹ Set the first unit to Machine number 2, the second unit to Machine number 3, and so on up to 16

9 Connecting to the VP-88K via your Browser

You can remotely operate the **VP-88K** using a Web browser via the Ethernet connection (see [Section 9.1](#)). To be able to do so, you must use a supported Web browser; Microsoft (V6.0 and higher), Chrome, Firefox (V3.0 and higher).

To check that Java is installed and running, browse to:
<http://www.java.com/en/download/help/testvm.xml>

This page runs a test and displays a Java success (see [Figure 24](#)) or failure message.



Figure 24: Java Test Page Success Message

If you do not see the success message, follow the instructions on the page to:

- Load and enable Java
- Enable Javascript in your browser

9.1 Connecting to the VP-88K User Manual via your Browser

Make sure that your PC is connected via a network to the **VP-88K** and do the following:

1. Open your Internet browser.
2. Enter the unit's IP number (for the default IP address, see [Figure 25](#)) or name in the Address bar of your browser.
If you are using DHCP, you have to enter the name.



Figure 25: Entering the IP Number in the Address Bar

The Loading page appears.

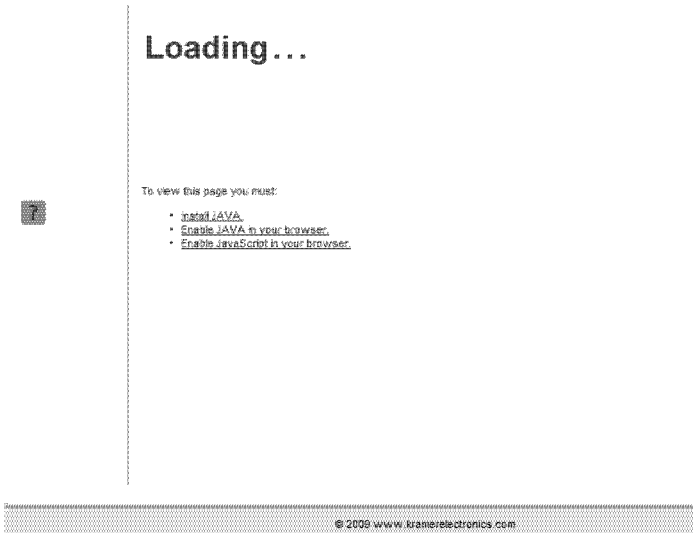

Figure 26: The Loading Page

The first time that you run the Kramer applet a security warning appears.



Figure 27: First Time Security Warning

3. Click **Run**.

The main switching control page is displayed which shows a graphical representation of the front panel (see [Figure 28](#)).

There are three remote operation Web pages:

- Main switching matrix (see [Section 9.2](#))
- Audio gain control (see [Section 9.3](#))

- Configuration (see [Section 9.4](#))

Select a page by clicking on the relevant link on the left hand side of the window.

9.2 The Main Switching Matrix Page

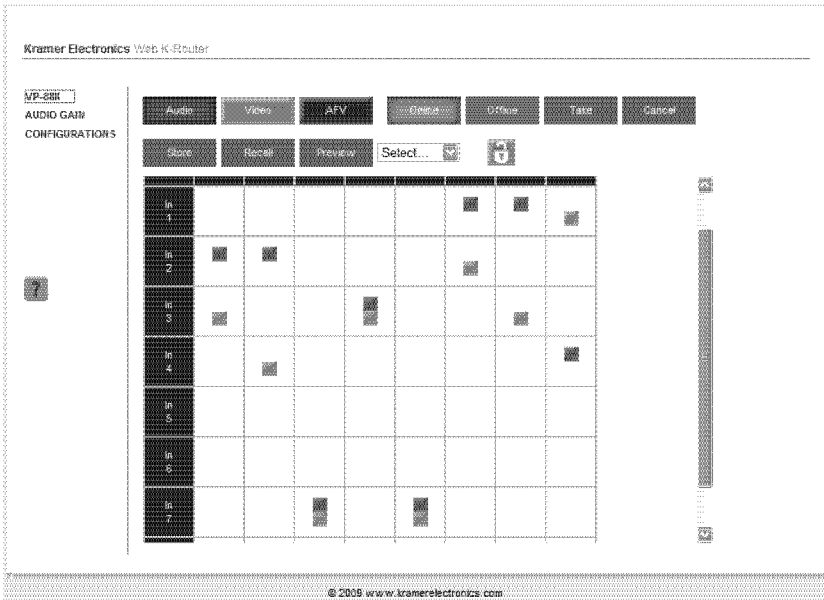

Figure 28: Main Switching Matrix Page

The main switching matrix page allows you to:

- Switch any audio/video input to any/all outputs independently (see [Section 9.2.1](#))
- Set the audio to operate in AFV (Audio Follow Video) mode (see [Section 9.2.2](#))
- Operate the unit in the Offline mode (see [Section 9.2.3](#))
- Use presets to store and recall switching configurations (see [Section 9.2.4](#))
- Lock or unlock the unit's front panel buttons (see [Section 9.2.5](#))

9.2.1 Switching an Input to an Output

To switch an input to an output, for example, video input 1 to video output 4:

1. Click the blue **Video** button.
The button outline becomes dark. Actions now relate to video channels.
2. Click the required point within the switching matrix grid (In 1, Out 4).

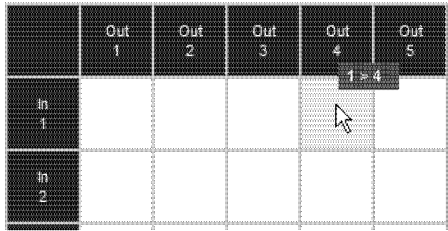



Figure 29: Selecting a Switching Point on the Matrix

A blue video icon  appears indicating that the video channel is switched to In 1 and Out 4.

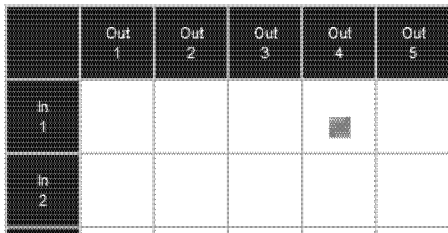

Figure 30: Switching an Input to an Output

3. Repeat the above steps for each video and audio (clicking the purple **Audio** button) channel that you want to switch.

9.2.2 Setting the AFV Mode

Audio channel In 1 is currently switched to Out 4.

To set the AFV mode:

1. Click the **AFV** button.
The following warning appears.

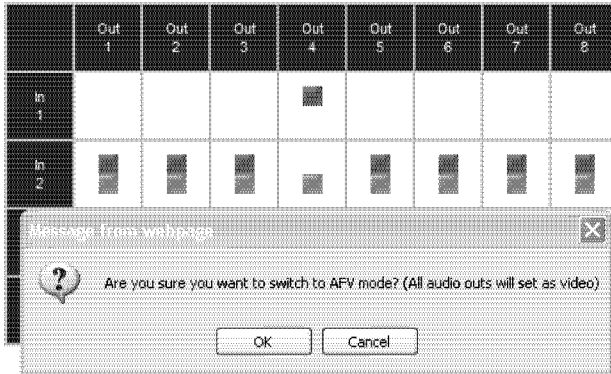

Figure 31: AFV Mode Warning

2. Click **OK**.
 The **AFV** button outline becomes dark.
 All audio channels are switched according to the corresponding video channels. In this example, audio channel In 2 is now switched to Out 4.

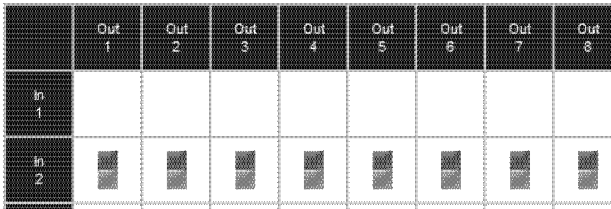

Figure 32: AFV Mode Audio Channels Switched

All configuration changes now switch audio and video simultaneously.

9.2.3 Operating in the Offline Mode

By default, the unit operates in the At-Once mode, meaning that any switching changes take effect immediately. In the Offline mode, changes only take effect when you press the **Take** button.

To operate in the Offline mode:

1. Click the red **Offline** button.
 The button outline becomes dark.
2. Click the required point in the switching matrix grid (In 1, Out 5).
 The audio/video indicator icon outline (in this example, audio) appears, and the **Take** and **Cancel** buttons change from gray to dark blue.

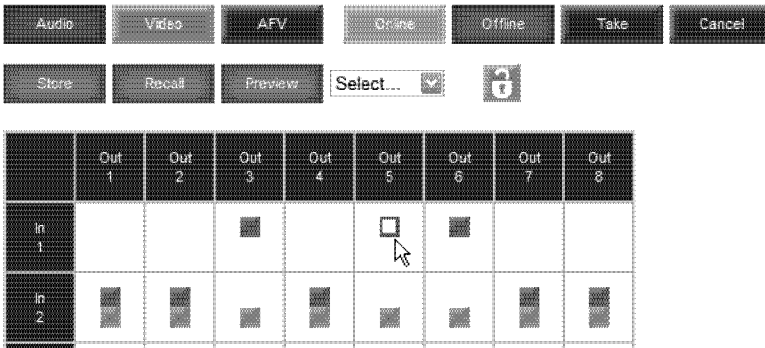

Figure 33: Switching Audio in the Offline Mode

3. If required, repeat Step 2 for several audio/video channels.
4. Click either **Take** to accept the change or **Cancel**.
5. Click the **Online** button to exit the Offline mode.
If you have made any changes since clicking the **Take** button, the exiting Offline warning appears.



Figure 34: Exiting Offline Warning

9.2.4 Storing and Recalling Setups

You can store switching configurations in presets and recall them at any time.

To store a switching configuration:

1. From the Preset drop-down list, select a preset (in this example, Preset 07). Presets that contain a configuration are displayed with a blue background; presets with no configuration have a white background.
When you select a preset, the **Store** button changes from gray to dark blue.

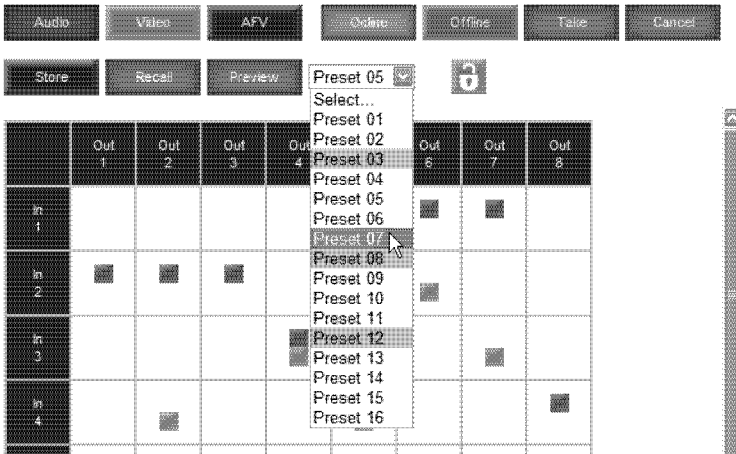

Figure 35: Selecting Preset 07

2. Click **Store**.
A confirmation message appears.
3. Click **OK**.
The configuration is stored in Preset 07.

To recall a setup:

1. From the Preset drop-down list, select a preset (in this example, Preset 03). Presets that contain a configuration are displayed with a blue background; presets with no configuration have a white background. When you select a preset that contains a configuration, the **Recall** button changes from gray to dark blue.

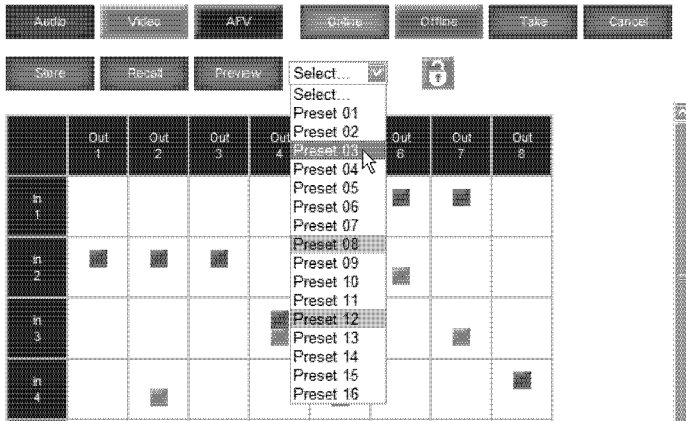

Figure 36: Selecting Preset 03

2. Click **Recall**.
A confirmation message appears.
3. Click **OK**.
The configuration from Preset 03 is loaded.

Note: You can also recall a preset in the Offline mode (see [Figure 38](#)) and make it active when you press the **Take** button (see [Section 9.2.3](#)).

	Out 1	Out 2	Out 3	Out 4	Out 5	Out 6	Out 7	Out 8
In 1	<input type="checkbox"/>	<input type="checkbox"/>	<input type="checkbox"/>	<input type="checkbox"/>	<input type="checkbox"/>	<input type="checkbox"/>	<input type="checkbox"/>	<input type="checkbox"/>
In 2		<input type="checkbox"/>		<input type="checkbox"/>			<input type="checkbox"/>	
In 3					<input type="checkbox"/>			<input type="checkbox"/>
In 4								

Figure 37: Recalling a Preset in Offline Mode

9.2.5 Locking the Front Panel Buttons

You can lock the front panel buttons to prevent tampering.

To lock the front panel buttons:

- Click the padlock icon 

Note: Locking the front panel buttons does not disable remote operation of the unit via Ethernet, RS-232 or RS-485.

9.3 Audio Input Gain Control Page

The Audio Gain page lets you set the gain for each of the input channels independently.

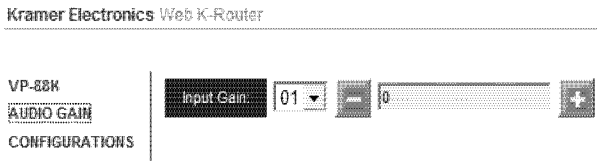

Figure 38: Audio Gain Control Page

To change the audio gain (in this example, input gain for channel 2):

1. From the Input Gain drop-down list, click 02.

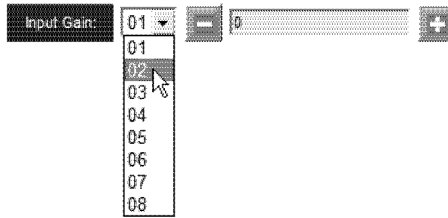

Figure 39: Selecting Audio Input Gain for Channel 2

2. Click the – or + button to decrease or increase the gain. Hold the – or + button down to cycle through the values.

Note: Each click increments/decrements the value by 0.5. To change the gain by a whole number, you must click the +/- button twice.

9.4 The Configuration Page

The Configuration page lets you edit the IP-related settings and only view the others. Editable fields have a white background.

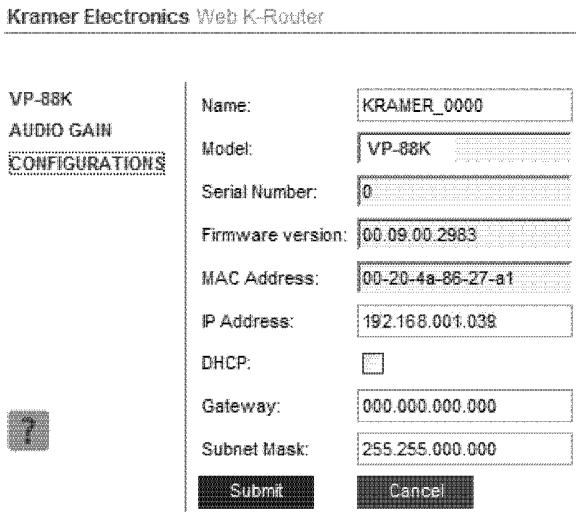

Figure 40: Configuration Page

The following IP-related settings can be edited:

- Machine name
- Fixed IP Address/DHCP

- Gateway
- Subnet Mask

The following fields can be viewed:

- Model
- Serial Number
- Firmware Version
- MAC Address

To edit the IP-related settings:

1. Edit the required field.
2. Click **Submit**.
The Network Settings confirmation message appears.
3. Click **OK**.
A message appears showing that the settings have been successfully changed.
4. If the IP address was changed or you selected DHCP, reload the Web page using the new name or IP address.

10 Flash Memory Upgrade

For instructions on upgrading the firmware, see the *Updating the Firmware Using the P3K Software* document.

The latest version of firmware and installation instructions can be downloaded from the Kramer Web site at www.kramerelectronics.com.

11 Technical Specifications

Table 5 provides the technical specifications for the **VP-88K**.

Table 5: Technical Specifications¹ for the VP-88K

INPUTS:	8x3 video (RGB): 0.7 Vpp/75Ω on BNC connectors; 1 Sync ² Genlock with sync select switch 1Vpp on a BNC connector 8x2 Hs & Vs, TTL level/510Ω on BNC connector 8 balanced stereo audio, 2.2V @10kΩ on detachable terminal blocks	
OUTPUTS:	8x3 video (RGB): 0.7 Vpp/75Ω on BNC connectors 8x2 Hs & Vs, TTL level/75Ω on BNC connectors 8 balanced stereo audio, 2.2V @150Ω on detachable terminal blocks	
MAX. OUTPUT LEVEL:	VIDEO: 2.4Vpp (RGB)	AUDIO: 15Vpp @150Ω
BANDWIDTH (-3dB):	VIDEO: 350MHz, Fully Loaded	AUDIO: 22kHz @-3dB
S/N RATIO:	VIDEO: 74dB	AUDIO: 81dB @1kHz
CROSSTALK (all hostile):	VIDEO: -47dB @ 5MHz	AUDIO: <-57dB @ 20kHz
DIFF. GAIN	0.05	
DIFF. PHASE	0.05	
CONTROLS:	Manual, RS-232, RS-485 or ETHERNET	
AUDIO THD:	0.089% (1V, 1kHz)	
POWER SOURCE:	100 - 240VAC, 50/60Hz, 18VA	
DIMENSIONS:	48.26cm x 17.78cm x 3U (19" x 7" x 3U) W, D, H	
WEIGHT:	5.5kg (12.2lbs) approx.	
ACCESSORIES:	Power cord, Windows®-based Kramer control software	
OPTIONS:	External remote IR receiver cable ³	

¹ Specifications are subject to change without notice

² The sync input cannot accept video signal level

³ P/N: C-A35M/IRR-50

12 Communication Parameters

Table 6 lists the communication parameters as used in Kramer Electronics products.

Table 6: Communication Parameters

RS-232			
Protocol 2000		Protocol 3000 (Default)	
Baud Rate:	9600	Baud Rate:	115,200
Data Bits:	8	Data Bits:	8
Stop Bits:	1	Stop Bits:	1
Parity:	None	Parity:	None
Command Format:	HEX	Command Format:	ASCII
Example (Output 1 to Input 1):	0x01, 0x81, 0x81, 0x81	Example (Output 1 to Input 1):	#AV 1>1<CR>
Switching Protocol			
P2000 -> P3000		P3000 -> P2000	
Command:	0x38, 0x80, 0x83, 0x81	Command:	#P2000<CR>
Front Panel:	Press and hold Output 1 and Output 3 simultaneously	Front Panel:	Press and hold Output 1 and Output 2 simultaneously
Ethernet			
Default Settings		Reset Settings	
IP Address: 192.168.1.39 Subnet mask: 255.255.255.0 Gateway: 192.168.1.1		Power cycle the unit while holding in the Factory Reset button, located on the rear panel of the unit.	
TCP Port #: 5000			
UDP Port #: 50000			

13 Tables of ASCII Codes for Serial Communication (Protocol 3000)

Table 7 and Table 8 list the ASCII codes that switch an input to an output for a single VP-88K machine. For more detailed information, see Section 15.2.

Table 7: VP-88K Video Signal Codes

	OUT 1	OUT 2	OUT 3	OUT 4	OUT 5	OUT 6	OUT 7	OUT 8
IN 1	#V 1>1 CR	#V 1>2 CR	#V 1>3 CR	#V 1>4 CR	#V 1>5 CR	#V 1>6 CR	#V 1>7 CR	#V 1>8 CR
IN 2	#V 2>1 CR	#V 2>2 CR	#V 2>3 CR	#V 2>4 CR	#V 2>5 CR	#V 2>6 CR	#V 2>7 CR	#V 2>8 CR
IN 3	#V 3>1 CR	#V 3>2 CR	#V 3>3 CR	#V 3>4 CR	#V 3>5 CR	#V 3>6 CR	#V 3>7 CR	#V 3>8 CR
IN 4	#V 4>1 CR	#V 4>2 CR	#V 4>3 CR	#V 4>4 CR	#V 4>5 CR	#V 4>6 CR	#V 4>7 CR	#V 4>8 CR
IN 5	#V 5>1 CR	#V 5>2 CR	#V 5>3 CR	#V 5>4 CR	#V 5>5 CR	#V 5>6 CR	#V 5>7 CR	#V 5>8 CR
IN 6	#V 6>1 CR	#V 6>2 CR	#V 6>3 CR	#V 6>4 CR	#V 6>5 CR	#V 6>6 CR	#V 6>7 CR	#V 6>8 CR
IN 7	#V 7>1 CR	#V 7>2 CR	#V 7>3 CR	#V 7>4 CR	#V 7>5 CR	#V 7>6 CR	#V 7>7 CR	#V 7>8 CR
IN 8	#V 8>1 CR	#V 8>2 CR	#V 8>3 CR	#V 8>4 CR	#V 8>5 CR	#V 8>6 CR	#V 8>7 CR	#V 8>8 CR

Table 8: VP-88K Audio Signal Codes

	OUT 1	OUT 2	OUT 3	OUT 4	OUT 5	OUT 6	OUT 7	OUT 8
IN 1	#A 1>1 CR	#A 1>2 CR	#A 1>3 CR	#A 1>4 CR	#A 1>5 CR	#A 1>6 CR	#A 1>7 CR	#A 1>8 CR
IN 2	#A 2>1 CR	#A 2>2 CR	#A 2>3 CR	#A 2>4 CR	#A 2>5 CR	#A 2>6 CR	#A 2>7 CR	#A 2>8 CR
IN 3	#A 3>1 CR	#A 3>2 CR	#A 3>3 CR	#A 3>4 CR	#A 3>5 CR	#A 3>6 CR	#A 3>7 CR	#A 3>8 CR
IN 4	#A 4>1 CR	#A 4>2 CR	#A 4>3 CR	#A 4>4 CR	#A 4>5 CR	#A 4>6 CR	#A 4>7 CR	#A 4>8 CR
IN 5	#A 5>1 CR	#A 5>2 CR	#A 5>3 CR	#A 5>4 CR	#A 5>5 CR	#A 5>6 CR	#A 5>7 CR	#A 5>8 CR
IN 6	#A 6>1 CR	#A 6>2 CR	#A 6>3 CR	#A 6>4 CR	#A 6>5 CR	#A 6>6 CR	#A 6>7 CR	#A 6>8 CR
IN 7	#A 7>1 CR	#A 7>2 CR	#A 7>3 CR	#A 7>4 CR	#A 7>5 CR	#A 7>6 CR	#A 7>7 CR	#A 7>8 CR
IN 8	#A 8>1 CR	#A 8>2 CR	#A 8>3 CR	#A 8>4 CR	#A 8>5 CR	#A 8>6 CR	#A 8>7 CR	#A 8>8 CR

Table 9 lists the codes that set the audio input gain. For more detailed information, see Section 15.2.

Table 9: VP-88K Audio Input Gain Codes

INPUT 1		INPUT 5		INPUT X*	Level [Rel]
#AUD-LVL 1,1, -100 CR	...	#AUD-LVL 1,5, -100 CR	...	#AUD-LVL 1,X, -100 CR	-100dB Mute
:		:		:	
#AUD-LVL 1,1, -50 CR	...	#AUD-LVL 1,5, -50 CR	...	#AUD-LVL 1,X, -50 CR	-50dB
:		:		:	
#AUD-LVL 1,1, 0 CR	...	#AUD-LVL 1,5, 0 CR	...	#AUD-LVL 1,X, 0 CR	0dB
:		:		:	
#AUD-LVL 1,1, 14 CR	...	#AUD-LVL 1,5, 14 CR	...	#AUD-LVL 1,X, 14 CR	+14dB (Max)

* Where X is the input number from 1 - 8. For example, for channel 7 and relative level -50dB, #AUD-LVL 1,7, -50 CR

Table 10 lists the codes that set the audio output gain. For more detailed information, see Section 15.2.

Table 10: VP-88K Audio Output Gain Codes

OUTPUT 1		OUTPUT 5		OUTPUT X*	Level [Rel]
#AUD-LVL 2,1, -100 CR	...	#AUD-LVL 2,5, -100 CR	...	#AUD-LVL 2,X, -100 CR	-100dB Mute
:		:		:	
#AUD-LVL 2,1, -50 CR	...	#AUD-LVL 2,5, -50 CR	...	#AUD-LVL 2,X, -50 CR	-50dB
:		:		:	
#AUD-LVL 2,1, 0 CR	...	#AUD-LVL 2,5, 0 CR	...	#AUD-LVL 2,X, 0 CR	0dB
:		:		:	
#AUD-LVL 2,1, 13 CR	...	#AUD-LVL 2,5, 13 CR	...	#AUD-LVL 2,X, 13 CR	+13dB (Max)

* Where X is the output number from 1 - 8. For example, for channel 7 and relative level -50dB, #AUD-LVL 2,7, -50 CR

14 Tables of Hex Codes for Serial Communication (Protocol 2000)

The hex codes listed in this section are used to set video channels for a single machine (set as Machine 1) connected via either RS-232 or Ethernet. Similar hex

codes are used when the **VP-88K** is connected via RS-485 and the machine is set to number 2.

Table 11 lists the Hex codes that switch video channels.

Table 11: VP-88K Hex Codes that Switch Video Channels

Switching Video Channels								
	OUT 1	OUT 2	OUT 3	OUT 4	OUT 5	OUT 6	OUT 7	OUT 8
IN 1	01 81 81 81	01 81 82 81	01 81 83 81	01 81 84 81	01 81 85 81	01 81 86 81	01 81 87 81	01 81 88 81
IN 2	01 82 81 81	01 82 82 81	01 82 83 81	01 82 84 81	01 82 85 81	01 82 86 81	01 82 87 81	01 82 88 81
IN 3	01 83 81 81	01 83 82 81	01 83 83 81	01 83 84 81	01 83 85 81	01 83 86 81	01 83 87 81	01 83 88 81
IN 4	01 84 81 81	01 84 82 81	01 84 83 81	01 83 84 81	01 84 85 81	01 84 86 81	01 84 87 81	01 84 88 81
IN 5	01 85 81 81	01 85 82 81	01 85 83 81	01 85 84 81	01 85 85 81	01 85 86 81	01 85 87 81	01 85 88 81
IN 6	01 86 81 81	01 86 82 81	01 86 83 81	01 86 84 81	01 86 85 81	01 86 86 81	01 86 87 81	01 86 88 81
IN 7	01 87 81 81	01 87 82 81	01 87 83 81	01 87 84 81	01 87 85 81	01 87 86 81	01 87 87 81	01 87 88 81
IN 8	01 88 81 81	01 88 82 81	01 88 83 81	01 88 84 81	01 88 85 81	01 88 86 81	01 88 87 81	01 88 88 81

Table 12 lists the Hex codes that switch audio channels.

Table 12: VP-88K Hex Codes that Switch Audio Channels

Switching Audio Channels								
	OUT 1	OUT 2	OUT 3	OUT 4	OUT 5	OUT 6	OUT 7	OUT 8
IN 1	02 81 81 81	02 81 82 81	02 81 83 81	02 81 84 81	02 81 85 81	02 81 86 81	02 81 87 81	02 81 88 81
IN 2	02 82 81 81	02 82 82 81	02 82 83 81	02 82 84 81	02 82 85 81	02 82 86 81	02 82 87 81	02 82 88 81
IN 3	02 83 81 81	02 83 82 81	02 83 83 81	02 83 84 81	02 83 85 81	02 83 86 81	02 83 87 81	02 83 88 81
IN 4	02 84 81 81	02 84 82 81	02 84 83 81	02 83 84 81	02 84 85 81	02 84 86 81	02 84 87 81	02 84 88 81
IN 5	02 85 81 81	02 85 82 81	02 85 83 81	02 85 84 81	02 85 85 81	02 85 86 81	02 85 87 81	02 85 88 81
IN 6	02 86 81 81	02 86 82 81	02 86 83 81	02 86 84 81	02 86 85 81	02 86 86 81	02 86 87 81	02 86 88 81
IN 7	02 87 81 81	02 87 82 81	02 87 83 81	02 87 84 81	02 87 85 81	02 87 86 81	02 87 87 81	02 87 88 81
IN 8	02 88 81 81	02 88 82 81	02 88 83 81	02 88 84 81	02 88 85 81	02 88 86 81	02 88 87 81	02 88 88 81

Table 13 lists the Hex codes that increase or decrease audio input gain.

Table 13: VP-88K Hex Codes that Increase/Decrease Audio Input Gain

	IN 1	IN 2	IN 3	IN 4	IN 5	IN 6	IN 7	IN 8
Increase	18 81 86 81	18 82 86 81	18 83 86 81	18 84 86 81	18 85 86 81	18 86 86 81	18 87 86 81	18 88 86 81
Decrease	18 81 87 81	18 82 87 81	18 83 87 81	18 84 87 81	18 85 87 81	18 86 87 81	18 87 87 81	18 88 87 81

Table 14 lists the Hex codes that set the audio input gain.

Before sending any of the codes in Table 14, the command **2A 86 80 81** must be sent.

Table 14: Hex Codes that Set the Audio Input Gain

IN 1	IN 2	IN 3	IN 4	IN 5	IN 6	IN 7	IN 8	Level [Rel]
16 81 80 81	16 82 80 81	16 83 80 81	16 84 80 81	16 85 80 81	16 86 80 81	16 87 80 81	16 88 80 81	Mute
⋮	⋮	⋮	⋮	⋮	⋮	⋮	⋮	
16 81 8D* 81	16 82 8D* 81	16 83 8D* 81	16 84 8D* 81	16 85 8D* 81	16 86 8D* 81	16 87 8D* 81	16 88 8D* 81	-100dB Mute
⋮	⋮	⋮	⋮	⋮	⋮	⋮	⋮	
16 81 BF 81	16 82 BF 81	16 83 BF 81	16 84 BF 81	16 85 BF 81	16 86 BF 81	16 87 BF 81	16 88 BF 81	-50dB

IN 1	IN 2	IN 3	IN 4	IN 5	IN 6	IN 7	IN 8	Level [Rel]
⋮	⋮	⋮	⋮	⋮	⋮	⋮	⋮	
16 81 F1 81	16 82 F1 81	16 83 F1 81	16 84 F1 81	16 85 F1 81	16 86 F1 81	16 87 F1 81	16 88 F1 81	0dB
⋮	⋮	⋮	⋮	⋮	⋮	⋮	⋮	
16 81 FF 81	16 82 FF 81	16 83 FF 81	16 84 FF 81	16 85 FF 81	16 86 FF 81	16 87 FF 81	16 88 FF 81	+14dB (Max)

* BYTE 3 = 0x80 + Gain Value (0x00-0x7F)

Table 15 lists the Hex codes that increase or decrease the audio output gain.

Table 15: VP-88K Hex Codes that Increase/Decrease the Audio Output Gain

	OUT 1	OUT 2	OUT 3	OUT 4	OUT 5	OUT 6	OUT 7	OUT 8
Increase	18 81 80 81	18 82 80 81	18 83 80 81	18 84 80 81	18 85 80 81	18 86 80 81	18 87 80 81	18 88 80 81
Decrease	18 81 81 81	18 82 81 81	18 83 81 81	18 84 81 81	18 85 81 81	18 86 81 81	18 87 81 81	18 88 81 81

Table 16 lists the Hex codes that set the audio output gain.

Before sending the any of the codes in Table 16, the command **2A 87 80 81** must be sent.

Table 16: VP-88K Hex Codes that Set the Audio Output Gain

OUT 1	OUT 2	OUT 3	OUT 4	OUT 5	OUT 6	OUT 7	OUT 8	Level [Rel]
16 81 80 81	16 82 80 81	16 83 80 81	16 84 80 81	16 85 80 81	16 86 80 81	16 87 80 81	16 88 80 81	Mute
⋮	⋮	⋮	⋮	⋮	⋮	⋮	⋮	
16 81 8D* 81	16 82 8D* 81	16 83 8D* 81	16 84 8D* 81	16 85 8D* 81	16 86 8D* 81	16 87 8D* 81	16 88 8D* 81	-100dB Mute
⋮	⋮	⋮	⋮	⋮	⋮	⋮	⋮	
16 81 BF 81	16 82 BF 81	16 83 BF 81	16 84 BF 81	16 85 BF 81	16 86 BF 81	16 87 BF 81	16 88 BF 81	-50dB
⋮	⋮	⋮	⋮	⋮	⋮	⋮	⋮	
16 81 F1 81	16 82 F1 81	16 83 F1 81	16 84 F1 81	16 85 F1 81	16 86 F1 81	16 87 F1 81	16 88 F1 81	0dB
⋮	⋮	⋮	⋮	⋮	⋮	⋮	⋮	
16 81 FF 81	16 82 FF 81	16 83 FF 81	16 84 FF 81	16 85 FF 81	16 86 FF 81	16 87 FF 81	16 88 FF 81	+13dB (Max)

*BYTE 3 = 0x80 + Gain Value (0x00-0x7F)

15 Kramer Protocol

Section 15.1 describes how to switch between Protocol 3000 and Protocol 2000¹. Section 15.2 defines Protocol 3000. Section 15.3 defines Protocol 2000.

By default, the **VP-88K** is set to Kramer’s protocol 3000, but it is also compatible with Protocol 2000.

15.1 Switching Protocols

You can switch protocols either via the front panel buttons (see Section 15.1.1) or by sending protocol commands (see Section 15.1.2).

¹ You can download our user friendly “Software for Calculating Hex Codes for Protocol 2000” from the technical support section on our Web site at: <http://www.kramerelectronics.com>

15.1.1 Switching Protocols via the Front Panel Buttons

To switch from protocol 3000 to protocol 2000, press and hold¹ the OUT 1 and OUT 2 buttons for a few seconds.

To switch from protocol 2000 to protocol 3000, press and hold the OUT 1 and OUT 3 buttons for a few seconds.

15.1.2 Switching Protocols via Protocol Commands

To switch from Protocol 3000 to Protocol 2000, send the following command:

- #P2000<CR>

To switch from Protocol 2000 to Protocol 3000, send the following command:

- 0x38, 0x80, 0x83, 0x81

The Windows®-based Kramer control software² operates with Protocol 2000. If the VP-88K is set to protocol 3000, it is automatically switched to Protocol 2000.

15.2 Kramer Protocol 3000

This RS-232/RS-485 communication protocol³ lets you control the machine from any standard terminal software (for example, Windows® HyperTerminal) and uses a data rate of 115200 baud, with no parity, 8 data bits, and 1 stop bit.

15.2.1 Protocol 3000 Syntax

Host message format:

Start	Address (optional)	Body	Delimiter
#	<i>Destination_id@</i>	message	CR

Simple command (commands string with only one command without addressing):

start	body	delimiter
#	Command SP Parameter_1,Parameter_2,...	CR

Commands string (formal syntax with commands concatenation and addressing):

Address@ **Command_1** *Parameter1_1,Parameter1_2,... |Command_2
Parameter2_1,Parameter2_2,... |Command_3 Parameter3_1,Parameter3_2,...
|...CR*

Device message format:

Start	Address (optional)	Body	Delimiter
-------	--------------------	------	-----------

¹ Not as part of a switching operation

² Download the latest software from our Web site at <http://www.kramerelectronics.com>

³ Not available at the time of printing. Refer to our Web site at <http://www.kramerelectronics.com> for details

~	Sender_id@	message	CR LF
---	------------	---------	-------

Device long response (**Echoing command**):

Start	Address (optional)	Body	Delimiter
~	Sender_id@	command SP [param1 ,param2 ...] result	CR LF

CR = Carriage return (ASCII 13 = 0x0D)

LF = Line feed (ASCII 10 = 0x0A)

SP = Space (ASCII 32 = 0x20)

15.2.2 Command Parts Details

Command:

Sequence of ASCII letters ('A'-'Z', 'a'-'z' and '-').

Command will separate from parameters with at least single space.

Parameters:

Sequence of Alfa-Numeric ASCII chars ('0'-'9','A'-'Z','a'-'z' and some special chars for specific commands), parameters will be separated by commas.

Message string:

Every command must to be entered as part of message string that begin with **message starting char** and end with **message closing char**, note that string can contain more then one command separated by pipe ("|") char.

Message starting char:

'#' for host command/query.

'-' for machine response.

Device address (Optional, for Knet):

Knet Device ID follow by '@' char.

Query sign = '?', will follow after some commands to define query request.

Message closing char =

Host messages - Carriage Return (ASCII 13), will be referred to by **CR** in this document.

Machine messages - Carriage Return (ASCII 13) + Line-Feed (ASCII 10), will be referred to by **CRLF**

Spaces between parameters or command parts will be ignored.

Commands chain separator char:

When **message string** contains more than one command, commands will be separated by pipe ("|").

Commands entering:

If terminal software used to connect over serial \ ethernet \ USB port, that possible to directly enter all commands characters (**CR** will be entered by Enter key, that key send also **LF**, but this char will be ignored by commands parser).

Sending commands from some controllers (like Crestron) require coding some characters in special form (like \X##). Anyway, there is a way to enter all ASCII characters, so it is possible to send all commands also from controller.

(Similar way can use for URL \ Telnet support that maybe will be added in future).

Commands forms:

Some commands have short name syntax beside the full name to allow faster typing, response is always in long syntax.

Commands chaining:

It is possible to enter multiple commands in same string by '|' char (pipe).

In this case the **message starting char** and the **message closing char** will be entered just one time, in the string beginning and at the end.

All the commands in string will not execute until the closing char will be entered.

Separate response will be sent for every command in the chain.

Input string max length:

64 characters.

Backward support:

Design note: transparent supporting for protocol 2000 will be implemented by switch protocol command from protocol 3000 to protocol 2000, in protocol 2000 there is already such a command to switch protocol to ASCII protocol (#56 : H38 H80 H83 H81).

Table 17: Instruction Codes for Protocol 3000

Help commands		
Command	Syntax	Response
Protocol Handshaking	#CR	~OKCRLF

Device initiated messages	
Command	Syntax
Start message	Kramer Electronics LTD. , Device Model Version Software Version



Kramer Protocol

Device initiated messages	
Command	Syntax
Start message	Kramer Electronics LTD., Device Model Version Software Version
Switcher actions	
Audio-video channel has switched (AFV mode)	AV [IN>OUT]
Video channel has switched (Breakaway mode)	VID [IN>OUT]
Audio channel has switched (Breakaway mode)	AUD [IN>OUT]

Result codes (errors)	
	Syntax
No error. Command running succeeded	COMMAND PARAMETERS OK
Protocol Errors	
Syntax Error	ERR001
Command not available for this device	ERR002
Parameter is out of range	ERR003
Unauthorized access (running command without the match login).	ERR004

Basic routing commands		
Command	Syntax	Response
Switch audio & video	AV [IN>OUT] , [IN>OUT] , ...	AV [IN>OUT] , [IN>OUT] ... [RESULT]

Switch video only	VID [IN>OUT] , [IN>OUT] , ... Short form: V [IN>OUT] , [IN>OUT] , ...	VID [IN>OUT] , [IN>OUT] ... [RESULT]
-------------------	------------------------------------------------------------------------------------------------------------------	-----------------------------------------------------------------

Note:

When AFV mode is active, this command will switch also audio. If audio is breakaway – device display mode will change to show audio connections status.

Switch audio only	AUD [IN>OUT] , [IN>OUT] , ... Short form: A [IN>OUT] , [IN>OUT] , ...	AUD [IN>OUT] , [IN>OUT] ... [RESULT]
-------------------	------------------------------------------------------------------------------------------------------------------	-----------------------------------------------------------------

Note: When AFV mode is active, this command will switch also video.

Read video connection	VID? [OUT] Short form: V? [OUT] VID? *	VID [IN>OUT] VID [IN>1] , [IN>2] , ...
-----------------------	------------------------------------------------------------	-----------------------------------------------------------------------------

Read audio connection	AUD? [OUT] Short form: A? [OUT] AUD? *	AUD [IN>OUT] AUD [IN>1] , [IN>2] , ...
-----------------------	------------------------------------------------------------	-----------------------------------------------------------------------------

Parameters Description:

[IN] = Input number or '0' to disconnect output.

'>' = Connection character between in and out parameters.

[OUT] = Output number or '*' for all outputs.

Examples:

Switch Video and Audio input 3 to output 7	#AV 3>7 CR	~AV 3>7 OK CRLF
Switch Video input 2 to output 4	#V 2>4 CR	~VID 2>4 OK CRLF

Kramer Protocol

Switch Video input 4 to output 2 in machine number 6	#6@VID 4>2 <code>CR</code>	~6@VID 4>2 OK <code>CRLF</code>
Disconnect Video and Audio Output 4	#AV 0>4 <code>CR</code>	~AV 0>4 OK <code>CRLF</code>
Switch Video Input 3 to All Outputs	#V 3>* <code>CR</code>	~VID 3>* OK <code>CRLF</code>
Chaining Multiple commands*	<p>#AV 1>* V 3>4, 2>2, 82>1, 0>2 V 82>3 A 0>1 V? *<code>CR</code></p> <p>First switch all Audio and video outputs from input 1, Then switch video input 3 to output 4, video input 2 to output 2, video input and disconnect video output 2.</p> <p>Then switch audio input 3 to output 2, Then disconnect audio output 1. Then get status of all links (assume this is 4x4 matrix). Commands processing start after entering <code>CR</code>, response will sent for each command after processing it.</p>	<p>~AV 1>* OK<code>CRLF</code> ~VID 1>2, 3>4 OK<code>CRLF</code> ~VID 82>3 <code>ERR###</code> <code>CRLF</code> ~AUD 0>1 OK<code>CRLF</code> ~V 1>1, 0>2, 1>3, 3>4 <code>CRLF</code></p>

Signal Status commands		
Command	Syntax	Response
Change signal status	-----	SIGNAL <code>INPUT</code> , <code>STATUS</code>
Get signal status	SIGNAL? <code>INPUT</code>	SIGNAL <code>INPUT</code> , <code>STATUS</code>

Parameters Description:

`INPUT` = Input number, '*' for all.

`STATUS` = Signal state:

"0" or "off" for not existent signal.

"1" or "on" for existent signal.

Preset commands		
Command	Syntax	Response
Store current connections to preset	PRST-STO <code>PRESET</code> Short form: PSTO <code>PRESET</code>	PRST-STO <code>PRESET</code> <code>RESULT</code>
Recall saved preset	PRST-RCL <code>PRESET</code> Short form: PRCL <code>PRESET</code>	PRST-RCL <code>PRESET</code> <code>RESULT</code>
Delete saved preset	PRST-DEL <code>PRESET</code> Short form: PDEL <code>PRESET</code>	PRST-DEL <code>PRESET</code> <code>RESULT</code>
Read video connections from saved preset	PRST-VID? <code>PRESET</code> <code>OUT</code> Short form: PVID? <code>PRESET</code> <code>OUT</code> PRST-VID? <code>PRESET</code> , *	PRST-VID <code>PRESET</code> , <code>IN</code> > <code>OUT</code> PRST-VID <code>PRESET</code> , <code>IN</code> >1, <code>IN</code> >2,...
Read audio connections from saved preset	PRST-AUD? <code>PRESET</code> <code>OUT</code> Short form: PAUD? <code>PRESET</code> <code>OUT</code> PRST-AUD? <code>PRESET</code> , *	PRST-AUD <code>PRESET</code> : <code>IN</code> > <code>OUT</code> PRST-AUD <code>PRESET</code> : <code>IN</code> >1, <code>IN</code> >2,...
Read saved presets list	PRST-LST? Short form: PLST?	PRST-LST <code>PRESET</code> ; <code>PRESET</code> , ...

Kramer Protocol

Preset commands		
Command	Syntax	Response
Parameters Description: PRESET = Preset number. OUT = Output in preset to show for, "*" for all.		

Examples		
Store current Audio & Video connections to preset 5	#PRST-STR 5 CR	~PRST-STR 5 OK CRLF
Recall Audio & Video connections from preset 3	#PRCL 3 CR	~PRST-RCL 3 OK CRLF
Show source of video output 2 from preset 3	#PRST-VID? 3,2 CR	~PRST-VID 3: 4>2 CRLF

Operation commands		
Command	Syntax	Response
Lock front panel	LOCK-FP LOCK-MODE Short form: LCK LOCK-MODE	LOCK-FP LOCK-MODE RESULT
Get front panel locking state	LOCK-FP?	LOCK-FP LOCK-MODE
Parameters Description: LOCK-MODE = Front panel locking state: "0" or "off" to unlock front panel buttons. "1" or "on" to lock front panel buttons.		
Restart device	RESET	RESET OK
Switch to protocol 2000*	P2000	P2000 OK
* Protocol 2000 has command to switch back to ASCII protocol (like protocol 3000)		

Audio parameters commands		
Command	Syntax	Response
Set audio level in specific amplifier stage.	AUD-LVL STAGE CHANNEL VOLUME Short form: ADL STAGE CHANNEL VOLUME	AUD-LVL STAGE CHANNEL VOLUME RESULT
Read audio volume level	AUD-LVL? STAGE CHANNEL Short form: ADL? STAGE	AUD-LVL STAGE CHANNEL VOLUME
Mute Audio	MUTE MUTE MODE	MUTE MUTE MODE RESULT

Parameters Description:

STAGE =

"In", "Out"

or

Numeric value (present audio processing stage). For example: "0" for Input level, "1" for Pre-Amplifier, "2" for Amplifier (Out) etc.

CHANNEL = Input or Output #

VOLUME = Audio parameter in Kramer units, precede minus sign for negative values.

++ increase current value,

-- decrease current value.

MUTE MODE = 1 – Mute

0 – Unmute

Machine info commands

Command	Syntax	Response
* Time settings commands require admin authorization		
Read in/outs count	INFO-IO?	INFO-IO: IN <u>INPUTS_COUNT</u> , OUT <u>OUTPUTS_COUNT</u>
Read max presets count	INFO-PRST?	INFO-PRST: VID <u>PRESET_VIDEO_COUNT</u> , AUD <u>PRESET_AUDIO_COUNT</u>
Reset configuration to factory default	FACTORY	FACTORY <u>RESULT</u>

Identification commands

Command	Syntax	Response
Protocol Handshaking	# <u>CR</u>	~OK <u>CRLF</u>
Read device model	MODEL?	MODEL <u>MACHINE_MODEL</u>
Read device serial number	SN?	SN <u>SERIAL_NUMBER</u>
Read device firmware version	VERSION?	VERSION <u>MAJOR</u> <u>MINOR</u> <u>BUILD</u> <u>REVISION</u>
Set machine name	NAME <u>MACHINE_NAME</u>	NAME <u>MACHINE_NAME</u> <u>RESULT</u>
Read machine name	NAME?	NAME <u>MACHINE_NAME</u>
Reset machine name to factory default*	NAME-RST	NAME-RST <u>MACHINE_FACTORY_NAME</u> <u>RESULT</u>
*Note: machine name not equal to model name. This name relevance for site viewer identification of specific machine or for network using (with DNS feature on). <u>MACHINE_NAME</u> = Up to 14 Alfa-Numeric chars. * Machine factory name = Model name + last 4 digits from serial number.		
Set machine id number	MACH-NUM <u>MACHINE_NUMBER</u>	MACH-NUM <u>OLD_MACHINE_NUMBER</u> <u>NEW_MACHINE_NUMBER</u> <u>RESULT</u>
* Response will send after machine number has been changed. So the replay with header will be:		



Kramer Protocol

Identification commands		
Command	Syntax	Response
<code>NEW_MACHINE_NUMBER</code>	<code>@MACH-NUM</code>	<code>OLD_MACHINE_NUMBER</code> <code>NEW_MACHINE_NUMBER</code> OK

Network settings commands		
Set IP Address	NET-IP <code>IP_ADDRESS</code> NTIP	NET-IP <code>IP_ADDRESS</code> <code>RESULT</code>
Read IP Address	NET-IP? NTIP?	NET-IP <code>IP_ADDRESS</code>
Read MAC Address	NET-MAC? NTMC	NET-MAC <code>MAC_ADDRESS</code>
Set subnet mask	NET-MASK <code>SUBNET_MASK</code> NTMSK	NET-MASK <code>SUBNET_MASK</code> <code>RESULT</code>
Read subnet mask	NET-MASK? NTMSK?	NET-MASK <code>SUBNET_MASK</code>
Set gateway address	NET-GATE <code>GATEWAY_ADDRESS</code> NTGT	NET-GATE <code>GATEWAY_ADDRESS</code> <code>RESULT</code>
Read subnet mask	NET-GATE? NTGT?	NET-GATE <code>GATEWAY_ADDRESS</code>
Set DHCP mode	NET-DHCP <code>DHCP_MODE</code> NTDH	NET-DHCP <code>DHCP_MODE</code> <code>RESULT</code>
Read subnet mask	NET-DHCP? NTDH?	NET-DHCP <code>DHCP_MODE</code>
<p>DHCP_MODE =</p> <p>0 – Don't use DHCP (Use IP set by factory or IP set command). 1 – Try to use DHCP, if unavailable use IP as above.</p>		
Change protocol ethernet port	ETH-PORT <code>PROTOCOL</code> , <code>PORT</code> ETHP	ETH-PORT <code>PROTOCOL</code> , <code>PORT</code> <code>RESULT</code>
Read protocol ethernet port	ETH-PORT? <code>PROTOCOL</code> ETHP?	ETH-PORT <code>PROTOCOL</code> , <code>PORT</code>
<p>PROTOCOL = TCP / UDP (transport layer protocol) PORT = ethernet port to enter protocol 3000 commands. 1-65535 = User defined port 0 - reset port to factory default (50000 for UDP, 5000 for TCP)</p>		

Advanced switching commands		
Command	Syntax	Response
Set audio follow video mode	AFV <code>AFV-MODE</code>	AFV <code>AFV-MODE</code> <code>RESULT</code>
<p>Note: This command effect device front-panel mode and AUD/VID command.</p>		
Read audio follow video mode	AFV?	AFV <code>AFV-MODE</code>

AFV-MODE = Front panel AFV mode

"0" or "afv" to set front panel switching buttons in audio-follow-video state.

"1" or "brk" to set front panel switching buttons in their previous state when audio.

15.3 Kramer Protocol 2000

This RS-232/RS-485 communication protocol uses four bytes of information as defined below. For RS-232, a null-modem connection between the machine and controller is used. The default data rate is 9600 baud, with no parity, 8 data bits and 1 stop bit.

Table 18: Protocol Definitions

MSB		INSTRUCTION						LSB	
		DESTINATION							
0	D	N5	N4	N3	N2	N1	N0		
7	6	5	4	3	2	1	0		

1st byte

INPUT							
1	I6	I5	I4	I3	I2	I1	I0
7	6	5	4	3	2	1	0

2nd byte

OUTPUT							
1	O6	O5	O4	O3	O2	O1	O0
7	6	5	4	3	2	1	0

3rd byte

MACHINE NUMBER							
1	OVR	X	M4	M3	M2	M1	M0
7	6	5	4	3	2	1	0

4th byte

1st BYTE: Bit 7 – Defined as 0.
D – “DESTINATION”: 0 - for sending information to the switchers (from the PC);
1 - for sending to the PC (from the switcher).
N5...N0 – “INSTRUCTION”
The function that is to be performed by the switcher(s) is defined by the INSTRUCTION (6 bits). Similarly, if a function is performed via the machine’s keyboard, then these bits are set with the INSTRUCTION NO., which was performed. The instruction codes are defined according to the table below (INSTRUCTION NO. is the value to be set for N5...N0).

2nd BYTE: Bit 7 – Defined as 1.
I6...I0 – “INPUT”.
When switching (ie. instruction codes 1 and 2), the INPUT (7 bits) is set as the input number which is to be switched. Similarly, if switching is done via the machine’s front-panel, then these bits are set with the INPUT NUMBER which was switched. For other operations, these bits are defined according to the table.

3rd BYTE: Bit 7 – Defined as 1.
O6...O0 – “OUTPUT”.
When switching (ie. instruction codes 1 and 2), the OUTPUT (7 bits) is set as the output number which is to be switched. Similarly, if switching is done via the machine’s front-panel, then these bits are set with the OUTPUT NUMBER which was switched. For other operations, these bits are defined according to the table.

4th BYTE: Bit 7 – Defined as 1.
Bit 5 – Don’t care.
OVR – Machine number override.
M4...M0 – MACHINE NUMBER.

Kramer Protocol

Used to address machines in a system via their machine numbers. When several machines are controlled from a single serial port, they are usually configured together with each machine having an individual machine number. If the OVR bit is set, then all machine numbers will accept (implement) the command, and the addressed machine will reply.

For a single machine controlled via the serial port, always set M4...M0 = 1, and make sure that the machine itself is configured as MACHINE NUMBER = 1.

Table 19: Instruction Codes for Protocol 2000

Note: All values in the table are decimal, unless otherwise stated.

INSTRUCTION		DEFINITION FOR SPECIFIC INSTRUCTION		NOTE
#	DESCRIPTION	INPUT	OUTPUT	
0	RESET VIDEO	0	0	1
1	SWITCH VIDEO	Set equal to video input which is to be switched (0 = disconnect)	Set equal to video output which is to be switched (0 = to all the outputs)	2
2	SWITCH AUDIO	Set equal to audio input which is to be switched (0 = disconnect)	Set equal to audio output which is to be switched (0 = to all the outputs)	2
3	STORE VIDEO STATUS	Set as SETUP #	0 - to store 1 - to delete	2, 3
4	RECALL VIDEO STATUS	Set as SETUP #	0	2, 3
5	REQUEST STATUS OF A VIDEO OUTPUT	Set as SETUP #	Equal to output number whose status is reqd	4, 3
6	REQUEST STATUS OF AN AUDIO OUTPUT	Set as SETUP #	Equal to output number whose status is reqd	4, 3
8	BREAKAWAY SETTING	0	0 - audio-follow-video 1 - audio breakaway	2
11	REQUEST BREAKAWAY SETTING	Set as SETUP #	0 - Request audio breakaway setting	3, 4, 6
15	REQUEST WHETHER SETUP IS DEFINED / VALID INPUT IS DETECTED	SETUP # or Input #	0 - for checking if setup is defined 1 - for checking if input is valid	8
16	ERROR / BUSY	For invalid / valid input (i.e. OUTPUT byte = 4 or OUTPUT byte = 5), this byte is set as the input #	0 - error 1 - invalid instruction 2 - out of range 3 - machine busy 4 - invalid input 5 - valid input 6 - RX buffer overflow	9, 25
22	SET AUDIO PARAMETER	Equal to input / output number whose parameter is to be set (0 = all)	Set as parameter value	2, 24
24	INCREASE / DECREASE AUDIO PARAMETER	Equal to input / output number whose parameter is to be increased / decreased (0 = all)	0 - increase output 1 - decrease output 2 - increase left output 3 - decrease left output 4 - increase right output 5 - decrease right output 6 - increase input 7 - decrease input 8 - increase left input 9 - decrease left input 10 - increase right input 11 - decrease right input	2
25	REQUEST AUDIO PARAMETER	Equal to input / output number whose parameter is requested	0	6, 24

Kramer Protocol

INSTRUCTION		DEFINITION FOR SPECIFIC INSTRUCTION		NOTE
#	DESCRIPTION	INPUT	OUTPUT	
30	LOCK FRONT PANEL	0 - Panel unlocked 1 - Panel locked	0	2
31	REQUEST WHETHER PANEL IS LOCKED	0	0	16
42	AUDIO PARAMETER SETTINGS FOR INSTRUCTIONS 22, 24, 25	INPUT Bit: 10 - 0=input, 1=output 11 - Left 12 - Right	0 - Gain 1 - Bass 2 - Treble 3 - Midrange 4 - Mix On	24
56	CHANGE TO ASCII	0	Kramer protocol 3000	19
61	IDENTIFY MACHINE	1 - video machine name 2 - audio machine name 3 - video software version 4 - audio software version	0 - Request first 4 digits 1 - Request first suffix 2 - Request second suffix 3 - Request third suffix 10 - Request first prefix 11 - Request second prefix 12 - Request third prefix	13
62	DEFINE MACHINE	1 - number of inputs 2 - number of outputs 3 - number of setups	1 - for video 2 - for audio	14

NOTES on the above table:

NOTE 1 - When the master switcher is reset, (e.g. when it is turned on), the reset code is sent to the PC. If this code is sent to the switchers, it will reset according to the present power-down settings.

NOTE 2 - These are bi-directional definitions. That is, if the switcher receives the code, it will perform the instruction; and if the instruction is performed (due to a keystroke operation on the front panel), then these codes are sent. For example, if the HEX code

01 85 88 83

was sent from the PC, then the switcher (machine 3) will switch input 5 to output 8. If the user switched input 1 to output 7 via the front panel keypad, then the switcher will send HEX codes:

41 81 87 83

to the PC.

When the PC sends one of the commands in this group to the switcher, then, if the instruction is valid, the switcher replies by sending to the PC the same four bytes that it was sent (except for the first byte, where the DESTINATION bit is set high).

NOTE 3 - SETUP # 0 is the present setting. SETUP # 1 and higher are the settings saved in the switcher's memory, (i.e. those used for Store and Recall).

NOTE 4 - The reply to a "REQUEST" instruction is as follows: the same instruction and INPUT codes as were sent are returned, and the OUTPUT is assigned the value of the requested parameter. The replies to instructions 10 and 11 are as per the definitions in instructions 7 and 8 respectively. For example, if the present status of machine number 5 is breakaway setting, then the reply to the HEX code

0B 80 80 85

would be HEX codes

4B 80 81 85

NOTE 6 - If INPUT is set to 127 for these instructions, then, if the function is defined on this machine, it replies with OUTPUT=1. If the function is not defined, then the machine replies with OUTPUT=0, or with an error (invalid instruction code).

If the INPUT is set to 126 for these instructions, then, if possible, the machine will return the current setting of this function, even for the case that the function is not defined. For example, for a video switcher which always switches during the VIS of input #1, (and its VIS setting cannot be programmed otherwise), the reply to the HEX code

0A FE 80 81 (ie. request VIS setting, with INPUT set as 126dec)

would be HEX codes

4A FE 81 81 (ie. VIS setting = 1, which is defined as VIS from input #1).

NOTE 8 - The reply is as in TYPE 3 above, except that here the OUTPUT is assigned with the value 0 if the setup is not defined / no valid input is detected; or 1 if it is defined / valid input is detected.



NOTE 9 - An error code is returned to the PC if an invalid instruction code was sent to the switcher, or if a parameter associated with the instruction is out of range (e.g. trying to save to a setup greater than the highest one, or trying to switch an input or output greater than the highest one defined). This code is also returned to the PC if an RS-232 instruction is sent while the machine is being programmed via the front panel. Reception of this code by the switcher is not valid.

NOTE 10 - This code is reserved for internal use.

NOTE 13 - This is a request to identify the switcher/s in the system. If the OUTPUT is set as 0, and the INPUT is set as 1, 2, 5 or 7, the machine will send its name. The reply is the decimal value of the INPUT and OUTPUT. For example, for a 2216, the reply to the request to send the audio machine name would be (HEX codes):

7D 96 90 81 (i.e. 128dec+ 22dec for 2nd byte, and 128dec+ 16dec for 3rd byte).

If the request for identification is sent with the INPUT set as 3 or 4, the appropriate machine will send its software version number. Again, the reply would be the decimal value of the INPUT and OUTPUT - the INPUT representing the number in front of the decimal point, and the OUTPUT representing the number after it. For example, for version 3.5, the reply to the request to send the version number would be (HEX codes):

7D 83 85 81 (i.e. 128dec+ 3dec for 2nd byte, 128dec+ 5dec for 3rd byte).

If the OUTPUT is set as 1, then the ASCII coding of the lettering following the machine's name is sent. For example, for the VS-7588YC, the reply to the request to send the first suffix would be (HEX codes):

7D D9 C3 81 (i.e. 128dec+ ASCII for "Y"; 128dec+ ASCII for "C").

NOTE 14 - The number of inputs and outputs refers to the specific machine which is being addressed, not to the system. For example, if six 16X16 matrices are configured to make a 48X32 system (48 inputs, 32 outputs), the reply to the HEX code

3E 82 81 82 (ie. request the number of outputs)

would be HEX codes

7E 82 90 82

ie. 16 outputs

NOTE 16 - The reply to the "REQUEST WHETHER PANEL IS LOCKED" is as in NOTE 4 above, except that here the OUTPUT is assigned with the value 0 if the panel is unlocked, or 1 if it is locked.

NOTE 19 - After this instruction is sent, the unit will respond to the ASCII command set defined by the OUTPUT byte. The ASCII command to operate with the HEX command set must be sent in order to return to working with HEX codes.

NOTE 24 - Further information needed in instructions 21, 22, 25 and 26, is sent using instruction 42 - which is sent prior to the instruction. For example, to request the audio gain value of right input # 9, send hex codes

2A 84 80 81

and then send HEX codes

19 89 81 81.

To set MIX mode, send hex codes

2A 81 84 81

and then send HEX codes

16

NOTE 25 - For units which detect the validity of the video inputs, Instruction 16 will be sent whenever the unit detects a change in the state of an input (in real-time).

For example, if input 3 is detected as invalid, the unit will send the HEX codes

10 83 84 81

If input 7 is detected as valid, then the unit will send HEX codes

10 87 85 81.

LIMITED WARRANTY

Kramer Electronics (hereafter *Kramer*) warrants this product free from defects in material and workmanship under the following terms.

HOW LONG IS THE WARRANTY

Labor and parts are warranted for seven years from the date of the first customer purchase.

WHO IS PROTECTED?

Only the first purchase customer may enforce this warranty.

WHAT IS COVERED AND WHAT IS NOT COVERED

Except as below, this warranty covers all defects in material or workmanship in this product. The following are not covered by the warranty:

1. Any product which is not distributed by Kramer, or which is not purchased from an authorized Kramer dealer. If you are uncertain as to whether a dealer is authorized, please contact Kramer at one of the agents listed in the Web site www.kramerelectronics.com.
2. Any product, on which the serial number has been defaced, modified or removed, or on which the WARRANTY VOID IF TAMPERED sticker has been torn, reattached, removed or otherwise interfered with.
3. Damage, deterioration or malfunction resulting from:
 - i) Accident, misuse, abuse, neglect, fire, water, lightning or other acts of nature
 - ii) Product modification, or failure to follow instructions supplied with the product
 - iii) Repair or attempted repair by anyone not authorized by Kramer
 - iv) Any shipment of the product (claims must be presented to the carrier)
 - v) Removal or installation of the product
 - vi) Any other cause, which does not relate to a product defect
 - vii) Cartons, equipment enclosures, cables or accessories used in conjunction with the product

WHAT WE WILL PAY FOR AND WHAT WE WILL NOT PAY FOR

We will pay labor and material expenses for covered items. We will not pay for the following:

1. Removal or installations charges.
2. Costs of initial technical adjustments (set-up), including adjustment of user controls or programming. These costs are the responsibility of the Kramer dealer from whom the product was purchased.
3. Shipping charges.

HOW YOU CAN GET WARRANTY SERVICE

1. To obtain service on you product, you must take or ship it prepaid to any authorized Kramer service center.
2. Whenever warranty service is required, the original dated invoice (or a copy) must be presented as proof of warranty coverage, and should be included in any shipment of the product. Please also include in any mailing a contact name, company, address, and a description of the problem(s).
3. For the name of the nearest Kramer authorized service center, consult your authorized dealer.

LIMITATION OF IMPLIED WARRANTIES

All implied warranties, including warranties of merchantability and fitness for a particular purpose, are limited in duration to the length of this warranty.

EXCLUSION OF DAMAGES

The liability of Kramer for any effective products is limited to the repair or replacement of the product at our option. Kramer shall not be liable for:

1. Damage to other property caused by defects in this product, damages based upon inconvenience, loss of use of the product, loss of time, commercial loss, or.
2. Any other damages, whether incidental, consequential or otherwise. Some countries may not allow limitations on how long an implied warranty lasts and/or do not allow the exclusion or limitation of incidental or consequential damages, so the above limitations and exclusions may not apply to you.

This warranty gives you specific legal rights, and you may also have other rights, which vary from place to place.

NOTE: All products returned to Kramer for service must have prior approval. This may be obtained from your dealer.

This equipment has been tested to determine compliance with the requirements of:

- EN-50081: "Electromagnetic compatibility (EMC); generic emission standard.
Part 1: Residential, commercial and light industry"
- EN-50082: "Electromagnetic compatibility (EMC) generic immunity standard.
Part 1: Residential, commercial and light industry environment".
- CFR-47: FCC* Rules and Regulations:
Part 15: "Radio frequency devices
Subpart B Unintentional radiators"

CAUTION!

- Servicing the machines can only be done by an authorized Kramer technician. Any user who makes changes or modifications to the unit without the expressed approval of the manufacturer will void user authority to operate the equipment.
- Use the supplied DC power supply to feed power to the machine.
- Please use recommended interconnection cables to connect the machine to other components.
* FCC and CE approved using STP cable (for twisted pair products)





For the latest information on our products and a list of Kramer distributors visit www.kramerelectronics.com where updates to this user manual may be found.

We welcome your questions, comments, and feedback.



Caution

Safety Warning:

Disconnect the unit from the power supply before opening/servicing.



Kramer Electronics, Ltd.

Web site: www.kramerelectronics.com

E-mail: info@kramerelect.com

P/N: 2900-000599 REV 2