

**Kramer Electronics, Ltd.**



# **USER MANUAL**

**Model:**

**VS-44HC**

*4x4 Home Entertainment Matrix Switcher*

## Contents

<b>1</b>	<b>Introduction</b>	<b>1</b>
<b>2</b>	<b>Getting Started</b>	<b>1</b>
<b>3</b>	<b>Overview</b>	<b>2</b>
3.1	Terminology Used in this User Manual	3
<b>4</b>	<b>Your VS-44HC 4x4 Home Entertainment Matrix Switcher</b>	<b>3</b>
<b>5</b>	<b>Installing the VS-44HC on a Rack</b>	<b>7</b>
<b>6</b>	<b>Connecting the VS-44HC</b>	<b>8</b>
6.1	Connecting the VS-44HC Rear Panel	8
6.2	Connecting the Audio Signals	10
6.3	Setting the Dipswitches	11
6.3.1	Setting the Machine #	11
6.3.2	Setting the IN 2 Audio Signal	12
<b>7</b>	<b>Controlling the VS-44HC</b>	<b>13</b>
7.1	Controlling via RS-232 (for example, using a PC)	13
7.2	Controlling via RS-485	14
7.2.1	Set the Dipswitches	14
7.3	Controlling the VS-44HC via the ETHERNET Port	16
7.3.1	Connecting the ETHERNET Port directly to a PC (Crossover Cable)	16
7.3.2	Connecting the ETHERNET Port via a Network Hub (Straight-Through Cable)	18
7.4	Configuring the Ethernet Port	18
7.4.1	Setting a Virtual Port	20
7.4.2	Setting an Ethernet Connection	21
<b>8</b>	<b>Operating the VS-44HC</b>	<b>22</b>
8.1	Displaying Unit Characteristics	22
8.2	Choosing the Audio-Follow-Video or Breakaway Option	23
8.2.1	Setting the Audio-Follow-Video Option	23
8.2.2	Setting the Breakaway Option	23
8.3	Switching OUT-IN Combinations	23
8.4	Confirming Settings	24
8.4.1	Toggleing between the At Once and Confirm Modes	24
8.4.2	Confirming a Switching Action	24
8.5	Storing/Recalling Input/Output Configurations	25
8.5.1	Storing an Input/Output Configuration	25
8.5.2	Recalling an Input/Output Configuration	25
8.6	Setting and Adjusting the Audio Delay Time	26
8.7	Locking the Front Panel	27
<b>9</b>	<b>Flash Memory Upgrade</b>	<b>28</b>
9.1	Switcher Flash Memory Upgrade	28
9.1.1	Downloading from the Internet	28



9.1.2	Connecting the PC to the RS-232 Port	28
9.1.3	Upgrading Firmware	29
9.2	Ethernet Flash Memory Upgrade	33
9.2.1	Downloading from the Internet	33
9.2.2	Connecting the PC to the RS-232 Port	33
9.2.3	Upgrading Firmware	34
<b>10</b>	<b>Technical Specifications</b>	<b>35</b>
<b>11</b>	<b>Table of Hex Codes for Serial Communication</b>	<b>36</b>
11.1	Hex Codes for Switching	36
11.2	VS-44HC Hex Codes for Setting the Audio Delay Time	36
<b>12</b>	<b>Kramer Protocol 2000</b>	<b>38</b>

## Figures

Figure 1:	VS-44HC 4x4 Home Entertainment Matrix Switcher	4
Figure 2:	VS-44HC Underside View	6
Figure 3:	Connecting the VS-44HC 4x4 Home Entertainment Matrix Switcher	9
Figure 4:	Connecting the VS-44HC Digital Audio Signals	10
Figure 5:	Dipswitch Settings	11
Figure 6:	Connecting a PC without using a Null-modem Adapter	13
Figure 7:	Cascading Individual Units in a Control Configuration via RS-485	15
Figure 8:	RJ-45 PINOUT	16
Figure 9:	Local Area Connection Properties Window	17
Figure 10:	Internet Protocol (TCP/IP) Properties Window	17
Figure 11:	The Ethernet Configuration Manager Window	19
Figure 12:	The Virtual Serial Port Manager Window	20
Figure 13:	The Virtual Serial Port Properties Window	20
Figure 14:	The Virtual Serial Port Properties Window (COM 3 and COM 4)	21
Figure 15:	The Port Window – Selecting a Virtual Serial Port	21
Figure 16:	The Port Window – Selecting a Remote Connection	21
Figure 17:	Storing and Recalling using the Input / Output Buttons	25
Figure 18:	Splash Screen	29
Figure 19:	Atmel – Flip Window	29
Figure 20:	Device Selection Window	30
Figure 21:	Device Selection window	30
Figure 22:	Loading the Hex	31
Figure 23:	RS-232 Window	31
Figure 24:	Atmel – Flip Window (Connected)	32
Figure 25:	Atmel – Flip Window (Operation Completed)	32
Figure 26:	The KFR-Programmer Window	34

## Tables

Table 1: Terminology Used in this User Manual	3
Table 2: Front Panel VS-44HC 4x4 Home Entertainment Matrix Switcher Features	5
Table 3: Rear Panel VS-44HC 4x4 Home Entertainment Matrix Switcher Features	6
Table 4: Dipswitch Settings	11
Table 5: Machine # Dipswitch Settings	11
Table 6: Digital Audio IN 2 Signal Setting	12
Table 7: Crossover Cable RJ-45 PINOUT	16
Table 8: Straight-through Cable RJ-45 PINOUT	18
Table 9: Ethernet Configuration Manager Window Functionality	19
Table 10: 7-segment Display Information	22
Table 11: Maximum Delay Time according to Sampling Rate	26
Table 12: DELAY Button Response	27
Table 13: Technical Specifications of the VS-44HC	35
Table 14: VS-44HC Hex Codes for Switching via RS-232/RS-485	36
Table 15: VS-44HC Hex Codes for Setting the Audio Delay Time	36
Table 16: VS-44HC Hex Codes for increasing the Audio Delay Time	37
Table 17: Protocol Definitions	38
Table 18: Instruction Codes for Protocol 2000	39

## 1 Introduction

Welcome to Kramer Electronics (since 1981): a world of unique, creative and affordable solutions to the infinite range of problems that confront the video, audio and presentation professional on a daily basis. In recent years, we have redesigned and upgraded most of our line, making the best even better! Our 500-plus different models now appear in 8 Groups<sup>1</sup>, which are clearly defined by function.

Congratulations on purchasing your **VS-44HC 4x4 Home Entertainment Matrix Switcher**, which is ideal for the following typical applications:

- Professional audio/video studios
- Home cinema DVD applications

The package includes the following items:

- **VS-44HC 4x4 Home Entertainment Matrix Switcher**
- Power cord
- Null-modem adapter
- Windows®-based Kramer control software<sup>2</sup>
- Windows®-based Ethernet Configuration Manager and Virtual Serial Port Manager
- Infra-red remote control transmitter (including the required battery and a separate user manual<sup>3</sup>)
- This user manual<sup>3</sup>

## 2 Getting Started

We recommend that you:

- Unpack the equipment carefully and save the original box and packaging materials for possible future shipment
- Review the contents of this user manual
- Use Kramer high performance high resolution cables<sup>4</sup>

---

1 GROUP 1: Distribution Amplifiers; GROUP 2: Video and Audio Switchers, Matrix Switchers and Controllers; GROUP 3: Video, Audio, VGA/XGA Processors; GROUP 4: Interfaces and Sync Processors; GROUP 5: Twisted Pair Interfaces; GROUP 6: Accessories and Rack Adapters; GROUP 7: Scan Converters and Scalers; and GROUP 8: Cables and Connectors

2 Downloadable from our Web site at <http://www.kramerelectronics.com>

3 Download up-to-date Kramer user manuals from our Web site: <http://www.kramerelectronics.com>

4 The complete list of Kramer cables is on our Web site at <http://www.kramerelectronics.com>

### 3 Overview

The **VS-44HC** is a true 4x4 matrix switcher for YUV (Y, Pb/Cb, Pr/Cr) component video and digital audio (S/PDIF) signals. The high quality **VS-44HC** lets you simultaneously route any of the 4 inputs to any or all of the 4 outputs. The component video and S/PDIF input and output signals are on RCA connectors, and the S/PDIF channel 2 is also available on optical (TOSLINK<sup>1</sup>) input/output connectors.

The **VS-44HC 4x4 Home Entertainment Matrix Switcher** features:

- A video bandwidth of over 200MHz that ensures transparent performance
- An audio channel sampling rate of up to 192kHz, including multi-channel audio (suitable for multi-channel applications, like AC3)
- A built-in digital audio delay line, which corrects lip sync errors, so that the audio delay will match the video delay
- DC coupled video inputs and outputs
- Audio-follow-video and breakaway options
- Storing and recalling setups
- A TAKE button for precise switch control
- A LOCK button to prevent tampering with the front panel

Control the **VS-44HC** using the front panel buttons, or remotely via:

- RS-232 and RS-485 serial commands transmitted by a touch screen system, PC, or other serial controller
- The Kramer infra-red remote control transmitter
- The ETHERNET

To achieve the best performance:

- Connect only good quality connection cables, thus avoiding interference, deterioration in signal quality due to poor matching, and elevated noise levels (often associated with low quality cables)
- Avoid interference from neighboring electrical appliances that may adversely influence signal quality and position your Kramer **VS-44HC** away from moisture, excessive sunlight and dust

---

<sup>1</sup> A digital audio optical connector found on many consumer audio devices

### 3.1 Terminology Used in this User Manual

Table 1 defines some terms that are used in this user manual:

*Table 1: Terminology Used in this User Manual*

Term	Definition
802.3	The standard specification for ETHERNET that is maintained by the Institute of Electrical and Electronics Engineers (IEEE).
Dynamic Host Configuration Protocol (DHCP)	Allows the network administrator to distribute IP addresses from a central point and automatically send a new IP address when an Ethernet point is plugged into a different network location.
Gateway	A network position serving as an entry to another network. On the Internet, a node or stopping point can be either a gateway node or a host (end-point) node.
IP Address	A 32-binary digit number that identifies each sender or receiver (within a network via a particular server or workstation) of data (HTML pages or e-mails) that is sent in packets across the Internet. Every device connected to an IP network must have a unique IP address. This address is used to reference the specific unit.
Local Area Network (LAN)	Computers sharing a common communications line or wireless link, which often share a server within a defined geographic area.
Media Access Control (MAC) Address	A computer's unique hardware number (or address) in a LAN or other network. On an Ethernet LAN, the (MAC) address is identical to the Ethernet address.
Transmission Control Protocol/Internet Protocol (TCP/IP)	The basic communication language or protocol of the Internet that breaks the message into appropriately sized packets for the network, and can be used as a communications protocol in an intranet or an extranet.

## 4 Your VS-44HC 4x4 Home Entertainment Matrix Switcher

Figure 1, Table 2 and Table 3 define the **VS-44HC 4x4 Home Entertainment Matrix Switcher**:

Your VS-44HC 4x4 Home Entertainment Matrix Switcher

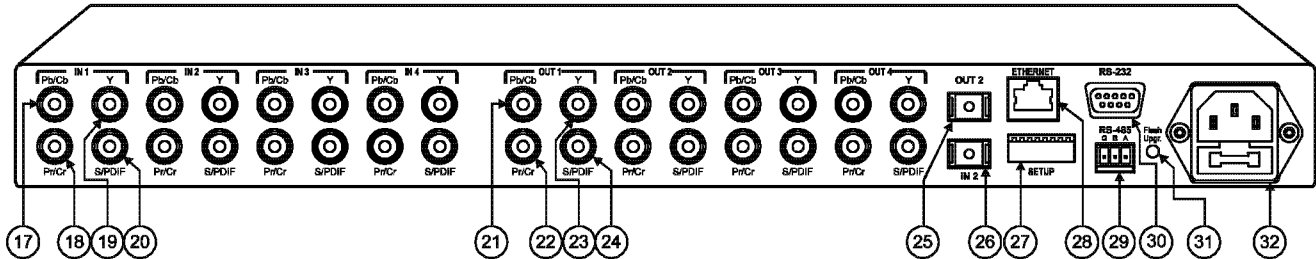
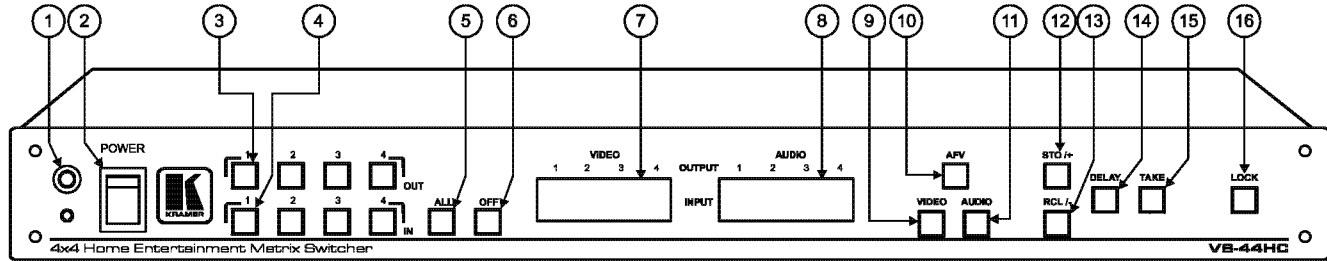

Figure 1: VS-44HC 4x4 Home Entertainment Matrix Switcher



Table 2: Front Panel VS-44HC 4x4 Home Entertainment Matrix Switcher Features

#	Feature	Function
1	IR Receiver	The red LED is illuminated when receiving signals from the infra-red remote control transmitter
2	POWER Switch	Illuminated switch for turning the unit ON or OFF
3	OUT Buttons	Select the output to which the input is switched (from 1 to 4)
4	IN Buttons	Select the input to switch to the output (from 1 to 4)
5	ALL Button	Pressing ALL followed by an IN button, connects that input to all outputs <sup>1</sup>
6	OFF Button	An OFF-OUT combination disconnects that output from the inputs; an OFF-ALL combination disconnects all the outputs
7	VIDEO 7-segment Display	Displays the selected video IN switched to the OUT (marked above each input) <sup>2</sup>
8	AUDIO 7-segment Display	Displays the selected audio IN switched to the OUT (marked above each input) <sup>3</sup> ; When adjusting the audio delay time, shows the delay time in milliseconds
9	VIDEO Button	When illuminated <sup>4</sup> , the subsequent actions relate to video. Press to toggle
10	AFV Button	When illuminated <sup>5</sup> , the subsequent actions relate to the video and audio channels. The audio channels follow the video channels. Press to toggle
11	AUDIO Button	When illuminated <sup>6</sup> , the subsequent actions relate to audio. Press to toggle
12	STO /+ (store) Button	Pressing STO, followed by an output button, stores the current setting <sup>7</sup> ; When adjusting the audio delay, press to increase the delay time
13	RCL /- (recall) Button	Pressing the RCL button and the corresponding OUT key recalls a setup from the non-volatile memory. The stored status blinks. Pressing a different OUT button lets you view <sup>8</sup> another setup. After making your choice, pressing the RCL button again implements the new status; When adjusting the audio delay, press to decrease the delay time
14	DELAY Button	Press to toggle the output 2 DELAY feature between: On – activate the delay Set – set the delay time and Off – turn off the delay (see section 8.6)
15	TAKE Button	Pressing TAKE toggles the mode between the Confirm mode <sup>9</sup> and the At Once mode (user confirmation per action is unnecessary). When the TAKE button flashes (in the confirm mode), pressing it implements pending actions
16	LOCK Button	Disengages/engages the front panel switches

1 For example, press ALL and then input button # 2 to connect IN 2 to all the outputs

2 Also displays the audio sample rate, and so on. Refer to section 8.1

3 Also displays the firmware version number, delay time and so on. Refer to section 8.1

4 The VIDEO button is illuminated when the video breakaway mode is selected

5 The AFV button is illuminated when the AFV mode is selected

6 The AUDIO button is illuminated when the audio breakaway mode is selected

7 For example, press STO and then the OUT button # 3 to store in setup # 3

8 Only view, nothing is implemented at this stage

9 When in the Confirm mode, the TAKE button flashes

Table 3: Rear Panel VS-44HC 4x4 Home Entertainment Matrix Switcher Features

#	Feature		Function
17	IN	Pb/Cb RCA Connectors	Connect to the component (Y, Pb/Cb, Pr/Cr) video source (from IN 1 to IN 4)
18		Pr/Cr RCA Connectors	
19		YRCA Connectors	
20	S/PDIF		Connect to the digital audio source (from IN 1 to IN 4)
21	OUT	Pb/Cb RCA Connectors	Connect to the component (Y, Pb/Cb, Pr/Cr) video acceptor (from OUT 1 to OUT 4)
22		Pr/Cr RCA Connectors	
23		YRCA Connectors	
24	S/PDIF		Connect to the digital audio acceptor (from OUT 1 to OUT 4)
25	OUT 2 TOSLINK Connector		Connect to the digital audio acceptor <sup>1</sup>
26	IN 2 TOSLINK Connector		Connect to the digital audio source <sup>1</sup>
27	SETUP Dipswitches		Dipswitches for setup of the unit (1, 2, 3 and 4 are for setting the machine #; 6 and 7 are for selecting the digital audio source for IN 2, and 8 is for RS 485 termination)
28	ETHERNET Connector		Connects to the PC or other Serial Controller through computer networking LAN
29	RS-485 Terminal Block Port		Pins B (-) and A (+) are for RS-485 connection. If shielded cabling is used for RS-485, then the shield may be connected to PIN G if desired
30	RS-232 DB 9F Port		Connects to the PC or the Remote Controller
31	FLASH Upgr. Button		Push in <sup>2</sup> for "Program" to upgrade the switcher microcontroller to the latest Kramer firmware (see section 9.1.2), or release (the factory default) for normal operation
32	Power Connector with Fuse		AC connector enabling power supply to the unit

The VS-44HC underside is illustrated in Figure 2:

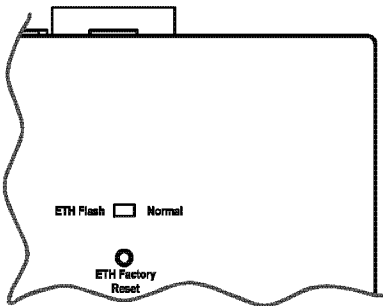

Figure 2: VS-44HC Underside View

Feature	Function
ETH Flash – Normal Switch	Set to ETH Flash to upgrade firmware (see section 9.2); Set to Normal for normal operation
ETH Factory Reset Button	Press to reset to factory default definitions <sup>3</sup> : IP number – 192.168.1.39 Mask – 255.255.255.0 Gateway – 192.168.1.1

1 Use an optical cable, such as Sony’s POC-15A (not included in the package)

2 Using a screwdriver if required

3 First disconnect the power cord and then connect it again while pressing the ETH Factory Reset button. The unit will power up and load its memory with the factory default definitions

## 5 Installing the VS-44HC on a Rack

This section describes what to do before installing on a rack and how to rack mount.

### Before Installing on a Rack

Before installing on a rack, be sure that the environment is within the recommended range:	
Operating temperature range	+5 to +45 Deg. Centigrade
Operating humidity range	5 to 65 % RHL, non-condensing
Storage temperature range	-20 to +70 Deg. Centigrade
Storage humidity range	5 to 95% RHL, non-condensing



**CAUTION!!**

When installing on a 19" rack, avoid hazards by taking care that:

- 1 It is located within the recommended environmental conditions, as the operating ambient temperature of a closed or multi unit rack assembly may exceed the room ambient temperature.
- 2 Once rack mounted, enough air will still flow around the machine.
- 3 The machine is placed straight in the correct horizontal position.
- 4 You do not overload the circuit(s). When connecting the machine to the supply circuit, overloading the circuits might have a detrimental effect on overcurrent protection and supply wiring. Refer to the appropriate nameplate ratings for information. For example, for fuse replacement, see the value printed on the product label.
- 5 The machine is earthed (grounded) in a reliable way and is connected only to an electricity socket with grounding. Pay particular attention to supply connections other than direct connections to the branch circuit (for example, the use of power strips), and that you use only the power cord that is supplied with the machine.

### How to Rack Mount

To rack-mount the machine:

- 1 Attach both ear brackets to the machine. To do so, remove the screws from each side of the machine (3 on each side), and replace those screws through the ear brackets.

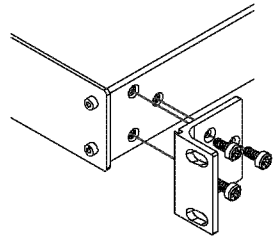

- 2 Place the ears of the machine against the rack rails, and insert the proper screws (not provided) through each of the four holes in the rack ears.

Note that:

- In some models, the front panel may feature built-in rack ears
- Detachable rack ears can be removed for desktop use
- Always mount the machine in the rack before you attach any cables or connect the machine to the power
- If you are using a Kramer rack adapter kit (for a machine that is not 19"), see the Rack Adapters user manual for installation instructions (you can download it at: <http://www.kramerelectronics.com>)

## 6 Connecting the VS-44HC

This section describes how to connect the **VS-44HC**. In particular, how to:

- Connect the **VS-44HC** rear panel (see section 6.1)
- Connect the audio signals (see section 6.2)
- Set the dipswitches (see section 6.3)

### 6.1 Connecting the VS-44HC Rear Panel

To connect the **VS-44HC**, as the example in Figure 3 illustrates, do the following<sup>1</sup>:

1. Connect up to four component video sources<sup>2</sup> (for example, four DVD players) to the three IN RCA connectors Y, Pb/Cb and Pr/Cr (from IN 1 to IN 4) and connect the corresponding digital audio sources to the S/PDIF<sup>3</sup> RCA connectors (see section 6.2).
2. Connect<sup>4</sup> the four sets of three OUT RCA connectors Y, Pb/Cb and Pr/Cr (from OUT 1 to OUT 4) to up to four video acceptors (for example, four plasma displays), and connect the corresponding S/PDIF<sup>5</sup> RCA connectors to the four digital audio acceptors<sup>6</sup> (see section 6.2)
3. Set the dipswitches (see section 6.3).
4. If required, connect a PC and/or controller to the RS-232 port (see section 7.1) and/or the RS-485 port (see section 7.2) and/or the ETHERNET port (see section 7.3).
5. Connect the power cord<sup>7</sup> (not shown in Figure 3).

---

1 Switch OFF the power on each device before connecting it to your VS-44HC. After connecting your VS-44HC, switch on its power and then switch on the power on each device. DO NOT push in the rear panel Flash Program "Flash Upgr." button (see Table 3) and DO NOT switch the ETH Flash switch. These are only used for upgrading to the latest Kramer firmware (see section 9)

2 Although in this example four inputs are connected, you can connect less inputs

3 Or TOSLINK connector for IN 2

4 When less than four outputs are required, connect only those outputs of the VS-44HC that are required, and leave the other outputs unconnected

5 Or TOSLINK connector for OUT 2

6 For example, an AV receiver or the audio connector of the plasma display

7 We recommend that you use only the power cord that is supplied with this machine

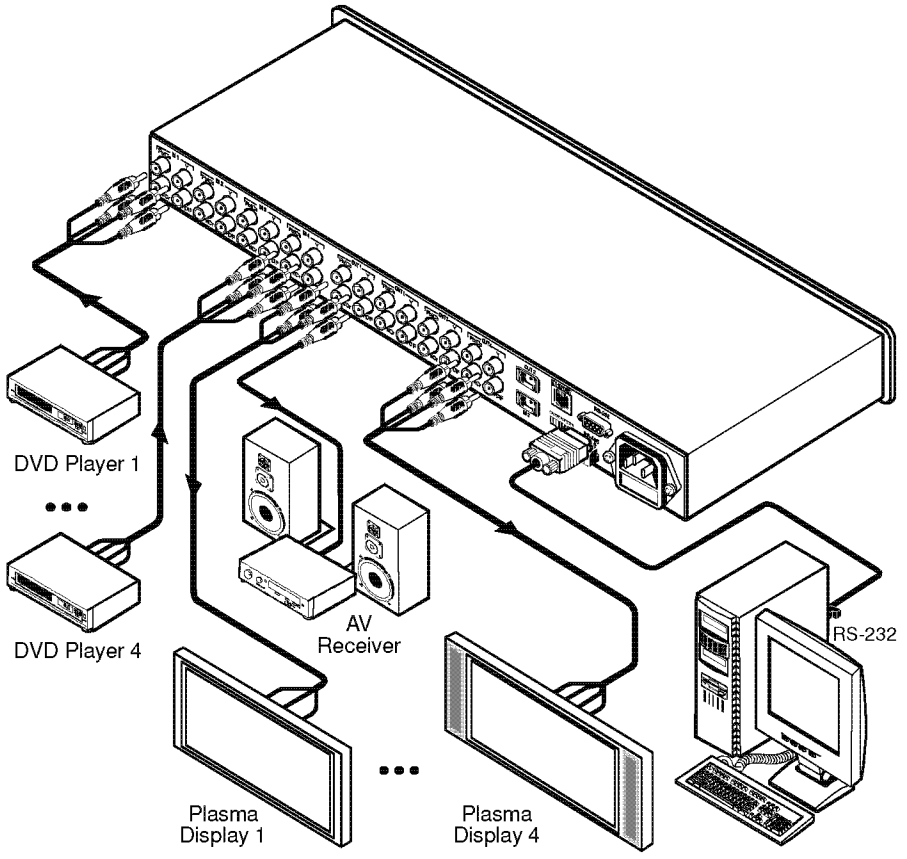

Figure 3: Connecting the VS-44HC 4x4 Home Entertainment Matrix Switcher

## 6.2 Connecting the Audio Signals

The **VS-44HC 4x4 Home Entertainment Matrix Switcher** inputs and outputs digital audio signals in the following formats:

- Four S/PDIF inputs and four S/PDIF outputs on RCA connectors (from IN 1 to IN 4, and from OUT 1 to OUT 4, respectively)
- One TOSLINK input and one TOSLINK output for IN 2 and OUT 2

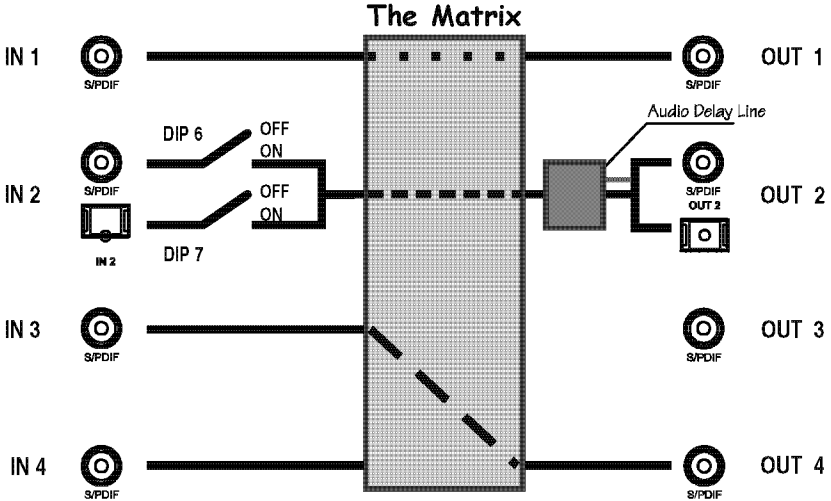

Figure 4: Connecting the VS-44HC Digital Audio Signals

In the example illustrated in Figure 4, IN 1 is switched to OUT 1, IN 3 is switched to OUT 4 and IN 4 is not connected.

The IN 2 digital audio signal can be routed either via the IN 2 S/PDIF connector or the IN 2 TOSLINK connector, depending on the setup of dipswitches 6 and 7 (see section 6.3.2):

- To select the S/PDIF connector, set DIP 6 ON and DIP 7 OFF
- To select the TOSLINK connector, set DIP 7 ON and DIP 6 OFF

The digital audio signal on channel 2 is outputted simultaneously to both the S/PDIF and TOSLINK OUT 2 connectors.

To set the audio delay time, see section 8.6

### 6.3 Setting the Dipswitches

Figure 5 illustrates the factory default dipswitches:

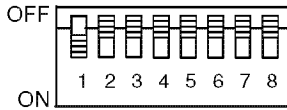

#### SETUP

Figure 5: Dipswitch Settings

Table 4: Dipswitch Settings

DIPS	Function	Description
1, 2, 3, 4	Machine #	Set the MACHINE # (see section 6.3.1)
5	Reserved	OFF
6	S/PDIF	ON for IN 2 S/PDIF digital audio signal; OFF when TOSLINK is selected (see section 6.3.2) <sup>1</sup>
7	Optic	ON for IN 2 TOSLINK digital audio signal; OFF when S/PDIF is selected (see section 6.3.2) <sup>1</sup>
8	RS-485 Termination	ON for RS-485 Line Termination with 120Ω; OFF for no RS-485 Line Termination

#### 6.3.1 Setting the Machine #

To control a unit via RS-232 or RS-485, each unit has to be identified via its unique MACHINE #. Set the machine #<sup>2</sup> on a VS-44HC unit via dipswitches 1, 2, 3 and 4, according to Table 5.

Table 5: Machine # Dipswitch Settings

MACHINE #	DIPSWITCH			
	1	2	3	4
1	ON	OFF	OFF	OFF
2	OFF	ON	OFF	OFF
3	ON	ON	OFF	OFF
4	OFF	OFF	ON	OFF
5	ON	OFF	ON	OFF
6	OFF	ON	ON	OFF
7	ON	ON	ON	OFF
8	OFF	OFF	OFF	ON

MACHINE #	DIPSWITCH			
	1	2	3	4
9	ON	OFF	OFF	ON
10	OFF	ON	OFF	ON
11	ON	ON	OFF	ON
12	OFF	OFF	ON	ON
13	ON	OFF	ON	ON
14	OFF	ON	ON	ON
15	ON	ON	ON	ON

When connecting more than one VS-44HC unit, set a different machine # on each unit. You do not have to number the units in the sequence order as they connect to the PC, but it is essential that each unit is assigned a unique machine number.

<sup>1</sup> Do not set both DIP 6 and DIP 7 ON

<sup>2</sup> When using a single unit, set the unit to MACHINE # 1

### 6.3.2 Setting the IN 2 Audio Signal

You can set the IN 2 digital audio signal to either an S/PDIF digital audio signal or a TOSLINK optical digital audio signal, as Table 6 defines<sup>1</sup>.

*Table 6: Digital Audio IN 2 Signal Setting*

IN 2 Digital Audio Signal	DIPSWITCH	
	6	7
S/PDIF	ON	OFF
TOSLINK	OFF	ON
None	OFF	OFF

---

<sup>1</sup> You cannot set both DIP 6 and DIP 7 ON



## 7 Controlling the VS-44HC

You can control the **VS-44HC** via:

- RS-232 (see section 7.1)
- RS-485 (see section 7.2)
- The Ethernet (see section 7.3)
- The IR remote control transmitter (see the separate user manual)

### 7.1 Controlling via RS-232 (for example, using a PC)

To connect a PC<sup>1</sup> to the **VS-44HC** unit, using the Null-modem adapter provided with the machine (recommended):

- Connect the RS-232 DB9 rear panel port on the Master **VS-44HC** unit to the Null-modem adapter and connect the Null-modem adapter with a 9-wire flat cable to the RS-232 DB9 port on your PC

To connect a PC to the **VS-44HC** unit, without using a Null-modem adapter:

- Connect the RS-232 DB9 port on your PC to the RS-232 DB9 rear panel port on the Master **VS-44HC** unit, as Figure 6 illustrates

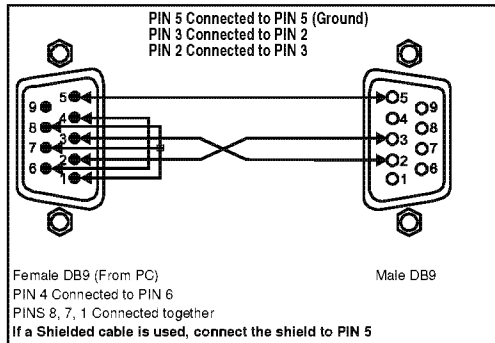

Figure 6: Connecting a PC without using a Null-modem Adapter

<sup>1</sup> Or a master program remote control system such as the Kramer RC-3000

## 7.2 Controlling via RS-485

You can control up to 15 **VS-44HC** units via an RS-485 controller, for example, a PC (equipped with an RS-485 interface) or a Master Programmable Remote Control system such as the Kramer **RC-3000**<sup>1</sup>.

To connect an **RC-3000** to a **VS-44HC** unit (see Figure 7), connect the RS-485 terminal block port on the **RC-3000** to the RS-485 port on the **VS-44HC** unit, as follows:

1. Connect the “A” (+) PIN on the RS-485 rear panel port of the **RC-3000** to the “A” (+) PIN on the RS-485 rear panel port of the **VS-44HC** unit
2. Connect the “B” (-) PIN on the RS-485 rear panel port of the **RC-3000** to the “B” (-) PIN on the RS-485 rear panel port of the **VS-44HC** unit
3. If shielded twisted pair cable is used, the shield may be connected to the “G” (Ground) PIN on one of the units (for example, on the **RC-3000**)

To cascade up to 15 individual **VS-44HC** units, via RS-485, as illustrated in Figure 7, do the following:

1. Connect the component video sources and acceptors, as well as the appropriate digital audio sources and acceptors, as section 6.1 describes.
2. Connect the RS-485 terminal block port on the first **VS-44HC** unit to the RS-485 port on the second **VS-44HC** unit and so on, connecting all the RS-485 ports.

### 7.2.1 Set the Dipswitches

Set the dipswitches, as section 6.3 describes:

- Assign a unique machine #<sup>2</sup> (from 1 to 15) for each **VS-44HC** unit, according to Table 5
- Set DIP 8 ON on the **VS-44HC** unit located at the end of the line (terminating the RS-485 line at 120Ω).  
Set DIP 8 OFF on the other **VS-44HC** units
- Set DIP 5 OFF on all **VS-44HC** units
- Set DIP 6 and DIP 7 according to the IN 2 digital audio input signal (Table 6)

---

<sup>1</sup> Previously known as the VS-3000

<sup>2</sup> In any order

# Controlling the VS-44HC

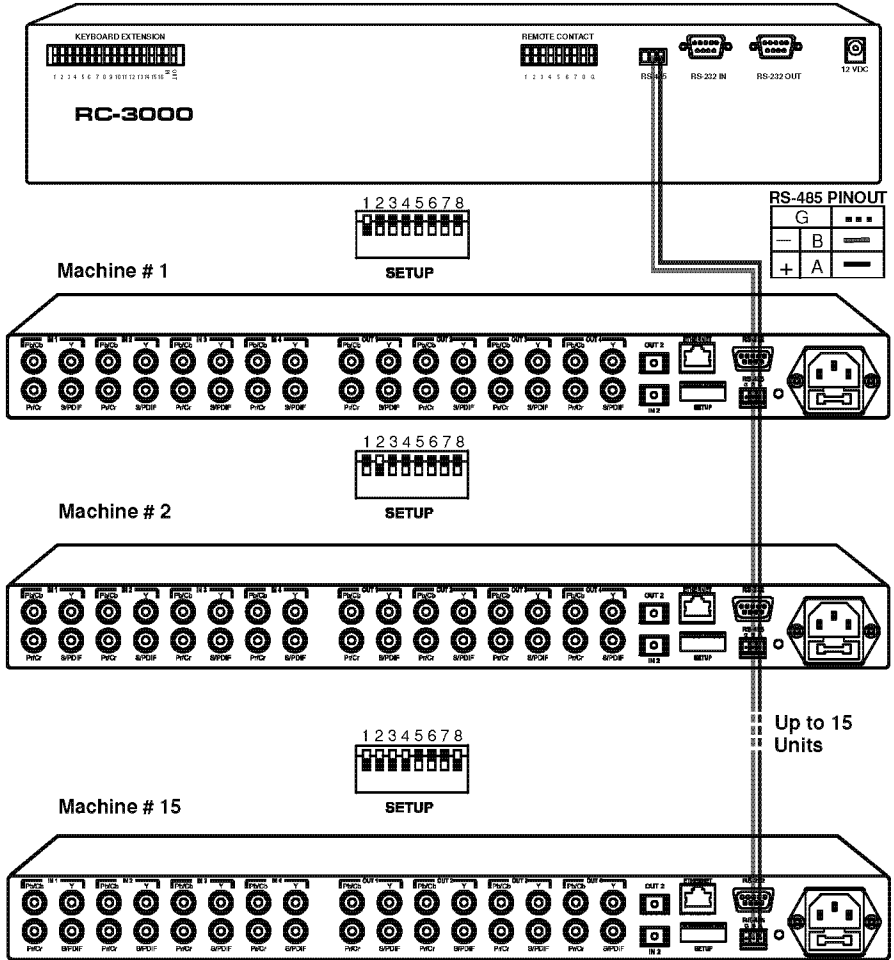

Figure 7: Cascading Individual Units in a Control Configuration via RS-485

### 7.3 Controlling the VS-44HC via the ETHERNET Port

You can connect the **VS-44HC** via the Ethernet, using a crossover cable (see section 7.3.1) for direct connection to the PC or a straight through cable (see section 7.3.2) for connection via a network hub or network router.

#### 7.3.1 Connecting the ETHERNET Port directly to a PC (Crossover Cable)

You can connect the Ethernet port of the **VS-44HC** to the Ethernet port on your PC, via a crossover cable with RJ-45 connectors, as Table 7 and Figure 8 define.

Figure 8: RJ-45 PINOUT

Table 7: Crossover Cable RJ-45 PINOUT

EIA /TIA 568A Side 1		EIA /TIA 568B Side 2	
PIN	Wire Color	PIN	Wire Color
1	White-orange	1	White-green
2	Orange	2	Green
3	White-green	3	White-orange
4	Blue	4	Blue
5	White-blue	5	White-blue
6	Green	6	Orange
7	White-brown	7	White-brown
8	Brown	8	Brown
Pair 1		4 and 5	
Pair 2		1 and 2	
Pair 3		3 and 6	
Pair 4		7 and 8	

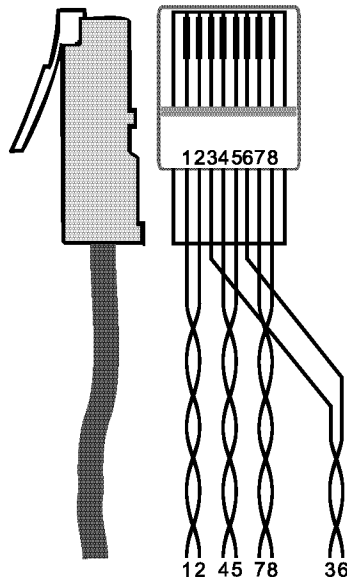

This type of connection is recommended for identification of the factory default IP Address of the **VS-44HC** during the initial configuration

After connecting the Ethernet port, configure your PC as follows:

1. Right-click the My Network Places icon on your desktop.
2. Select **Properties**.
3. Right-click Local Area Connection Properties.
4. Select **Properties**.  
The Local Area Connection Properties window appears.

5. Select the Internet Protocol (TCP/IP) and click the **Properties** Button (see Figure 9).

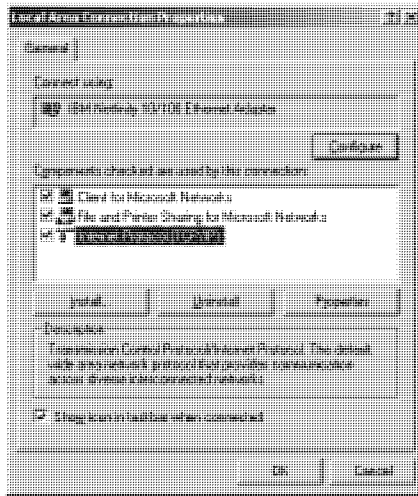

Figure 9: Local Area Connection Properties Window

6. Select Use the following IP address, and fill in the details as shown in Figure 10.
7. Click **OK**.

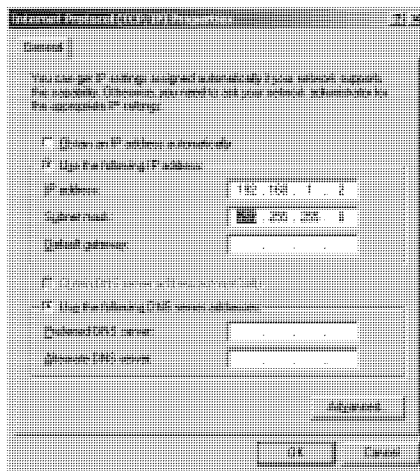

Figure 10: Internet Protocol (TCP/IP) Properties Window

### 7.3.2 Connecting the ETHERNET Port via a Network Hub (Straight-Through Cable)

You can connect the Ethernet port of the **VS-44HC** to the Ethernet port on a network hub or network router, via a straight-through cable with RJ-45 connectors, as Table 8 defines:

Table 8: Straight-through Cable RJ-45 PINOUT

Side 1		Side 2	
PIN	Wire Color	PIN	Wire Color
1	White-orange	1	White-orange
2	Orange	2	Orange
3	White-green	3	White-green
4	Blue	4	Blue
5	White-blue	5	White-blue
6	Green	6	Green
7	White-brown	7	White-brown
8	Brown	8	Brown

## 7.4 Configuring the Ethernet Port

To configure the ETHERNET port, do the following:

1. Connect the ETHERNET port as described in section 7.3.1.
2. Insert the CD-ROM in the CD-ROM drive, double click the Set FC11\_xx.exe<sup>1</sup> file and follow the on-screen instructions<sup>2</sup>. Both the Ethernet Configuration Manager and the Virtual Serial Port Manager are downloaded.
3. Click the appropriate shortcut in the Start menu's Programs folder. The Configuration Manager window (see Figure 11) opens.
4. Click the Search button<sup>3</sup> (or the Action menu's, Search Board command). The MAC Address for the found ETHERNET port appears in the Device List.
5. Change the settings according to your network requirements and then click the Config button (or the Action menu's, Config command) to apply the settings.

Note that clicking the Config button will alter the IP settings of the ETHERNET port

<sup>1</sup> File names are liable to change from time to time

<sup>2</sup> The latest version appears on our Web site at <http://www.kramerelectronics.com>

<sup>3</sup> To automatically search for devices

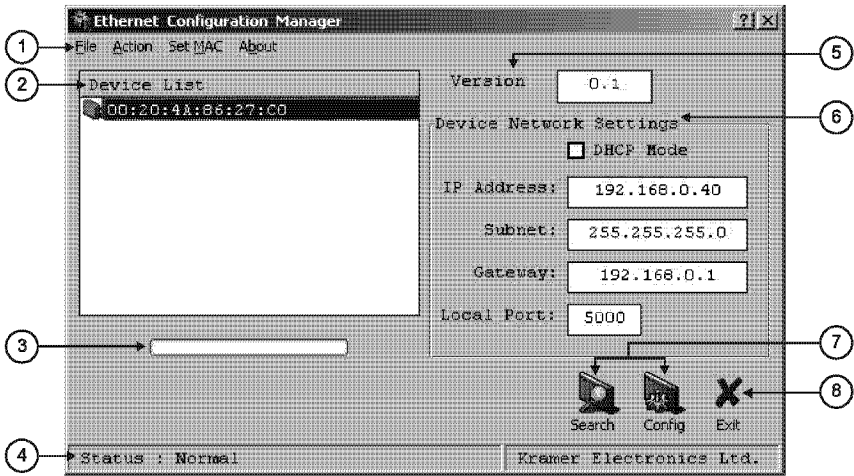

Figure 11: The Ethernet Configuration Manager Window

Table 9: Ethernet Configuration Manager Window Functionality

#	Feature	Function
1	File	The <i>Exit</i> command closes the Configuration Manager application
	Action	The <i>Search Board</i> command seeks the <b>VS-44HC</b> device that connects to the PC via the ETHERNET port, and displays it and its corresponding settings; The <i>Config</i> command adjusts the <b>VS-44HC</b> according to the displayed data
	Set MAC <sup>1</sup>	For factory use only (click the <i>Password</i> command to enter the password)
	About	Displays software information, including the software version
2	Device List	Displays the MAC Address
3	Progress Bar	Shows the progress
4	Status Bar	Shows the status
5	Version	Displays the firmware version
6	Device Network Settings Area	<b>DHCP<sup>1</sup> Mode</b> Check Box: When selected, configures the Ethernet port to obtain an IP address automatically from the DHCP server. When cleared, manual configuration of the Ethernet port is required to obtain an IP address (Static IP) <b>IP Address:</b> A 32-binary digit number obtained from your Network Administrator that identifies the Ethernet port that is currently being configured <b>Subnet:</b> A 32-binary digit number obtained from your Network Administrator, which combined with the IP Address, identifies which network your device is on <b>Gateway:</b> A network position serving as an entry to another network or to the Internet (only relevant in the Active Routing mode)
7	Exit Button	Closes the Configuration Manager application
8	Action Buttons	<b>Search:</b> seeks the devices that connect to the PC via the ETHERNET port, and displays them and their corresponding settings <b>Config:</b> adjusts the according to the displayed data

<sup>1</sup> See the definition in Table 1

### 7.4.1 Setting a Virtual Port

If the control application cannot work with an Ethernet driver, use the Kramer Virtual port driver as follows:

1. Run the Virtual Serial Port Manager Application.  
The Virtual Serial Port Manager window appears (see Figure 12).

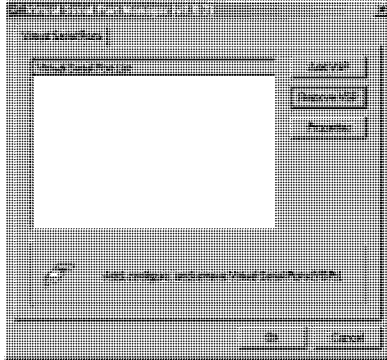

Figure 12: The Virtual Serial Port Manager Window

2. Press the **Add VSP** button to add a serial port and type the IP settings according to the IP address and local port of your **VS-44HC** (see Figure 13).

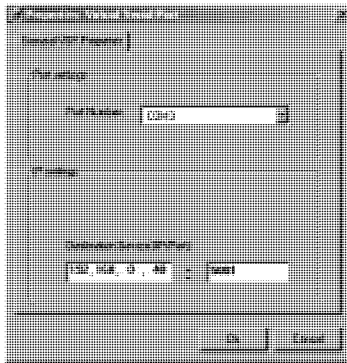

Figure 13: The Virtual Serial Port Properties Window

3. You can set a virtual port for each local port on your **VS-44HC** (see Figure 14).



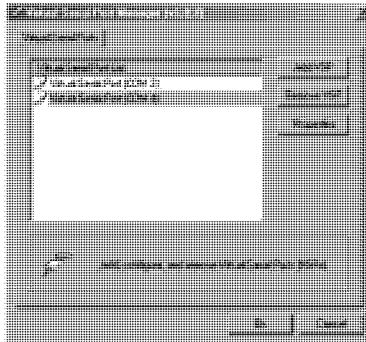

Figure 14: The Virtual Serial Port Properties Window (COM 3 and COM 4)

4. In the control application, choose the COM-port connection according to your virtual serial port connections (see Figure 15).

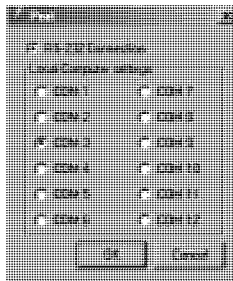

Figure 15: The Port Window – Selecting a Virtual Serial Port

### 7.4.2 Setting an Ethernet Connection

If the control application can directly connect to the Ethernet driver, select the host IP and port number, as illustrated in Figure 16.

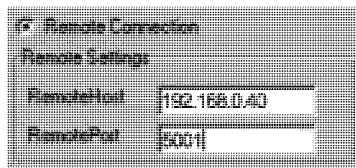

Figure 16: The Port Window – Selecting a Remote Connection

## 8 Operating the VS-44HC

You can operate your **VS-44HC** via:

- The front panel buttons
- RS-232/RS-485 serial commands transmitted by a touch screen system, PC, or other serial controller
- Infra-red remote control transmitter

This section describes:

- The 7-segment displays
- How to use the front panel buttons
- How to set and adjust the audio delay time

### 8.1 Displaying Unit Characteristics

Table 10 defines the information shown on the **VS-44HC** 7-segment displays:

*Table 10: 7-segment Display Information*

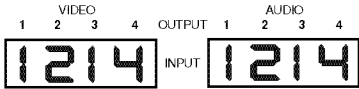
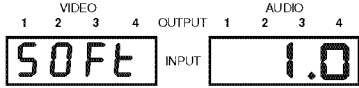
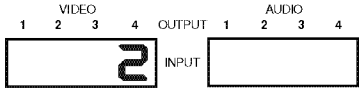
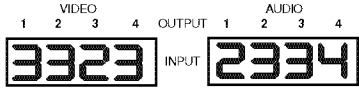
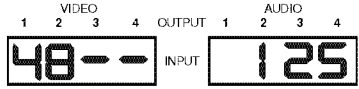
Displayed Information	When:
<ul style="list-style-type: none"> <li>• The video and audio inputs switched to the outputs</li> </ul>	During normal operation: 
<ul style="list-style-type: none"> <li>• The firmware version number (AUDIO display)</li> </ul>	Immediately after switching on the power; and when simultaneously pressing the three IN buttons 1, 2 and 3, for 3 seconds: 
<ul style="list-style-type: none"> <li>• The setup # in which the current status is stored (blinking)</li> </ul>	When storing a set up: 
<ul style="list-style-type: none"> <li>• The audio and video setup to be recalled after momentarily showing the setup # (blinking)</li> </ul>	When recalling a setup: 
<ul style="list-style-type: none"> <li>• The digital audio sampling rate (VIDEO display)</li> <li>• The audio delay time<sup>1</sup> in milliseconds (AUDIO display)</li> </ul>	When setting the audio delay time: 

<sup>1</sup> To set the delay time, see section 8.6

## 8.2 Choosing the Audio-Follow-Video or Breakaway Option

You can switch digital audio (S/PDIF) signals in one of two ways, either:

- Audio-follow-video (AFV), in which all operations and status indicators relate to both the video and the audio channels<sup>1</sup>; or
- Breakaway, in which video and audio channels switch independently

### 8.2.1 Setting the Audio-Follow-Video Option

To set the audio-follow-video (AFV) option:

1. Press the AFV button.  
The AFV button illuminates. The audio will follow the video.
  - If the audio configuration differs from the video configuration, the audio input(s) in the AUDIO 7-segment display, the AUDIO button, and the TAKE button will blink<sup>2</sup>, and require reconfiguring for AFV operation
2. Press the TAKE button to confirm the modification (reconfiguring the audio according to the video).

### 8.2.2 Setting the Breakaway Option

To set the breakaway option, press either the AUDIO (for audio control only) or the VIDEO (for video control only) button:

- If the AUDIO button illuminates, all switching operations relate to the audio section.
- If the VIDEO button illuminates, all switching operations relate to the video section

## 8.3 Switching OUT-IN Combinations

To switch a video/audio input to a video/audio output, do the following:

1. Press an OUT button (either 1, 2, 3, 4 or ALL).  
The corresponding AUDIO and<sup>3</sup>/or VIDEO 7-segment displays blink.
2. Press an IN button (either 1, 2, 3, 4 or OFF).  
The selected input switches to the selected output.

For example, press the ALL button and then the IN button # 2 to connect input # 2 to all the outputs.

---

1 Audio and video connections are the same

2 Warning that changes are about to occur in the audio section

3 When the audio-follow-video option is active (refer to section 8.2)

## 8.4 Confirming Settings

You can choose to work in the At Once or the Confirm mode.

In the At Once mode (TAKE button is not illuminated):

- Pressing an OUT-IN combination implements the switch immediately
- You save time as execution is immediate and actions require no user confirmation
- No protection is offered to correct an erroneous action

In the Confirm mode (TAKE button is lit):

- You can key-in an action and then confirm it by pressing the TAKE button
- Every action requires user confirmation, protecting against erroneous switching
- Execution is delayed until the user confirms the action<sup>1</sup>

### 8.4.1 Toggling between the At Once and Confirm Modes

To toggle between the At Once and Confirm modes, do the following:

1. Press the TAKE button to toggle between the At Once mode (in which the TAKE button is not lit) and the Confirm mode (in which the TAKE button illuminates).  
Actions now require user confirmation and the TAKE button illuminates.
2. Press the illuminated TAKE button to toggle from the Confirm mode back to the At Once mode.  
Actions no longer require user confirmation and the TAKE button no longer illuminates.

### 8.4.2 Confirming a Switching Action

To confirm a switching action (in the Confirm mode), do the following:

1. Press an OUT-IN combination.  
The corresponding 7-segment display blinks. The TAKE button also blinks.
2. Press the blinking TAKE button to confirm the action.  
The corresponding 7-segment display no longer blinks. The TAKE button illuminates.

---

<sup>1</sup> Failure to press the TAKE button within one minute (the Timeout) will abort the action

## 8.5 Storing/Recalling Input/Output Configurations

You can store and recall<sup>1</sup> up to 8 input/output configurations using the 4 OUT buttons and the 4 IN buttons, as Figure 17 illustrates:

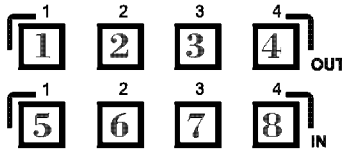

Figure 17: Storing and Recalling using the Input / Output Buttons<sup>2</sup>

### 8.5.1 Storing an Input/Output Configuration

To store the current status in memory, do the following:

1. Press the STO/+ button.  
The STO/+ button blinks.
2. Press one of the 8 IN/OUT buttons (this will be the setup # in which the current status is stored). Press the blinking TAKE button to confirm the action.  
The memory stores the data at that reference.

### 8.5.2 Recalling an Input/Output Configuration

To recall an input/output configuration, do the following:

1. Press the RCL/- button.  
The RCL/- button blinks.
2. Press the appropriate Input / Output button (the button # corresponding to the setup #). That setup configuration will blink in the Audio and Video 7-segment display and the TAKE button, and will only be implemented after pressing the TAKE button.  
The memory recalls the stored data from that reference.

**Tip:** If you cannot remember which of the 8 input/output-configurations is the one that you want, set the VS-44HC to the Confirm mode and manually scan all the input/output configurations until you locate it.

<sup>1</sup> The 8 input/output configurations (or setups) also include the relevant audio-follow-video / breakaway option definition

<sup>2</sup> The gray numbers (1 to 8) in Figure 17 that illustrate the corresponding store/recall configuration numbers, are for the purpose of illustration only and do not appear on the buttons

## 8.6 Setting and Adjusting the Audio Delay Time

You can adjust the audio delay time for OUT 2 to correct lip sync errors so that the audio delay will match the video delay. The delay time can be set and stored separately for each input channel.

To set or adjust the audio delay, do the following:

1. Press the DELAY button on the front panel.  
The DELAY button blinks, the AUDIO 7-segment display shows the delay time in milliseconds and the VIDEO 7-segment display shows the sampling rate in kHz
2. Press the STO/+ and RCL/- buttons to increase or decrease the delay time<sup>1</sup> respectively.
3. Once the delay time is set, press the DELAY button again to accept the delay time value.  
The DELAY button illuminates and the AUDIO 7-segment display goes back to displaying the audio inputs switched to the outputs.

The maximal delay time is set according to the input sampling rate<sup>2</sup>, as described in Table 11:

*Table 11: Maximum Delay Time according to Sampling Rate*

Sampling Rate [kHz]	Maximum Delay Time [msec]
32	999
44	720
48	680
96	340

To cancel the delay time, press the DELAY button once again.  
The DELAY button light turns off.

To reset the delay time to 0 (zero), press and hold the DELAY button for a few seconds.

<sup>1</sup> Press and hold the STO/+ or RCL/- buttons for speedy increase or decrease of the audio delay time respectively

<sup>2</sup> The sampling rate is specified by the source signal and cannot be changed by the switcher. The switcher automatically adjusts the maximum delay time value according to the sampling rate

Table 12 summarizes the way the DELAY button responds:

*Table 12: DELAY Button Response*

When the DELAY button:	Then:
Blinks	You can view the sampling rate and the delay time value, or adjust the delay time
Illuminates	OUT 2 audio delay is on
Is not illuminated	OUT 2 audio delay is off
Is pressed for a few seconds	Delay time resets to 0 (zero)

## 8.7 Locking the Front Panel

To prevent changing the settings accidentally or tampering with the unit via the front panel buttons, lock<sup>1</sup> your **VS-44HC**. Unlocking releases the protection mechanism.

To lock the **VS-44HC**:

- Press the LOCK button  
The LOCK button blinks. After pressing the LOCK button a second time, the front panel is locked. Pressing any other buttons will have no effect

To unlock the **VS-44HC**:

- Press the illuminated LOCK button  
The LOCK button blinks  
When pressing it a second time, the LOCK button no longer illuminates and the front panel unlocks

<sup>1</sup> Nevertheless, even though the front panel is locked you can still operate via Ethernet, RS-232 and RS-485, as well as via the Kramer IR Remote Control Transmitter

## 9 Flash Memory Upgrade

The **VS-44HC** lets you upgrade both microcontrollers:

- The Switcher Microcontroller (see section 9.1)
- The Ethernet Microcontroller (see section 9.2)

### 9.1 Switcher Flash Memory Upgrade

The **VS-44HC** firmware is located in FLASH memory, which lets you upgrade to the latest Kramer firmware version in minutes! The process involves:

- Downloading from the Internet (see section 9.1.1)
- Connecting the PC to the RS-232 port (see section 9.1.2)
- Upgrading Firmware (see section 9.1.3)

#### 9.1.1 Downloading from the Internet

You can download the up-to-date file<sup>1</sup> from the Internet. To do so:

1. Go to our Web site at [www.kramerelectronics.com](http://www.kramerelectronics.com) and download the file: “*FLIP\_VS44HC.zip*” from the Technical Support section.
2. Extract the file: “*FLIP\_VS44HC.zip*” to a folder (for example, C:\Program Files\Kramer Flash).
3. Create a shortcut on your desktop to the file: “*FLIP.EXE*”.

#### 9.1.2 Connecting the PC to the RS-232 Port

Before installing the latest Kramer firmware version on a **VS-44HC** unit, do the following:

1. Connect the RS-232 DB9 rear panel port according to section 7.1.
2. Push the rear panel Flash Upgr. button<sup>2</sup> to **Program** using a small screwdriver.
3. Switch the unit ON.

**Note: this sequence is critical – first push the Flash Upgr. button and then turn on the unit.**

<sup>1</sup> The files indicated in this section are given as an example only. File names are liable to change from time to time

<sup>2</sup> Item 31 in Table 3





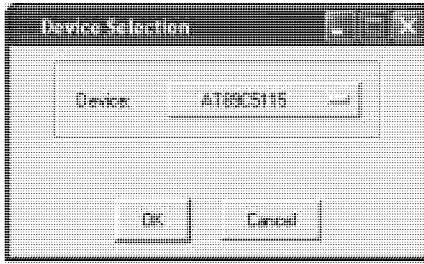

Figure 20: Device Selection Window

4. Click the button next to the name of the device and select from the list: AT89C51RD2:

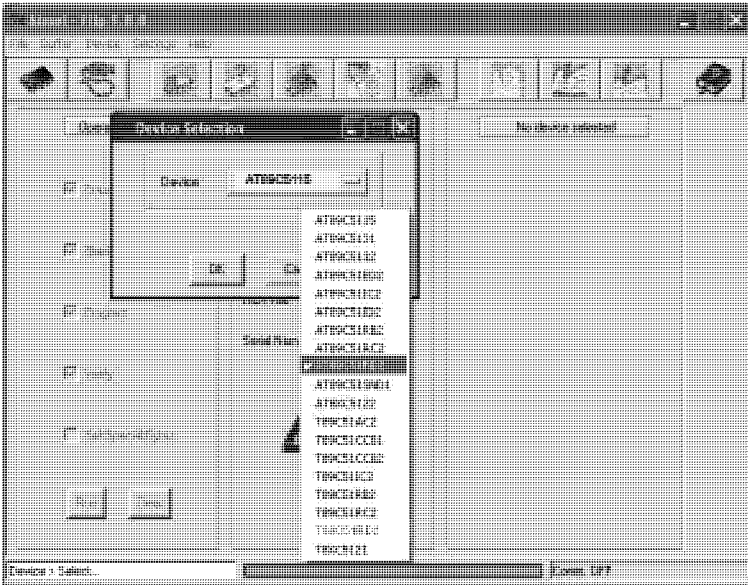

Figure 21: Device Selection window

5. Click OK and select “Load Hex” from the File menu.

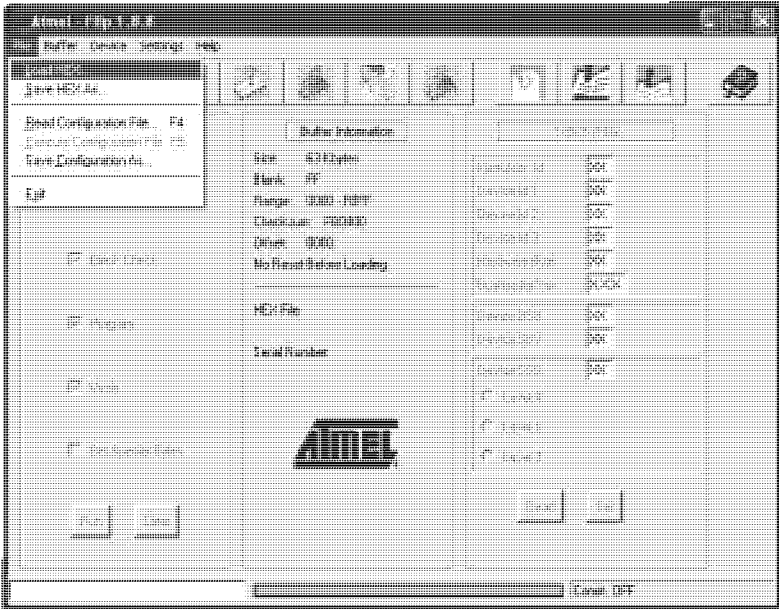

Figure 22: Loading the Hex

6. The Open File window opens. Select the correct HEX file that contains the updated version of the firmware for **VS-44HC** (for example **44M\_VIp2.hex**) and click Open.
7. Press the keyboard shortcut key **F3** (or select the “*Communication / RS232*” command from the *Settings* menu, or press the keys: *Alt SCR*). The “*RS232*” window appears. Change the COM port according to the configuration of your computer and select the 9600 baud rate:

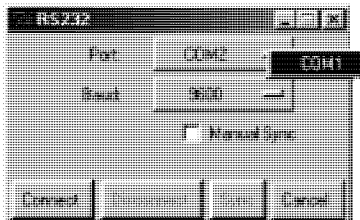

Figure 23: RS-232 Window

8. Click Connect.  
In the “*Atmel – Flip*” window, in the *Operations Flow* column, the *Run* button is active, and the name of the chip appears as the name of the third column: **AT89C51RD2**.

Verify that in the *Buffer Information* column, the “*HEX File: VS44HC.hex*” appears.

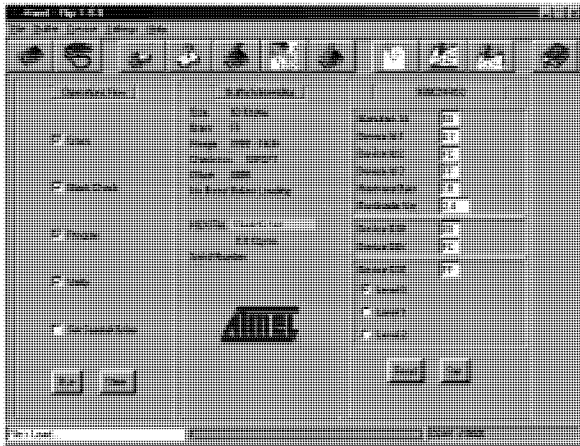

Figure 24: Atmel – Flip Window (Connected)

9. Click *Run*.

After each stage of the operation is completed, the check-box for that stage becomes colored green<sup>1</sup>.

When the operation is completed, all 4 check-boxes will be colored green and the status bar message: *Memory Verify Pass* appears<sup>2</sup>:

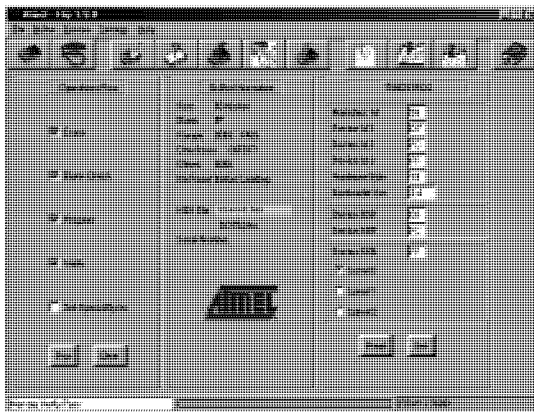

Figure 25: Atmel – Flip Window (Operation Completed)

<sup>1</sup> See also the blue progress indicator on the status bar

<sup>2</sup> If an error message: “Not Finished” shows, click Run again

10. Close the “*Atmel – Flip*” window.
11. Disconnect the power on the **VS-44HC**.
12. If required, disconnect the RS-232 rear panel port on the **VS-44HC** unit from the Null-modem adapter.
13. Release the Flash Upgr. button on the rear panel (Table 3).
14. Connect the power to the **VS-44HC**.  
Upon initialization, the new **VS-44HC** software version shows in the INPUT STATUS 7-segment Display.

## 9.2 Ethernet Flash Memory Upgrade

The **VS-44HC** firmware is located in FLASH memory, which lets you upgrade to the latest Kramer firmware version in minutes!

The process involves:

- Downloading the upgrade package from the Internet
- Connecting the PC to the RS-232 port
- Upgrading the firmware

### 9.2.1 Downloading from the Internet

You can download the up-to-date file<sup>1</sup> from the Internet. To do so:

1. Go to our Web site at <http://www.Kramerelectronics.com> and download the file: “*SetKFRETH11-xx.zip*” from the technical support section.
2. Extract the file “*SetKFRETH11-xx.zip*” package, which includes the KFR-Programmer application setup and the *.s19* firmware file, to a folder (for example, C:\Program Files\KFR Upgrade).
3. Install the KFR-Programmer Application.

### 9.2.2 Connecting the PC to the RS-232 Port

Before installing the latest Kramer Ethernet firmware version on the **VS-44HC**, do the following:

1. Connect the RS-232 DB9 port (COM 1) on the **VS-44HC** to a Null-modem adapter and connect the Null-modem adapter with a 9-wire flat cable to the RS-232 DB9 COM port on your PC.
2. Set the ETH Flash/Normal switch, located on the machine underside, to ETH Flash.
3. Connect the power on your machine.

---

<sup>1</sup> File names are liable to change from time to time

### 9.2.3 Upgrading Firmware

Follow these steps to upgrade the firmware:

1. Double click the KFR-Programmer desktop icon.  
The KFR-Programmer window appears (see Figure 26).

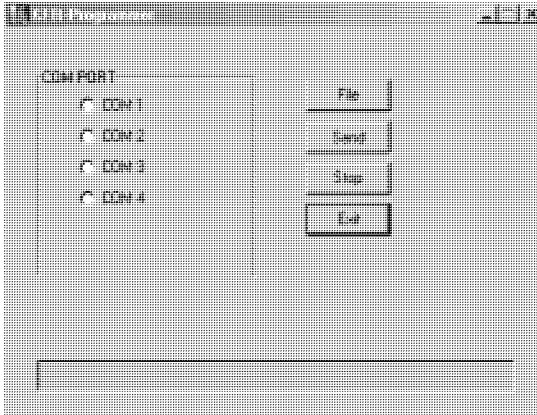

Figure 26: The KFR-Programmer Window

2. Select the required COM Port<sup>1</sup>.
3. Press the File button to select the .s19 firmware file included in the package.
4. Press the Send button to download the file. The Send button lights red.
5. Wait until downloading is completed and the red Send button turns off.
6. Disconnect the power on the **VS-44HC**.
7. Set the ETH Flash/Normal switch, located on the machine underside, to Normal.
8. Connect the power on your machine.

---

<sup>1</sup> To which the VS-44HC is connected on your PC

## 10 Technical Specifications

Table 13 includes the technical specifications:

Table 13: Technical Specifications<sup>1</sup> of the VS-44HC

Video Components	
INPUTS:	4 sets of component video (Y, Pb/Cb, Pr/Cr) 1Vpp, 0.7Vpp, 0.7Vpp / 75Ω on RCA connectors
OUTPUTS:	4 sets of component video (Y, Pb/Cb, Pr/Cr) 1Vpp, 0.7Vpp, 0.7Vpp / 75Ω on RCA connectors
MAX. OUTPUT LEVEL:	2.3Vpp
BANDWIDTH (-3dB):	200MHz, Fully Loaded
DIFF. GAIN:	0.08%
DIFF. PHASE:	0.77 Deg
K-FACTOR:	<0.05%
S/N RATIO:	73dB weighted
CROSSTALK (all hostile):	-53dB @ 5MHz
COUPLING:	DC
Audio Components	
INPUTS:	4 S/PDIF digital audio, on RCA connectors; 1 TOSLINK optical
OUTPUTS:	4 S/PDIF digital audio, on RCA connectors; 1 TOSLINK optical
S/PDIF SAMPLE RATE:	Up to 192kHz
RESOLUTION:	Up to 24 bits
JITTER:	<1.5ns (50Hz to 100kHz) without delay, <3.5ns (50Hz to 100kHz) with delay
MAXIMUM DELAY TIME FOR CHANNEL 2:	32kHz – 999ms; 44.1kHz – 720ms; 48kHz – 680ms; 96kHz – 340ms
DELAY RESOLUTION:	1ms
General	
CONTROLS:	Front panel buttons, Ethernet, RS-232, RS-485, IR remote control
POWER SOURCE:	100-240 VAC, 50/60 Hz; 90mA switching power supply
DIMENSIONS:	19-inch (W), 7-inch (D) 1U (H) rack-mountable
WEIGHT:	2.7 kg (6 lbs.) approx.
ACCESSORIES:	Power cord, Null modem adapter, Windows®-based Kramer control software, Windows®-based Ethernet Configuration Manager and Virtual Serial Port Manager, Infra-red remote control transmitter

<sup>1</sup> Specifications are subject to change without notice

## 11 Table of Hex Codes for Serial Communication

Sections 11.1 and 11.2 contain the tables of hex codes for switching and setting the delay time, respectively.

### 11.1 Hex Codes for Switching

Table 14 lists the Hex values for a single machine (machine # 1):

Table 14: VS-44HC Hex Codes for Switching via RS-232/RS-485

	Switching Video Channels				Switching Audio Channels			
	OUT 1	OUT 2	OUT 3	OUT 4	OUT 1	OUT 2	OUT 3	OUT 4
IN 1	01	01	01	01	02	02	02	02
	81	81	81	81	81	81	81	81
	81	82	83	84	81	82	83	84
	81	81	81	81	81	81	81	81
IN 2	01	01	01	01	02	02	02	02
	82	82	82	82	82	82	82	82
	81	82	83	84	81	82	83	84
	81	81	81	81	81	81	81	81
IN 3	01	01	01	01	02	02	02	02
	83	83	83	83	83	83	83	83
	81	82	83	84	81	82	83	84
	81	81	81	81	81	81	81	81
IN 4	01	01	01	01	02	02	02	02
	84	84	84	84	84	84	84	84
	81	82	83	84	81	82	83	84
	81	81	81	81	81	81	81	81

### 11.2 VS-44HC Hex Codes for Setting the Audio Delay Time

To set the audio delay time, use command 22 (set audio parameter) in the following way:

- Byte 1 should be 22 (16H)
- Byte 2 should be 127 (80H) plus input Channel number (from 1 to 4)
- Byte 3 should be 127 (80H) plus delay value in milliseconds (from 1 to 127)
- Byte 4 should be 127 (80H) plus machine number (from 1 to 15)

Table 15 describes several examples for the hex codes used to set the delay time:

Table 15: VS-44HC Hex Codes for Setting the Audio Delay Time

Delay Time [msec]	For	Command			
0	IN 1	16	81	80	81
5	IN 2	16	82	85	81
64	IN 3	16	83	84	81
127	IN 4	16	84	FF	81



For delay times exceeding 127ms, you need to send two commands (eight bytes).

The first command includes the most significant bits:

- Byte 1 should be 63 (7FH)
- Byte 2 should be 127 (80H) plus Most Significant bits of required delay
- Byte 3 should be 127 (80H)
- Byte 4 should be 127 (80H) plus machine number (from 1 up to 15)

The second command includes the less significant bits as described previously for command 22.

Table 16 describes hex code examples for setting increased audio delay times:

*Table 16: VS-44HC Hex Codes for increasing the Audio Delay Time*

Delay Time for IN 1 [msec]	Command			
128	7F	80	81	81
	16	81	80	81
130	7F	80	81	81
	16	81	82	81
200	7F	80	81	81
	16	81	C8	81
680	7F	80	85	81
	16	81	A8	81

To increase, for example, the IN 1 audio delay time by 1msec, the hex code would be:

18	82	8C	81
----	----	----	----

To decrease, for example, the IN 4 audio delay time by 1msec, the hex code would be:

18	84	8D	81
----	----	----	----

## 12 Kramer Protocol 2000<sup>1</sup>

The **VS-44HC** is compatible with Kramer's Protocol 2000 (version 0.46) (below). This RS-232/RS-485 communication protocol uses four bytes of information as defined below. For RS-232, a null-modem connection between the machine and controller is used. The default data rate is 9600 baud, with no parity, 8 data bits and 1 stop bit.

Table 17: Protocol Definitions

MSB							LSB	
	DESTINATION		INSTRUCTION					
0	D	N5	N4	N3	N2	N1	N0	
7	6	5	4	3	2	1	0	
1st byte								
	INPUT							
1	I6	I5	I4	I3	I2	I1	I0	
7	6	5	4	3	2	1	0	
2nd byte								
	OUTPUT							
1	O6	O5	O4	O3	O2	O1	O0	
7	6	5	4	3	2	1	0	
3rd byte								
	MACHINE NUMBER							
1	OVR	X	M4	M3	M2	M1	M0	
7	6	5	4	3	2	1	0	
4th byte								

1<sup>st</sup> BYTE: Bit 7 – Defined as 0.

D – “DESTINATION”: 0 - for sending information to the switchers (from the PC);

1 - for sending to the PC (from the switcher).

N5...N0 – “INSTRUCTION”

The function that is to be performed by the switcher(s) is defined by the INSTRUCTION (6 bits). Similarly, if a function is performed via the machine's keyboard, then these bits are set with the INSTRUCTION NO., which was performed. The instruction codes are defined according to the table below (INSTRUCTION NO. is the value to be set for N5...N0).

2<sup>nd</sup> BYTE: Bit 7 – Defined as 1.

I6...I0 – “INPUT”.

When switching (ie. instruction codes 1 and 2), the INPUT (7 bits) is set as the input number which is to be switched. Similarly, if switching is done via the machine's front-panel, then these bits are set with the INPUT NUMBER which was switched. For other operations, these bits are defined according to the table.

3<sup>rd</sup> BYTE: Bit 7 – Defined as 1.

O6...O0 – “OUTPUT”.

When switching (ie. instruction codes 1 and 2), the OUTPUT (7 bits) is set as the output number which is to be switched. Similarly, if switching is done via the machine's front-panel, then these bits are set with the OUTPUT NUMBER which was switched. For other operations, these bits are defined according to the table.

4<sup>th</sup> BYTE: Bit 7 – Defined as 1.

Bit 5 – Don't care.

OVR – Machine number override.

M4...M0 – MACHINE NUMBER.

Used to address machines in a system via their machine numbers. When several machines are controlled from a single serial port, they are usually configured together with each machine having an individual machine number. If the OVR bit is set, then all machine numbers will accept (implement) the command, and the addressed machine will reply.

For a single machine controlled via the serial port, always set M4...M0 = 1, and make sure that the machine itself is configured as MACHINE NUMBER = 1.

<sup>1</sup> You can download our user-friendly “Software for Calculating Hex Codes for Protocol 2000” from our Web site: <http://www.kramerelectronics.com>

Table 18: Instruction Codes for Protocol 2000

Note: All values in the table are decimal, unless otherwise stated.

INSTRUCTION		DEFINITION FOR SPECIFIC INSTRUCTION		NOTE
#	DESCRIPTION	INPUT	OUTPUT	
0	RESET VIDEO	0	0	1
1	SWITCH VIDEO	Set equal to video input which is to be switched (0 = disconnect)	Set equal to video output which is to be switched (0 = to all the outputs)	2, 15
2	SWITCH AUDIO	Set equal to audio input which is to be switched (0 = disconnect)	Set equal to audio output which is to be switched (0 = to all the outputs)	2
3	STORE VIDEO STATUS	Set as SETUP #	0 - to store 1 - to delete	2, 3, 15
4	RECALL VIDEO STATUS	Set as SETUP #	0	2, 3, 15
5	REQUEST STATUS OF A VIDEO OUTPUT	Set as SETUP #	Equal to output number whose status is reqd	4, 3
6	REQUEST STATUS OF AN AUDIO OUTPUT	Set as SETUP #	Equal to output number whose status is reqd	4, 3
7	VIS SOURCE	Set as input # when OUTPUT byte = 6; OR set as output # when OUTPUT byte = 7; OR set as blank period (in steps of 25ms) when OUTPUT byte = 32; OR set = 0. *****	0 - No VIS (immediate) 1 - Input # 1 2 - External digital sync 3 - External analog sync 4 - Dynamic sync 5 - Inter-machine sync 6 - Input # (INPUT byte) 7 - Output # (INPUT byte) 8 - User-defined sync 32 - RGBHV seamless switching 64 - Set for delayed switch 65 - Execute delayed switch 66 - Cancel delayed switch setting	2, 5, 17, 18
8	BREAKAWAY SETTING	0	0 - audio-follow-video 1 - audio breakaway	2
		1	0 - FOLLOW mode 1 - Normal mode	15
9	VIDEO / AUDIO TYPE SETTING	0 - for video	0 - CV            4 - SDI 1 - YC            5 - CV+YC 2 - YUV          6 - VGA scaler 3 - RGBS        7 - DVI	2
		1 - for audio	O0=0 – Unbalanced audio O0=1 – Balanced audio O1=0 – Digital audio O1=1 – Analog audio O4=0, O3=0, O2=0-Mono O4=0, O3=0, O2=1-Stereo	
		2 - for VGA and DVI	1 - 640X480 2 - 800X600 3 - 1024X768	
10	REQUEST VIS SETTING	Set as SETUP #, or set to 126 or 127 to request if machine has this function	0 - VIS source 1 - Input # or output # of source 2 - Vertical sync freq (Hz)	3, 4, 6, 7
11	REQUEST BREAKAWAY SETTING	Set as SETUP #, or set to 126 or 127 to request if machine has this function	0 - Request audio breakaway setting 1 - Request "FOLLOW" setting	3, 4, 6, 15
12	REQUEST VIDEO / AUDIO TYPE SETTING	Set as SETUP #, or set to 126 or 127 to request if machine has this function	0 - for video 1 - for audio 2 - for VGA	3, 4, 6
13	SET HIGHEST MACHINE ADDRESS	0 - for video 1 - for audio	Set equal to highest machine address	2
14	REQUEST HIGHEST MACHINE ADDRESS	0 - for video 1 - for audio	0	4
15	REQUEST WHETHER SETUP IS DEFINED / VALID INPUT IS DETECTED	SETUP # or Input #	0 - for checking if setup is defined 1 - for checking if input is valid	8

Kramer Protocol 2000

INSTRUCTION		DEFINITION FOR SPECIFIC INSTRUCTION		NOTE
#	DESCRIPTION	INPUT	OUTPUT	
16	ERROR / BUSY	For invalid / valid input (i.e. OUTPUT byte = 4 or OUTPUT byte = 5), this byte is set as the input #	0 - error 1 - invalid instruction 2 - out of range 3 - machine busy 4 - invalid input 5 - valid input	9, 25
17	RESERVED	----	----	10
18	RESET AUDIO	0	0	1
19	STORE AUDIO STATUS	Set as SETUP #	0 - to store 1 - to delete	2, 3
20	RECALL AUDIO STATUS	Set as SETUP #	0	2, 3
21	SET VIDEO PARAMETER	Equal to input / output number whose video parameter is to be set (0 = all)	Set as parameter value	2, 11, 24
22	SET AUDIO PARAMETER	Equal to input / output number whose gain is to be set (0 = all)	Set as parameter value	2, 11, 24
23	INCREASE / DECREASE VIDEO PARAMETER	Equal to input / output number whose video parameter is to be increased / decreased (0 = all)	0 - increase video gain 1 - decrease video gain 2 - increase contrast 3 - decrease contrast 4 - increase brightness 5 - decrease brightness 6 - increase color 7 - decrease color 8 - increase hue 9 - decrease hue 16 - increase H-phase 17 - decrease H-phase 18 - increase V-position 19 - decrease V-position	24
24	INCREASE / DECREASE AUDIO PARAMETER	Equal to input / output number whose parameter is to be increased / decreased (0 = all)	0 - increase output 1 - decrease output 2 - increase left output 3 - decrease left output 4 - increase right output 5 - decrease right output 6 - increase input 7 - decrease input 8 - increase left input 9 - decrease left input 10 - increase right input 11 - decrease right input	24
25	REQUEST AUDIO PARAMETER	Equal to input / output number whose parameter is requested	0	6, 24
26	REQUEST VIDEO PARAMETER	Equal to input / output number whose video parameter is requested	0	6, 24
30	LOCK FRONT PANEL	0 - Panel unlocked 1 - Panel locked	0	2
31	REQUEST WHETHER PANEL IS LOCKED	0	0	16
32 to 35	RESERVED	----	----	10
40	DIRECT MEMORY SAVE	Memory address	Data	20
42	AUDIO PARAMETER SETTINGS FOR INSTRUCTIONS 22, 24, 25	INPUT Bit: 10 - 0=input; 1=output 11 - Left 12 - Right	0 - Gain 1 - Bass 2 - Treble 3 - Midrange	24

#	INSTRUCTION DESCRIPTION	DEFINITION FOR SPECIFIC INSTRUCTION		NOTE
		INPUT	OUTPUT	
43	VIDEO PARAMETER SETTINGS FOR INSTRUCTIONS 21, 23, 26	1 - Input 2 - Output	0 - video gain 1 - contrast 2 - brightness 3 - color 4 - hue 5 - H-phase 6 - V-position	24
56	CHANGE TO ASCII	0	1 - SVS protocol 2 - Generic protocol	19
57	SET AUTO-SAVE	13 - no save 14 - auto-save	0	12, 2
58	EXECUTE LOADED DATA	Set as 0, or as SETUP #.	1-Take 2-Cancel	22, 3
59	LOAD VIDEO DATA	Set equal to video input (0 = disconnect) ----- (127 = load SETUP #)	Set equal to video output (0 = to all the outputs) ----- or SETUP #	22, 23
60	LOAD AUDIO DATA	Set equal to audio input (0 = disconnect) ----- (127 = load SETUP #)	Set equal to audio output (0 = to all the outputs) ----- or SETUP #	22, 23
61	IDENTIFY MACHINE	1 - video machine name 2 - audio machine name 3 - video software version 4 - audio software version 5 - RS422 controller name 6 - RS422 controller version 7 - remote control name 8 - remote software version 9 - Protocol 2000 revision	0 - Request first 4 digits 1 - Request first suffix 2 - Request second suffix 3 - Request third suffix 10 - Request first prefix 11 - Request second prefix 12 - Request third prefix	13
62	DEFINE MACHINE	1 - number of inputs 2 - number of outputs 3 - number of setups	1 - for video 2 - for audio 3 - for SDI 4 - for remote panel 5 - for RS-422 controller	14
63	EXTENDED DATA	7 MSBs for INPUT data	7 MSBs for OUTPUT data	20

NOTES on the above table:

**NOTE 1** - When the master switcher is reset, (e.g. when it is turned on), the reset code is sent to the PC. If this code is sent to the switchers, it will reset according to the present power-down settings.

**NOTE 2** - These are bi-directional definitions. That is, if the switcher receives the code, it will perform the instruction; and if the instruction is performed (due to a keystroke operation on the front panel), then these codes are sent. For example, if the HEX code

01            85            88            83

was sent from the PC, then the switcher (machine 3) will switch input 5 to output 8. If the user switched input 1 to output 7 via the front panel keypad, then the switcher will send HEX codes:

41            81            87            83

to the PC.

When the PC sends one of the commands in this group to the switcher, then, if the instruction is valid, the switcher replies by sending to the PC the same four bytes that it was sent (except for the first byte, where the DESTINATION bit is set high).

**NOTE 3** - SETUP # 0 is the present setting. SETUP # 1 and higher are the settings saved in the switcher's memory, (i.e. those used for Store and Recall).

**NOTE 4** - The reply to a "REQUEST" instruction is as follows: the same instruction and INPUT codes as were sent are returned, and the OUTPUT is assigned the value of the requested parameter. The replies to instructions 10 and 11 are as per the definitions in instructions 7 and 8 respectively. For example, if the present status of machine number 5 is breakaway setting, then the reply to the HEX code

0B            80            80            85

would be HEX codes

4B            80            81            85

**NOTE 5** - For the OUTPUT byte set as 6, the VIS source is the input selected using the OUTPUT byte. Similarly, for the OUTPUT byte set as 7, the VIS source is the output selected using the OUTPUT byte. Note also, that on some machines the sync source is not software selectable, but is selected using switches, jumpers, etc!

**NOTE 6** – If INPUT is set to 127 for these instructions, then, if the function is defined on this machine, it replies with OUTPUT=1. If the function is not defined, then the machine replies with OUTPUT=0, or with an error (invalid instruction code).

If the INPUT is set to 126 for these instructions, then, if possible, the machine will return the current setting of this function, even for the case that the function is not defined. For example, for a video switcher which always switches during the VIS of input #1, (and its VIS setting cannot be programmed otherwise), the reply to the HEX code

0A FE 80 81 (ie. request VIS setting, with INPUT set as 126<sub>dec</sub>)

would be HEX codes

4A FE 81 81 (ie. VIS setting = 1, which is defined as VIS from input #1).

**NOTE 7** – Setting OUTPUT to 0 will return the VIS source setting as defined in instruction #7. Setting to 1 will return the input # or output # of the sync source (for the case where the VIS source is set as 6 or as 7 in instruction #7). Setting to 2 returns the vertical sync frequency (0 for no input sync, 50 for PAL, 60 for NTSC, 127 for error).

**NOTE 8** - The reply is as in TYPE 3 above, except that here the OUTPUT is assigned with the value 0 if the setup is not defined / no valid input is detected; or 1 if it is defined / valid input is detected.

**NOTE 9** - An error code is returned to the PC if an invalid instruction code was sent to the switcher, or if a parameter associated with the instruction is out of range (e.g. trying to save to a setup greater than the highest one, or trying to switch an input or output greater than the highest one defined). This code is also returned to the PC if an RS-232 instruction is sent while the machine is being programmed via the front panel. Reception of this code by the switcher is not valid.

**NOTE 10** – This code is reserved for internal use.

**NOTE 11** – For machines where the video and / or audio gain is programmable.

**NOTE 12** - Under normal conditions, the machine's present status is saved each time a change is made. The "power-down" save (auto-save) may be disabled using this code. Note that whenever the machine is turned on, the auto-save function is set.

**NOTE 13** - This is a request to identify the switcher/s in the system. If the OUTPUT is set as 0, and the INPUT is set as 1, 2, 5 or 7, the machine will send its name. The reply is the decimal value of the INPUT and OUTPUT. For example, for a 2216, the reply to the request to send the audio machine name would be (HEX codes):

7D 96 90 81 (i.e. 128<sub>dec</sub>+22<sub>dec</sub> for 2<sup>nd</sup> byte, and 128<sub>dec</sub>+16<sub>dec</sub> for 3<sup>rd</sup> byte).

If the request for identification is sent with the INPUT set as 3 or 4, the appropriate machine will send its software version number. Again, the reply would be the decimal value of the INPUT and OUTPUT - the INPUT representing the number in front of the decimal point, and the OUTPUT representing the number after it. For example, for version 3.5, the reply to the request to send the version number would be (HEX codes):

7D 83 85 81 (i.e. 128<sub>dec</sub>+3<sub>dec</sub> for 2<sup>nd</sup> byte, 128<sub>dec</sub>+5<sub>dec</sub> for 3<sup>rd</sup> byte).

If the OUTPUT is set as 1, then the ASCII coding of the lettering following the machine's name is sent. For example, for the VS-7588YC, the reply to the request to send the first suffix would be (HEX codes):

7D D9 C3 81 (i.e. 128<sub>dec</sub>+ASCII for "Y"; 128<sub>dec</sub>+ASCII for "C").

**NOTE 14** - The number of inputs and outputs refers to the specific machine which is being addressed, *not* to the system. For example, if six 16X16 matrices are configured to make a 48X32 system (48 inputs, 32 outputs), the reply to the HEX code

3E 82 81 82 (ie. request the number of outputs)

would be HEX codes

7E 82 90 82

ie. 16 outputs

**NOTE 15** – When the OVR bit (4<sup>th</sup> byte) is set, then the "video" commands have universal meaning. For example, instruction 1 (SWITCH VIDEO) will cause all units (including audio, data, etc.) to switch. Similarly, if a machine is in "FOLLOW" mode, it will perform any "video" instruction.

**NOTE 16** - The reply to the "REQUEST WHETHER PANEL IS LOCKED" is as in NOTE 4 above, except that here the OUTPUT is assigned with the value 0 if the panel is unlocked, or 1 if it is locked.

**NOTE 17** – For clean switching of RGBHV video, the "seamless switching" option may be used. The blanking period for the transition of the RGB sources may be set in this case, in steps of 25 milliseconds.

For example, to set for 350ms blanking time (14 steps), send HEX codes

07 8E A0 81

**NOTE 18** – Delayed execution allows switching after a delay dictated by RS-232. To do this, the user sends instruction 7 with the "Set for delayed switch" option (64<sub>dec</sub>) before sending the switch command (instruction 1) or pressing via front panel. The switch is not executed (unless timed-out) until the "Execute delayed switch" code is sent, or the "Set for delayed switch"

code is sent again. (The mode is automatically cancelled after implementation of the switch if the “execute” command is used).

For example, to connect input 4 to output 3 after a delay, send HEX codes

07	80	C0	81	(set for delayed switch)
01	84	83	81	(switch code)

then, after the required delay, send HEX codes

07	80	C1	81	(execute delayed switch)
----	----	----	----	--------------------------

to implement the switch.

**NOTE 19** – After this instruction is sent, the unit will respond to the ASCII command set defined by the OUTPUT byte. The ASCII command to operate with the HEX command set must be sent in order to return to working with HEX codes.

**NOTE 20** – When data (ie. the INPUT and/or OUTPUT bytes) of more than 7 bits is required, this instruction is sent before sending the instruction needing the additional bits. The data in this instruction then becomes the Most Significant Bits of that next instruction. For example, to set the audio gain (instruction 22) of output 3 to  $681_{dec}$  ( $2A9_{hex}$ ), you would first send HEX codes

	3F	80	85	81
--	----	----	----	----

and then send HEX codes

	16	83	A9	81.
--	----	----	----	-----

To set the audio gain of output 6 to  $10013_{dec}$  ( $271D_{hex}$ ), first send HEX codes

	3F	80	CE	81
--	----	----	----	----

followed by HEX codes

	16	86	9D	81.
--	----	----	----	-----

**NOTE 21** – To store data in the non-volatile memory of the unit, eg. the EEPROM for saving SETUPS. The EEPROM address is sent using the INPUT byte, and the data to be stored is sent using the OUTPUT byte. To use this instruction, it is necessary to understand the memory map, and memory structure of the particular machine.

**NOTE 22** – Instruction 59 and instruction 60 load data for sending to the crosspoint switcher (or for storing in a SETUP), ie. the data is “lined-up” to be executed later. Instruction 58 executes the loaded data.

**NOTE 23** – If the INPUT byte is set as  $127_{dec}$ , then the data stored in a SETUP is loaded. The SETUP # is in the OUTPUT byte.

**NOTE 24** – Further information needed in instructions 21, 22, 25 and 26, is sent using instruction 42 – which is sent prior to the instruction. For example, to request the audio gain value of right input # 9, send hex codes

	2A	84	80	81
--	----	----	----	----

and then send HEX codes

	19	89	81	81.
--	----	----	----	-----

**NOTE 25** – For units which detect the validity of the video inputs, Instruction 16 will be sent whenever the unit detects a change in the state of an input (in real-time).

For example, if input 3 is detected as invalid, the unit will send the HEX codes

	10	83	84	81
--	----	----	----	----

If input 7 is detected as valid, then the unit will send HEX codes

	10	87	85	81.
--	----	----	----	-----

---

## LIMITED WARRANTY

Kramer Electronics (hereafter *Kramer*) warrants this product free from defects in material and workmanship under the following terms.

### HOW LONG IS THE WARRANTY

Labor and parts are warranted for seven years from the date of the first customer purchase.

### WHO IS PROTECTED?

Only the first purchase customer may enforce this warranty.

### WHAT IS COVERED AND WHAT IS NOT COVERED

Except as below, this warranty covers all defects in material or workmanship in this product. The following are not covered by the warranty:

1. Any product which is not distributed by Kramer, or which is not purchased from an authorized Kramer dealer. If you are uncertain as to whether a dealer is authorized, please contact Kramer at one of the agents listed in the Web site [www.kramerelectronics.com](http://www.kramerelectronics.com).
2. Any product, on which the serial number has been defaced, modified or removed.
3. Damage, deterioration or malfunction resulting from:
  - i) Accident, misuse, abuse, neglect, fire, water, lightning or other acts of nature
  - ii) Product modification, or failure to follow instructions supplied with the product
  - iii) Repair or attempted repair by anyone not authorized by Kramer
  - iv) Any shipment of the product (claims must be presented to the carrier)
  - v) Removal or installation of the product
  - vi) Any other cause, which does not relate to a product defect
  - vii) Cartons, equipment enclosures, cables or accessories used in conjunction with the product

### WHAT WE WILL PAY FOR AND WHAT WE WILL NOT PAY FOR

We will pay labor and material expenses for covered items. We will not pay for the following:

1. Removal or installations charges.
2. Costs of initial technical adjustments (set-up), including adjustment of user controls or programming. These costs are the responsibility of the Kramer dealer from whom the product was purchased.
3. Shipping charges.

### HOW YOU CAN GET WARRANTY SERVICE

1. To obtain service on you product, you must take or ship it prepaid to any authorized Kramer service center.
2. Whenever warranty service is required, the original dated invoice (or a copy) must be presented as proof of warranty coverage, and should be included in any shipment of the product. Please also include in any mailing a contact name, company, address, and a description of the problem(s).
3. For the name of the nearest Kramer authorized service center, consult your authorized dealer.

### LIMITATION OF IMPLIED WARRANTIES

All implied warranties, including warranties of merchantability and fitness for a particular purpose, are limited in duration to the length of this warranty.

### EXCLUSION OF DAMAGES

The liability of Kramer for any effective products is limited to the repair or replacement of the product at our option. Kramer shall not be liable for:

1. Damage to other property caused by defects in this product, damages based upon inconvenience, loss of use of the product, loss of time, commercial loss; or;
2. Any other damages, whether incidental, consequential or otherwise. Some countries may not allow limitations on how long an implied warranty lasts and/or do not allow the exclusion or limitation of incidental or consequential damages, so the above limitations and exclusions may not apply to you.

This warranty gives you specific legal rights, and you may also have other rights, which vary from place to place.

**NOTE:** All products returned to Kramer for service must have prior approval. This may be obtained from your dealer.

This equipment has been tested to determine compliance with the requirements of:

- EN-50081: "Electromagnetic compatibility (EMC);  
generic emission standard.  
Part 1: Residential, commercial and light industry"
- EN-50082: "Electromagnetic compatibility (EMC) generic immunity standard.  
Part 1: Residential, commercial and light industry environment".
- CFR-47:  
FCC Rules and Regulations:  
Part 15: "Radio frequency devices  
Subpart B – Unintentional radiators"

### CAUTION!

- ☒ Servicing the machines can only be done by an authorized Kramer technician. Any user who makes changes or modifications to the unit without the expressed approval of the manufacturer will void user authority to operate the equipment.
- ☒ Use the supplied DC power supply to feed power to the machine.
- ☒ Please use recommended interconnection cables to connect the machine to other components.





---

For the latest information on our products and a list of Kramer distributors, visit our Web site: [www.kramerelectronics.com](http://www.kramerelectronics.com), where updates to this user manual may be found. We welcome your questions, comments and feedback.

 <p><b>Caution</b></p>	<p><b>Safety Warning:</b> Disconnect the unit from the power supply before opening/servicing.</p>
---	---



---

**Kramer Electronics, Ltd.**  
Web site: [www.kramerelectronics.com](http://www.kramerelectronics.com)  
E-mail: [info@kramereel.com](mailto:info@kramereel.com)  
P/N: 2900-000131 REV 1