

Kramer Electronics, Ltd.



USER MANUAL

Model:

VP-23DS

Presentation Switcher / Scaler

Contents

| | | |
|-----------|--|-----------|
| 1 | Introduction | 1 |
| 2 | Getting Started | 1 |
| 2.1 | Quick Start | 1 |
| 3 | Overview | 3 |
| 4 | Your VP-23DS Presentation Switcher / Scaler | 3 |
| 5 | Installing the VP-23DS on a Rack | 7 |
| 6 | Connecting the VP-23DS Presentation Switcher / Scaler | 8 |
| 6.1 | Connecting a PC | 10 |
| 7 | Operating the VP-23DS Presentation Switcher / Scaler | 11 |
| 7.1 | Operating your Switcher | 11 |
| 7.2 | Operating the Scaler Section | 12 |
| 8 | Flash Memory Upgrade | 13 |
| 8.1 | Downloading from the Internet | 13 |
| 8.2 | Connecting the PC to the RS-232 Port | 13 |
| 8.3 | Upgrading Firmware | 13 |
| 9 | Technical Specifications | 19 |
| 10 | Hex Tables | 20 |
| 10.1 | Audio Gain Control Hex Tables | 20 |
| 11 | VP-23DS Communication Protocol | 21 |

Figures

| | | |
|------------|---|----|
| Figure 1: | VP-23DS Presentation Switcher / Scaler | 4 |
| Figure 2: | Connecting the VP-23DS Presentation Switcher / Scaler | 9 |
| Figure 3: | Connecting a PC without using a Null-modem Adapter | 10 |
| Figure 4: | Setting the DIP to Flash Program | 13 |
| Figure 5: | Splash Screen | 14 |
| Figure 6: | Atmel – Flip Window | 14 |
| Figure 7: | Device Selection Window | 15 |
| Figure 8: | Selecting the Device from the Selection Window | 15 |
| Figure 9: | Loading the Hex | 16 |
| Figure 10: | RS-232 Window | 16 |
| Figure 11: | Atmel – Flip Window (Connected) | 17 |
| Figure 12: | Atmel – Flip Window (Operation Completed) | 18 |
| Figure 13: | Setting the DIP to Normal | 18 |

Tables

| | |
|--|----|
| Table 1: Front Panel VP-23DS Presentation Switcher / Scaler Features | 5 |
| Table 2: Rear Panel VP-23DS Presentation Switcher / Scaler Features | 6 |
| Table 3: Technical Specifications of the VP-23DS Presentation Switcher | 19 |
| Table 4: VP-23DS Hex Table | 20 |
| Table 5: VP-23DS Master Audio Selector Hex Table | 20 |
| Table 6: Set the Relative Audio Output | 20 |
| Table 7: Increase or Decrease the Audio Output Gain by One Step | 20 |
| Table 8: Protocol Definitions | 21 |
| Table 9: Instruction Codes | 22 |

1 Introduction

Welcome to Kramer Electronics (since 1981): a world of unique, creative and affordable solutions to the infinite range of problems that confront the video, audio and presentation professional on a daily basis. In recent years, we have redesigned and upgraded most of our line, making the best even better! Our 500-plus different models now appear in 8 Groups¹, which are clearly defined by function.

Congratulations on purchasing your Kramer **VP-23DS** *Presentation Switcher / Scaler*. This product is ideal for the following typical applications:

- Presentation and conference room systems, board rooms and auditoriums
- Production studios
- Rental and staging

The package includes the following items:

- **VP-23DS** *Presentation Switcher / Scaler*
- Power cord and Null-modem adapter
- Windows®-based Kramer control software²
- This user manual³

2 Getting Started

We recommend that you:

- Unpack the equipment carefully and save the original box and packaging materials for possible future shipment
- Review the contents of this user manual
- Use Kramer high performance high resolution cables⁴

2.1 Quick Start

This quick start chart summarizes the basic setup and operation steps.

1 GROUP 1: Distribution Amplifiers; GROUP 2: Video and Audio Switchers, Matrix Switchers and Controllers; GROUP 3: Video, Audio, VGA/XGA Processors; GROUP 4: Interfaces and Sync Processors; GROUP 5: Twisted Pair Interfaces; GROUP 6: Accessories and Rack Adapters; GROUP 7: Scan Converters and Scalers; and GROUP 8: Cables and Connectors

2 Downloadable from our Web site at <http://www.kramerelectronics.com>

3 Download up-to-date Kramer user manuals from our Web site at <http://www.kramerelectronics.com>

4 The complete list of Kramer cables is on our Web site at <http://www.kramerelectronics.com>

Step 1: Mount the machine - see section 5

Mount the machine in a rack or stick the 4 rubber feet to the underside

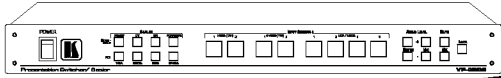

Step 2: Connect the inputs and outputs - see section 6

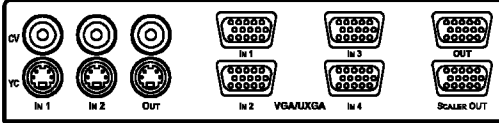

Connect the video inputs and outputs, as well as the SCALER output

Connect the audio inputs and output

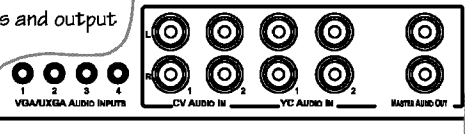

If required, connect an RS-232 optional Control Port

Step 3: Turn the power ON

Step 4: Set the machine - see section 7

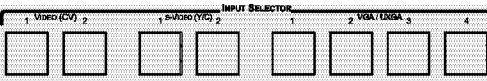

Press a button to select an input on each switcher group (CV, s-Video, and/or VGA/UXGA) to route to the appropriate output. The selected input buttons illuminate.

Press to connect / disconnect the audio inputs from the Master output. This lets you output the microphone only.

Press to lock / unlock the front panel buttons.

Press FOLLOW to select the scaler inputs (CV, Y/C or VGA/UXGA).

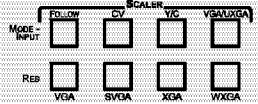

Select the resolution (VGA, SVGA, XGA or WXGA).

Adjust the MASTER Volume: Press + (increase) or - (decrease) buttons to adjust the audio signal level.

Adjust the MIC Volume: Press + (increase) or - (decrease) buttons to adjust the MIC signal level.

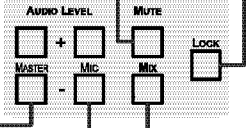

Press to toggle mixing the master audio output with / without the microphone.

Step 5: Operate the machine - see section 7

Operate via the front panel buttons and RS-232

3 Overview

The Kramer **VP-23DS** is a high quality presentation switcher / Scaler designed for a wide variety of presentation and multimedia applications. The **VP-23DS** includes three independently controlled switcher groups that combine the functions of a 2x1 switcher for composite video, a 2x1 switcher for s-Video, and a 4x1 switcher for computer graphics VGA/UXGA type signals. Each video input has its own unbalanced stereo audio input. There is also an independent unbalanced stereo master audio output, which can select a signal from any of the eight audio inputs.

The **VP-23DS** features an additional Scaler output at which the selected video signal (composite or s-Video) is converted to a VGA output (resolution can be scaled up to WXGA).

In addition, the **VP-23DS**:

- Includes eight input selector buttons, control buttons for the master audio output level, microphone level, as well as buttons for selecting the Scaler mode and the Scaler resolution
- Features a FOLLOW button to toggle between the follow and breakaway mode
- Has a LOCK button to prevent unintentional tampering with the front panel buttons
- Is designed so that each switcher group can be controlled independently from the other sections
- Lets you insert an additional microphone channel by mixing with the master output signal or by muting the master output signal

The **VP-23DS** can be controlled via the front panel buttons or by RS-232 serial commands transmitted by a touch screen system, PC, or other serial controller. It is housed in a 19" 1U rack mountable enclosure, with rack "ears" included, and is fed from a 100-240 VAC universal switching power supply.

To achieve the best performance:

- Connect only good quality connection cables, thus avoiding interference, deterioration in signal quality due to poor matching, and elevated noise-levels (often associated with low quality cables)
- Avoid interference from neighboring electrical appliances and position your Kramer **VP-23DS** away from moisture, excessive sunlight and dust

4 Your VP-23DS Presentation Switcher / Scaler

Figure 1 illustrates the front and rear panels of the **VP-23DS**. Tables 1 and 2 define the front and rear panels of the **VP-23DS**, respectively.

Your VP-23DS Presentation Switcher / Scaler

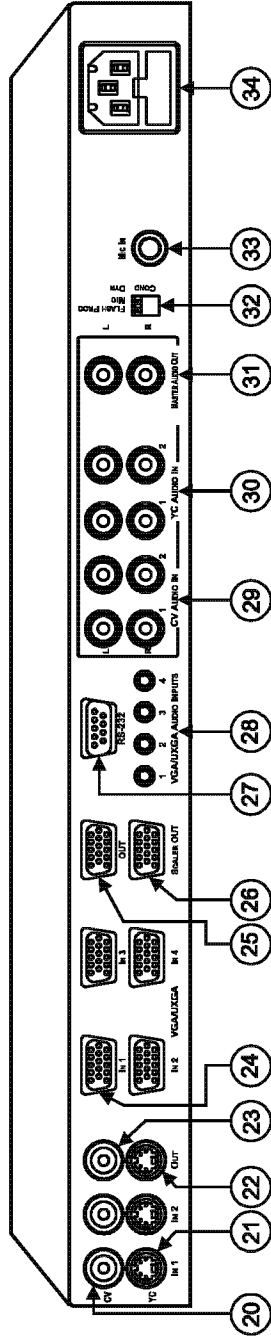
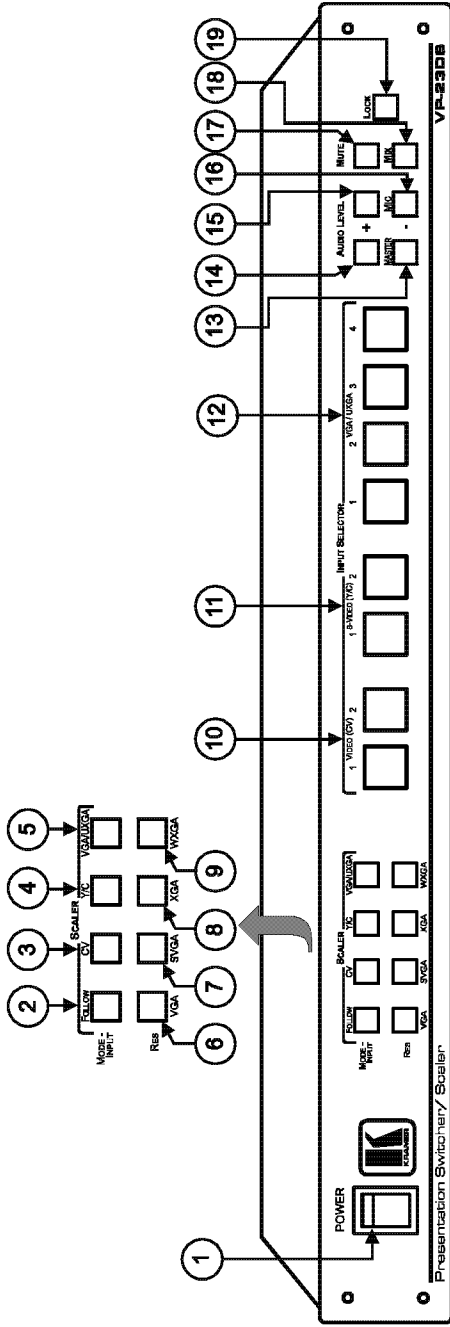

Figure 1: VP-23DS Presentation Switcher / Scaler

Table 1: Front Panel VP-23DS Presentation Switcher / Scaler Features

| # | Feature | | Function | |
|----|---|-------------------|--|--|
| 1 | POWER Switch | | Illuminated switch for turning the unit ON or OFF | |
| 2 | SCALER ¹ MODE - INPUT Buttons | FOLLOW | Press ² so that the scaler output will follow the last selected video input Release to select the scaler output independently (by pressing the CV, Y/C or VGA/UXGA scaler buttons) | |
| 3 | | CV | Press to route the selected CV input to the scaled ³ output ⁴ | |
| 4 | | Y/C | Press to route the selected Y/C input to the scaled ³ output ⁴ | |
| 5 | | VGA/UXGA | Press to route the selected VGA/UXGA input to the scaled output ⁴ Note that the VGA/UXGA is not scaled. It is routed directly to the scaled output | |
| 6 | | RES Buttons | VGA | Press to select the VGA (640x480) output resolution |
| 7 | | | SVGA | Press to select the SVGA (800x600) output resolution |
| 8 | | | XGA | Press to select the XGA (1024x768) output resolution |
| 9 | | | WXGA | Press to select the WXGA (1366x768) output resolution |
| 10 | | INPUT SELECTOR | VIDEO (CV) Buttons | Select the composite video and audio input (from 1 to 2) |
| 11 | s-VIDEO (Y/C) Buttons | | Select the s-Video and audio input (from 1 to 2) | |
| 12 | VGA/UXGA Button | | Select the VGA/UXGA video and audio input (from 1 to 4) | |
| 13 | AUDIO LEVEL | MASTER | - Button | Decrease the master audio signal level |
| 14 | | | + Button | Increase the master audio signal level |
| 15 | | MIC | + Button | Increase the microphone audio signal level |
| 16 | | | - Button | Decrease the microphone audio signal level |
| 17 | MUTE Button | | Press to disable/enable the Master Audio output ⁵ | |
| 18 | MIX Button | | Press to toggle. When on, will mix the microphone signal with the Master Audio output ⁶ . When OFF, the microphone signal is not available at the master audio output | |
| 19 | LOCK Button | | Press and hold ⁷ to lock/unlock the front panel buttons | |

1 See section 7.2

2 Button illuminates

3 Scaled according to the resolution selected using the RES button

4 In the FOLLOW mode, the button illuminates if this is the last input routed to the master output. In the breakaway mode, press to select the input to route to the scaler output

5 Except for the microphone signal in the MIX mode

6 When the MUTE button and the MIX button are on, only the microphone signal is transferred to the output

7 For about 2 seconds

Your VP-23DS Presentation Switcher / Scaler

Table 2: Rear Panel VP-23DS Presentation Switcher / Scaler Features

| # | Feature | | Function |
|----|--|----------------|--|
| 20 | CV IN RCA Connectors | | Connect to the composite video sources (from IN 1 to IN 2) |
| 21 | YC IN 4p Connectors | | Connect to the s-Video sources (from IN 1 to IN 2) |
| 22 | YC OUT 4p Connector | | Connect to the s-Video acceptor |
| 23 | CV OUT RCA Connector | | Connect to the composite video acceptor |
| 24 | VGA/UXGA IN HD15 Connectors | | Connect to the VGA/UXGA video sources (from IN 1 to 4) |
| 25 | VGA/UXGA OUT HD15 Connector | | Connect to the VGA/UXGA video acceptor |
| 26 | SCALER OUT HD15 Connector | | Connect to the VGA-UXGA acceptor ¹ |
| 27 | RS-232 Connector | | DB 9F connector connects to PC or Remote Controller |
| 28 | VGA/UXGA AUDIO INPUTS 3.5mm Mini Jack Connectors | | Connect to the VGA/UXGA unbalanced stereo audio sources (from 1 to 4) |
| 29 | CV AUDIO IN RCA Connectors (L and R) | | Connect to the CV unbalanced stereo audio sources (from 1 to 2) |
| 30 | YC AUDIO IN RCA Connectors (L and R) | | Connect to the s-Video unbalanced stereo audio sources (from 1 to 2) |
| 31 | MASTER AUDIO OUT RCA Connectors | | Connect to the stereo audio acceptor ² |
| 32 | Dipswitches | FLASH PROGRAM | Select between NORMAL for normal operation (the factory default), and FLASH PROGRAM to upgrade to the latest Kramer firmware (see section 8) |
| | | COND / DYN MIC | Select between a condenser and a dynamic microphone |
| 33 | MIC IN 6.3mm Phone Jack Connector | | Connects to the microphone |
| 34 | Power Connector with Fuse | | AC connector enabling power supply to the unit |

1 Displays the scaled output

2 The input selector button last pressed transmits the audio input signal of the selected channel to the master audio output

5 Installing the VP-23DS on a Rack

This section describes what to do before installing on a rack and how to rack mount.

Before Installing on a Rack

| | |
|--|------------------------------|
| Before installing on a rack, be sure that the environment is within the recommended range: | |
| Operating temperature range | +5 to +45 Deg. Centigrade |
| Operating humidity range | 5 to 65% RHL, non-condensing |
| Storage temperature range | -20 to +70 Deg. Centigrade |
| Storage humidity range | 5 to 95% RHL, non-condensing |



CAUTION!!

When installing on a 19" rack, avoid hazards by taking care that:

- 1 It is located within the recommended environmental conditions, as the operating ambient temperature of a closed or multi unit rack assembly may exceed the room ambient temperature.
- 2 Once rack mounted, enough air will still flow around the machine.
- 3 The machine is placed straight in the correct horizontal position.
- 4 You do not overload the circuit(s). When connecting the machine to the supply circuit, overloading the circuits might have a detrimental effect on overcurrent protection and supply wiring. Refer to the appropriate nameplate ratings for information. For example, for fuse replacement, see the value printed on the product label.
- 5 The machine is earthed (grounded) in a reliable way and is connected only to an electricity socket with grounding. Pay particular attention to situations where electricity is supplied indirectly (when the power cord is not plugged directly into the socket in the wall), for example, when using an extension cable or a power strip, and that you use only the power cord that is supplied with the machine.

How to Rack Mount

To rack-mount a machine:

- 1 Attach both ear brackets to the machine. To do so, remove the screws from each side of the machine (3 on each side), and replace those screws through the ear brackets.

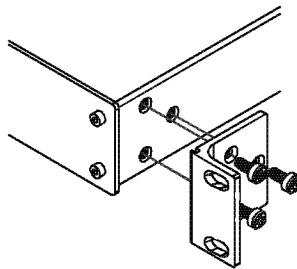

- 2 Place the ears of the machine against the rack rails, and insert the proper screws (not provided) through each of the four holes in the rack ears.

Note that:

- In some models, the front panel may feature built-in rack ears
- Detachable rack ears can be removed for desktop use
- Always mount the machine in the rack before you attach any cables or connect the machine to the power
- If you are using a Kramer rack adapter kit (for a machine that is not 19"), see the Rack Adapters user manual for installation instructions (you can download it at: <http://www.kramerelectronics.com>)

6 Connecting the VP-23DS Presentation Switcher / Scaler

In Figure 2, the audio input connections are not shown, except for the microphone and the MASTER AUDIO OUT. In this example, all the outputs are connected to the same projector. Use the projector controller to switch between the **VP-23DS** video outputs¹.

To connect² the **VP-23DS**, as illustrated in the example in Figure 2, do the following³:

1. Connect the following video sources:
 - One⁴ composite video source (for example, composite video player 1) to the CV IN 1 RCA connector
 - One⁴ composite video source (for example, a composite video player 2) to the CV IN 2 RCA connector
 - One s-Video source (for example, s-Video player 1) to the YC IN 1 4p connector
 - One s-Video source (for example, s-Video player 2) to the YC IN 2 4p connector
 - One⁴ VGA/UXGA source (for example, a computer graphics source) to the VGA/UXGA IN 1 HD15F connector
2. Connect the acceptors to a projector⁵ as follows:
 - The composite video CV OUT RCA connector to the composite video input of the projector
 - The s-Video YC OUT 4p connector to the s-Video input of the projector
 - The VGA/UXGA OUT HD15F connector to the VGA/UXGA input of the projector
3. Connect the SCALER OUT HD15F connector to an acceptor (for example, a VGA display).
4. Connect the appropriate unbalanced stereo audio sources (not shown in Figure 2).
5. Connect the MASTER AUDIO OUT RCA connectors to an amplifier with speakers.

1 Or the projector inputs

2 You do not need to connect all the inputs

3 Switch OFF the power on each device before connecting it to your VP-23DS. After connecting your VP-23DS, switch on its power and then switch on the power on each device. Switching on the VP-23DS, recalls the previous setup from the non-volatile memory

4 Although in this example not all the sources are connected, you can connect all of the inputs, that is, eight in total

5 In this example a projector is used, but you can also connect separate outputs such as displays, video recorders and so on

6. If required, connect a dynamic or a condenser microphone¹ to the MIC IN 6.3mm phone jack connector.
7. As an option, you can connect a PC and/or controller to the RS-232 port (see section 6.1).
8. Connect the power cord (not shown in Figure 2).

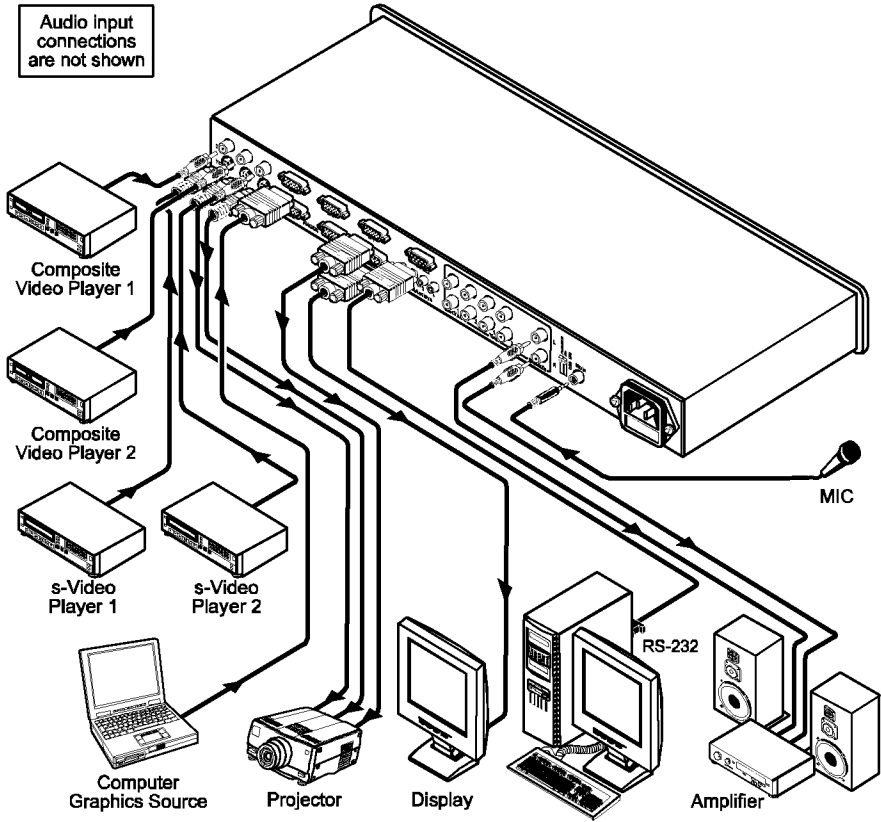

Figure 2: Connecting the VP-23DS Presentation Switcher / Scaler

¹ Use the DYN / COND MIC switch (on the rear panel) to select a dynamic microphone or a condenser

6.1 Connecting a PC

You can connect a PC (or other controller) to the **VP-23DS** via the RS-232 port.

To connect using the Null-modem adapter provided with the machine (recommended method):

- Connect the RS-232 DB9 rear panel port on the **VP-23DS** to the Null-modem adapter and connect the Null-modem adapter with a 9-wire flat cable to the RS-232 DB9 port on your PC

To connect without using a Null-modem adapter:

- Connect the RS-232 DB9 port on your PC to the RS-232 DB9 rear panel port on the **VP-23DS**, as Figure 3 illustrates

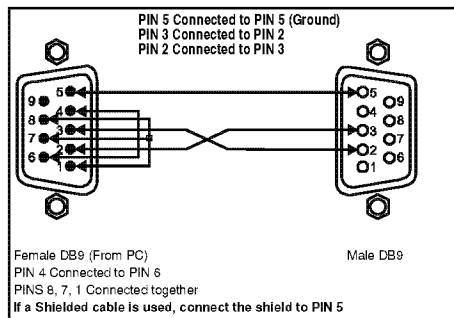

Figure 3: Connecting a PC without using a Null-modem Adapter

7 Operating the VP-23DS Presentation Switcher / Scaler

You can operate your **VP-23DS** via:

- The front panel buttons
- RS-232 serial commands transmitted by a touch screen system, PC, or other serial controller

The front panel buttons include the:

- Switcher section buttons: the INPUT SELECTOR buttons, the MASTER and MIC AUDIO LEVEL BUTTONS, and the MUTE, LOCK and MIX buttons
- Scaler section buttons: the FOLLOW, CV, Y/C and VGA/UXGA MODE-INPUT buttons, as well as the VGA, SVGA, XGA and WXGA resolution buttons

7.1 Operating your Switcher

You can select the video signals within each switcher group by pressing the relevant INPUT SELECTOR¹ buttons. You can switch one² of the:

- Two composite video (CV) inputs to the composite video output
- Two s-Video (Y/C) inputs to the s-Video output
- Four VGA/UXGA inputs to the VGA/UXGA output

The selected button in each group is illuminated in red³.

The **VP-23DS** operates in the audio-follow-video⁴ (AFV) mode so that the audio signal follows the selected video input signal.

The audio signal is routed to the MASTER AUDIO OUT output, therefore the last INPUT SELECTOR button selected (from any of the switcher groups) will route the audio signal of that input to the audio output.

The last selected button is illuminated in purple to indicate the source of the outputted audio signal

1 You can overlook a switcher group and choose not to select a button from it

2 You cannot select more than one button in a group

3 Pressing an illuminated button for more than 2 seconds will disconnect the output and the button will no longer illuminate

4 In which all operations relate to both the video and the audio channels

When setting the master audio gain to its minimum, the MUTE button illuminates.

When MIX is OFF, then the microphone signal is not available at the master audio output.

When MIX is ON and MUTE is OFF, the microphone signal is mixed with the master audio output.

When both the MUTE and MIX buttons are ON, only the microphone signal is transferred to the master output.

The MUTE and MIX buttons can be turned ON or OFF via RS-232 control and their respective buttons on the front panel illuminate.

7.2 Operating the Scaler Section

The SCALER section can operate in the FOLLOW or the breakaway mode:

- In the FOLLOW mode, the FOLLOW button illuminates, and the Scaler output follows the last selected video input
For example, if the last selected input is VIDEO (CV) 2, its INPUT SELECTOR button is illuminated (in purple) and in the SCALER section, the CV button illuminates (as well as the FOLLOW button) indicating that CV INPUT 2 is scaled and routed to the SCALER output
- In the Scaler breakaway mode, the FOLLOW button is not illuminated and the input to the SCALER output is selected by pressing appropriate SCALER button
For example, if the last selected master output is s-VIDEO (Y/C) 2, select the Scaler output by pressing one of the three SCALER buttons: CV, Y/C or VGA/UXGA

You can select the desired Scaler output resolution by pressing one of the four resolution buttons: VGA, SVGA, XGA or WXGA.

8 Flash Memory Upgrade

The **VP-23DS** firmware is located in FLASH memory, which lets you upgrade to the latest Kramer firmware version in minutes! The process involves:

- Downloading from the Internet (see section 8.1)
- Connecting the PC to the RS-232 port (see section 8.2)
- Upgrading Firmware (see section 8.3)

8.1 Downloading from the Internet

You can download the up-to-date file¹ from the Internet. To do so:

1. Go to our Web site at <http://www.kramerelectronics.com> and download the file: “*FLIP_VP23DS.zip*” from the Technical Support section.
2. Extract the file: “*FLIP_VP23DS.zip*” to a folder (for example, C:\Program Files\Kramer Flash).
3. Create a shortcut on your desktop to the file: “*FLIP.EXE*”.

8.2 Connecting the PC to the RS-232 Port

Before installing the latest Kramer firmware version on a **VP-23DS** unit, do the following:

1. Disconnect the power on the **VP-23DS**.
2. Connect the RS-232 DB9 rear panel port on the **VP-23DS** unit to the Null-modem adapter and connect the Null-modem adapter with a 9-wire flat cable to the RS-232 DB9 COM port on your PC (see section 6.1).
3. On the rear panel, set the FLASH PROG DIP to Flash Program (by setting the FLASH PROG DIP downwards, see Figure 4).
4. Connect the power on the VP-23DS unit and switch it ON.

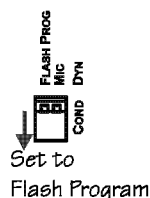

Figure 4: Setting the DIP to Flash Program

8.3 Upgrading Firmware

Follow these steps to upgrade the firmware:

1. Double click the desktop icon: “*Shortcut to FLIP.EXE*”.
- The Splash screen appears as follows:

¹ The files indicated in this section are given as an example only. These file names are liable to change from time to time

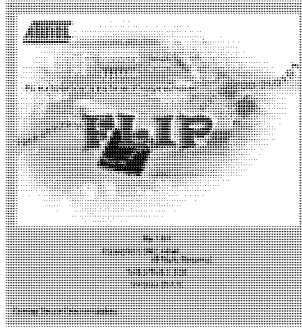

Figure 5: Splash Screen

2. After a few seconds, the Splash screen is replaced by the “Atmel – Flip” window:

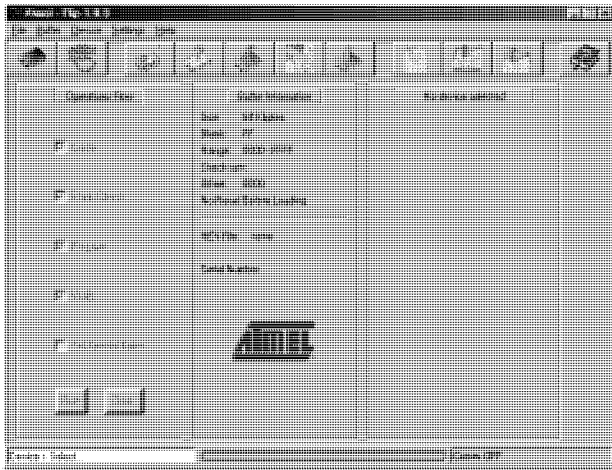

Figure 6: Atmel – Flip Window

3. Press the keyboard shortcut key *F2* (or select the “Select” command from the *Device* menu, or press the integrated circuit icon in the upper right corner of the window).

The “Device Selection” window appears:

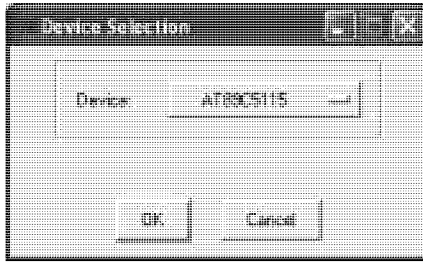

Figure 7: Device Selection Window

4. Click the button next to the name of the device and select from the list: AT89C51RD2:

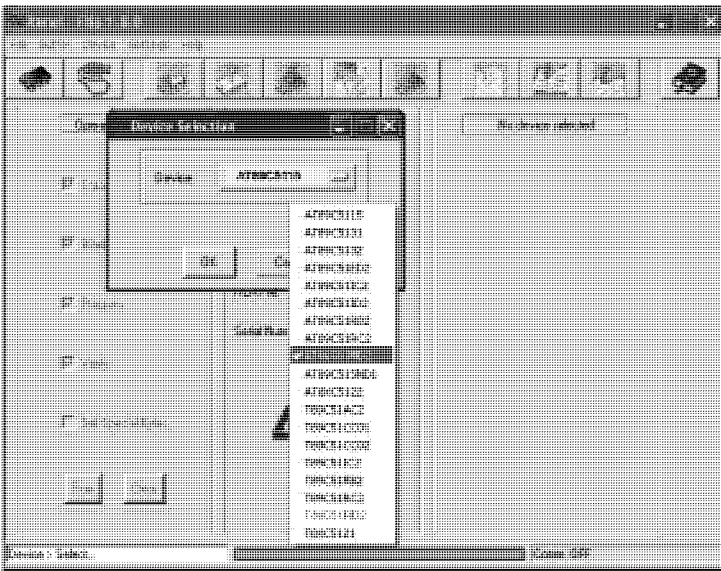

Figure 8: Selecting the Device from the Selection Window

5. Click OK and select “Load Hex” from the File menu.

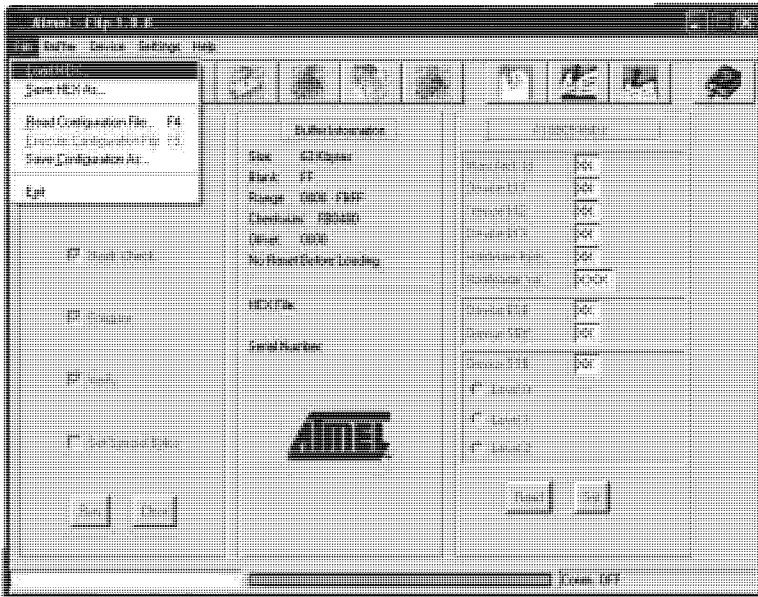

Figure 9: Loading the Hex

6. The Open File window opens. Select the correct HEX file that contains the updated version of the firmware for **VP-23DS** (for example, **23DSM_Vip2.hex**) and click Open.
7. Press the keyboard shortcut key **F3** (or select the “*Communication / RS232*” command from the *Settings* menu, or press the keys: **Alt SCR**). The “*RS232*” window appears. Change the COM port according to the configuration of your computer and select the 9600 baud rate:



Figure 10: RS-232 Window

8. Click Connect.
In the “*Atmel – Flip*” window, in the *Operations Flow* column, the *Run* button is active, and the name of the chip appears as the name of the third column: **AT89C51RD2**.

Verify that in the *Buffer Information* column, the “*HEX File: VP23DS.hex*” appears.

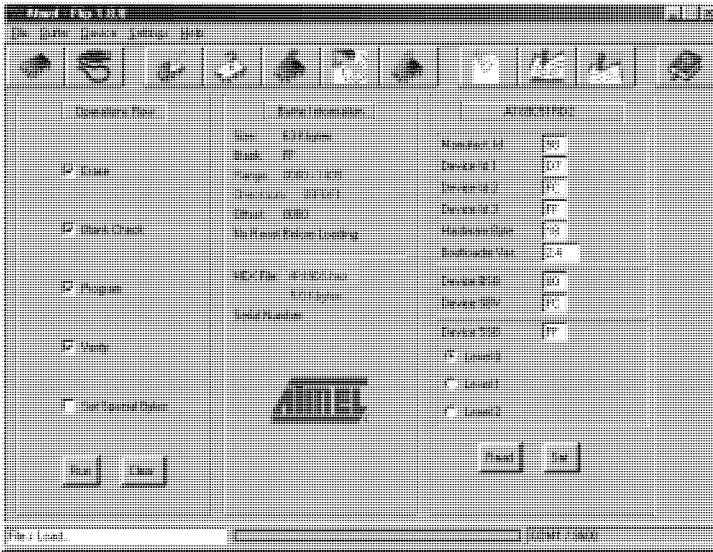

Figure 11: Atmel – Flip Window (Connected)

9. Click *Run*.

After each stage of the operation is completed, the check-box for that stage becomes colored green¹.

When the operation is completed, all 4 check-boxes will be colored green and the status bar message: *Memory Verify Pass* appears²:

¹ See also the blue progress indicator on the status bar

² If an error message: “Not Finished” shows, click Run again

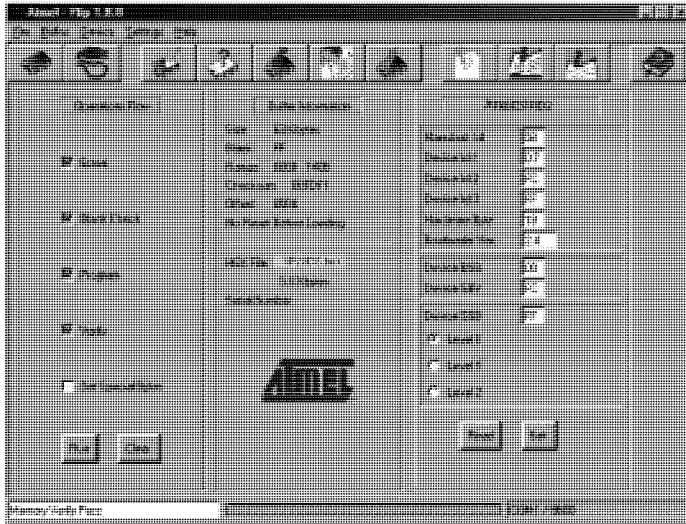

Figure 12: Atmel – Flip Window (Operation Completed)

10. Close the “Atmel – Flip” window.
11. Disconnect the power on the **VP-23DS**.
12. Disconnect the RS-232 rear panel port on the **VP-23DS** unit from the Null-modem adapter.
13. On the rear panel, set the FLASH PROG DIP to normal (by setting the FLASH PROG DIP set upwards, see Figure 13).
14. Connect the power to the **VP-23DS**.

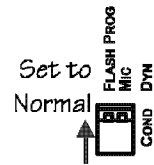

Figure 13: Setting the DIP to Normal

9 Technical Specifications

Table 3 includes the technical specifications:

Table 3: Technical Specifications¹ of the VP-23DS Presentation Switcher

| | | |
|----------------------------|--|---------------------------------|
| INPUTS: | 2 composite video (1Vpp/75Ω) on RCA connectors 2 s-Video 1 Vpp (Y), 0.3Vpp (C) / 75Ω on 4p connectors 4 VGA/UXGA on HD15F connectors 4 unbalanced stereo audio on 3.5mm jack connectors (for VGA/UXGA) +4dBm/10kΩ 4 unbalanced stereo audio channels +4dBm / 10kΩ on RCA connectors (2 for CV and 2 for YC) Mic: 3mV / 10kΩ condenser / dynamic on a 6.3mm Phone Jack connector | |
| OUTPUTS: | 1 composite video (1Vpp/75Ω) on an RCA connector 1 s-Video 1Vpp (Y), 0.3Vpp (C) / 75Ω on a 4p connector 1 VGA/UXGA on an HD15F connector 1 VGA/UXGA scaler out on an HD15F connector 1 unbalanced stereo master audio channel +4dBm / 50Ω on RCA connectors | |
| SCALED OUTPUT RESOLUTIONS: | VGA (640 x 480), SVGA (800 x 600), XGA (1024 x 768) and WXGA (1366 x 768) | |
| MAX. OUTPUT LEVEL: | VIDEO: 2.1Vpp; XGA: 0.77Vpp | AUDIO: 27Vpp |
| BANDWIDTH (-3dB): | VIDEO: VGA / UXGA: 400MHz; s-Video (Y): 310MHz; Composite/SDI video: 310MHz; HDTV compatible | AUDIO: 40kHz |
| DIFF. GAIN: | <0.07% all channels | |
| DIFF. PHASE: | <0.05 Deg. all channels | |
| S/N RATIO: | VIDEO: 75dB all channels | AUDIO: 75dB /1 Vpp all channels |
| CONTROLS: | 10 selector buttons, master audio level, mic audio level, mix, lock, mute, RS-232 | |
| POWER SOURCE: | 100-240V AC, 50/60Hz, (115V AC, U.S.A.) 7VA | |
| DIMENSIONS: | 19-inch (W), 7-inch (D) 1U (H) rack-mountable | |
| WEIGHT: | 2.6kg (8lbs.) approx | |
| ACCESSORIES: | Power cord, Null modem adapter, Windows®-based Kramer control software | |

¹ Specifications are subject to change without notice

10 Hex Tables

Table 4 lists the Hex values (which the protocol in section 11 describes in more detail) for the **VP-23DS Presentation Switcher**:

Table 4: VP-23DS Hex Table

| Inputs | | Composite Video OUT | s-Video OUT | VGA/UXGA OUT |
|-----------------|------|---------------------|-------------|--------------|
| Group | # | | | |
| Composite Video | In 1 | 01 81 81 81 | | |
| | In 2 | 01 82 81 81 | | |
| s-Video | In 1 | | 01 81 82 81 | |
| | In 2 | | 01 82 82 81 | |
| VGA / UXGA | In 1 | | | 01 81 83 81 |
| | In 2 | | | 01 82 83 81 |
| | In 3 | | | 01 83 83 81 |
| | In 4 | | | 01 84 83 81 |

Table 5: VP-23DS Master Audio Selector Hex Table

| Master Audio Selector | |
|-----------------------|-------------|
| Composite Video Group | 02 81 81 81 |
| s-Video Group | 02 82 81 81 |
| VGA / UXGA Group | 02 83 81 81 |
| Microphone | 02 85 81 81 |

10.1 Audio Gain Control Hex Tables

Table 6 and Table 7 describe the audio gain controls¹:

Table 6: Set the Relative Audio Output²

| Set Relative Audio Gain of Master Audio Out Gain | |
|--|------|
| 16 81 80 81 | Mute |
| ⋮ | |
| 16 81 D3 81 | -6dB |
| ⋮ | |
| 16 81 DF 81 | 0dB |
| ⋮ | |
| 16 81 EB 81 | 6dB |
| ⋮ | |
| 16 81 FF 81 | 16dB |

Table 7: Increase or Decrease the Audio Output Gain by One Step

| | Master Out | Microphone |
|-----------------|-------------|-------------|
| Increase | 18 81 80 81 | 18 82 80 81 |
| Decrease | 18 81 81 81 | 18 82 81 81 |

¹ When controlling the VP-23DS via RS-232, refer to note 9 for command 42 in the communication protocol (see section 11)

² For the microphone gain control, the second byte equals 82

11 VP-23DS Communication Protocol

The **VS-23DS** is compatible with Kramer's Protocol 2000 (version 0.48) (below). This RS-232/RS-485 communication protocol uses four bytes of information as defined below. For RS-232, a null-modem connection between the machine and controller is used. The default data rate is 9600 baud, with no parity, 8 data bits and 1 stop bit.

Table 8: Protocol Definitions

| MSB | | | | | | | | LSB |
|----------|----------------|-------------|----|----|----|----|----|-----|
| | DESTINATION | INSTRUCTION | | | | | | |
| 0 | D | N5 | N4 | N3 | N2 | N1 | N0 | |
| 7 | 6 | 5 | 4 | 3 | 2 | 1 | 0 | |
| 1st byte | | | | | | | | |
| | INPUT | | | | | | | |
| 1 | I6 | I5 | I4 | I3 | I2 | I1 | I0 | |
| 7 | 6 | 5 | 4 | 3 | 2 | 1 | 0 | |
| 2nd byte | | | | | | | | |
| | OUTPUT | | | | | | | |
| 1 | O6 | O5 | O4 | O3 | O2 | O1 | O0 | |
| 7 | 6 | 5 | 4 | 3 | 2 | 1 | 0 | |
| 3rd byte | | | | | | | | |
| | MACHINE NUMBER | | | | | | | |
| 1 | OVR | X | M4 | M3 | M2 | M1 | M0 | |
| 7 | 6 | 5 | 4 | 3 | 2 | 1 | 0 | |
| 4th byte | | | | | | | | |

1st BYTE: Bit 7 – Defined as 0.

D – “DESTINATION”: 0 - for sending information to the switchers (from the PC);

1 - for sending to the PC (from the switcher).

N5...N0 – “INSTRUCTION”

The function that is to be performed by the switcher(s) is defined by the INSTRUCTION (6 bits). Similarly, if a function is performed via the machine's keyboard, then these bits are set with the INSTRUCTION NO., which was performed. The instruction codes are defined according to the table below (INSTRUCTION NO. is the value to be set for N5...N0).

2nd BYTE: Bit 7 – Defined as 1.

I6...I0 – “INPUT”.

When switching (ie. instruction codes 1 and 2), the INPUT (7 bits) is set as the input number which is to be switched. Similarly, if switching is done via the machine's front-panel, then these bits are set with the INPUT NUMBER which was switched. For other operations, these bits are defined according to the table.

3rd BYTE: Bit 7 – Defined as 1.

O6...O0 – “OUTPUT”.

When switching (ie. instruction codes 1 and 2), the OUTPUT (7 bits) is set as the output number which is to be switched. Similarly, if switching is done via the machine's front-panel, then these bits are set with the OUTPUT NUMBER which was switched. For other operations, these bits are defined according to the table.

4th BYTE: Bit 7 – Defined as 1.

Bit 5 – Don't care.

OVR – Machine number override.

M4...M0 – MACHINE NUMBER.

Used to address machines in a system via their machine numbers. When several machines are controlled from a single serial port, they are usually configured together with each machine having an individual machine number. If the OVR bit is set, then all machine numbers will accept (implement) the command, and the addressed machine will reply.

For a single machine controlled via the serial port, always set M4...M0 = 1, and make sure that the machine itself is configured as MACHINE NUMBER = 1.

Table 9: Instruction Codes

| INSTRUCTION | | DEFINITION FOR SPECIFIC INSTRUCTION | | NOTE | | |
|-------------|--|---|---|-----------------|---------------------------|-------------|
| # | DESCRIPTION | INPUT | OUTPUT | | | |
| 0 | RESET MACHINE | 0 | 0 | 1 | | |
| 1 | SWITCH GROUPS | 1-2 | 1-2 (1 – for CV group, 2 – for SV group) | 2 | | |
| | | 1-4 | 3 – for VGA group | | | |
| | | 1 – from CV group 2 – from SV group 3 – from VGA group | 4 – for Scaler | | | |
| | | Set equal to video (and audio) input to be switched for the relative group | Set equal to group to which output is to be switched | | | |
| 2 | SWITCH AUDIO OUTPUTS TO MASTER AUDIO OUT | 1-4* Set equal to audio output to be switched to Master Audio out | 1 | 2 | | |
| 5 | REQUEST GROUP STATUS | 0 | 1-4 Set equal to the group of which status is required | 3 | | |
| 6 | REQUEST STATUS OF MASTER AUDIO OUTPUT | 0 | 1 | 3 | | |
| 8 | BREAKAWAY SETTING | 1 | 0 – Scaler FOLLOW mode 1 – Scaler Normal mode | 10 | | |
| 9 | VIDEO/AUDIO TYPE SETTING | 2 – for scaler resolution | 1 – VGA (640x480) 2 – SVGA (800x600) 3 – XGA (1024x768) 4 - WXGA | 11 | | |
| 11 | REQUEST BREAKAWAY SETTING | 0 | 1 – Request Scaler "FOLLOW" setting | 3,12 | | |
| 12 | REQUEST VIDEO/AUDIO TYPE SETTING | 0 | 2 – for scaler resolution | 3,12 | | |
| 16 | ERROR | Don't care | 0 – Invalid instruction 1 – Out of range 6 – Receive buffer overflow | 4 | | |
| 18 | RESET MACHINE | 0 | 0 | 1 | | |
| 22 | SET AUDIO PARAMETER | Parameter | Value | Parameter | Value: | 2, 7, 8, 9, |
| | | Audio gain: | 1 – Audio Master 2 –Microphone | Audio gain: | 0-127 | |
| | | Mix microphone: | 0 | Mix microphone: | 0 – mix OFF 1 – Mix ON | |
| 24 | INCREASE/DECREASE AUDIO PARAMETER | 1 – audio master 2 – microphone | 0 - increase output 1 - decrease output | 8 | | |
| 25 | REQUEST AUDIO PARAMETER | Equal to input / output number whose parameter is requested 1 – audio master 2 – microphone | 0 | 9 | | |
| 30 | LOCK FRONT PANEL | 0 – Panel unlocked 1 – Panel locked | 0 | 2 | | |
| 31 | REQUEST WHETHER PANEL IS LOCKED | 0 | 0 | 3 | | |
| 42 | AUDIO PARAMETER SETTINGS FOR INSTRUCTIONS 22, 25 | 0 | 0 - Gain 4 - Mix mode | 9 | | |
| 55 | REPLY ON | 0 | 0 - Off 1 - On | | | |
| 57 | SET AUTO SAVE | 1 – Autosave 2 – No save | | 5 | | |
| 61 | IDENTIFY MACHINE | 1 or 2 – Machine name 3 or 4 – Program version | 0 – request first 4 digits 1 – request first suffix 10 – request first prefix | 6 | | |
| 62 | DEFINE MACHINE | 8 – Number of inputs 4 – Number of outputs | 1 – For video 2 – For audio | 3 | | |

NOTE 1

When the master switcher is reset, (e.g. when it is turned on), the reset code is sent to the PC. If this code is sent to the switchers, it will reset according to the present power-down settings.

NOTE 2

These are bi-directional definitions. That is, if the switcher receives the code, it will perform the instruction; and if the instruction is performed (due to a keystroke operation on the front panel), then these codes are sent. For example, if:

0000 0001 Instruction "Switch Groups"

1000 0010 Input #2

1000 0001 in composite video group

1000 0001 Machine #1 (master)

Was sent from the PC, then the switcher (machine #1) will switch input 2 in composite video group to its output. If the user switched input 4 in the VGA group via the front panel keypad, then the switcher will send:

0100 0001

1000 0100

1000 0100

1000 0001 to the PC.

When the PC sends instruction #1 or #2 to the switcher, then, if the instruction is valid, the switcher replies by sending the same four bytes to the PC that were sent (except for the first byte, where the DESTINATION bit is set high).

NOTE 3

The reply to a "REQUEST" instruction is as follows: the same instruction and input codes as were sent are returned, and the OUTPUT is assigned to the value of the requested parameter. The reply to the instruction #5 (what is the status of the VGA group?):

0000 0101

1000 0000

1000 0011

1000 0001

Would be:

0100 0101

1000 0000

1000 0100

1000 0001

NOTE 4

An error code is returned to the PC if an invalid code was sent to the switcher (for example, when trying to switch an input or a group which is greater than the highest one defined). This code is also returned to the PC if an RS-232 instruction is sent while the machine is being programmed via the front panel. Reception of this code by the switcher will not be valid.

NOTE 5

Under normal conditions, the machine's present status is saved each time a change is made. The power-down save (the auto save) may be disabled using this code. Note that each time that the machine is turned ON, the auto save function is automatically set.

NOTE 6

This is a request to identify the switchers in a system. If the INPUT is set as 1 or 2, the machine will send its name. The reply is the decimal value of the INPUT and the OUTPUT. For example, the reply to the request to send the machine's name (for machine #001) will be:

0111 1101

1000 0000 (i.e. 128+0)

1001 0111 (i.e. 128+23)

1000 0001

If the request for identification is sent with the INPUT set as 3 or 4, the appropriate machine will send its software version number. Again, the reply would be the decimal value of the INPUT and OUTPUT - the INPUT representing the number in front of the decimal point, and the OUTPUT representing the number following the decimal point. For example, for version 3.5 the reply will be:

0111 1101

1000 0011 (i.e. 128+3)

1000 0101 (i.e. 128+5)

1000 0001

NOTE 7

GAIN VALUE – Number from 0 to 127

NOTE 8

Answer = Current Audio Gain (0–127)

If the Audio Gain = 0, the MUTE button is illuminated

NOTE 9

When changing parameters (mix or gain), further information needed in instructions 22 and 25 is sent using instruction 42 – which is sent prior to the instruction. For example, to request the audio gain value of the master audio output

| | | | |
|-------------------------|----|----|-----|
| 2A | 80 | 80 | 81 |
| and then send HEX codes | | | |
| 19 | 81 | 80 | 81. |

To set MIX mode, send hex codes

| | | | |
|-------------------------|----|----|----|
| 2A | 81 | 84 | 81 |
| and then send HEX codes | | | |
| 16 | 80 | 81 | 81 |

NOTE 10

The FOLLOW mode is for the switcher and scaler system. When changing the status of a switcher group, the scaler input automatically connects to that group's output. For example, if the latest change in the switcher was in the SV group, then the scaler's input automatically connects to the SV group output

NOTE 11

This instruction selects the input signal resolutions of the scaler

NOTE 12

If INPUT is set to 127 for these instructions, then, if the function is defined on this machine, it replies with OUTPUT=1. If the function is not defined, then the machine replies with OUTPUT=0, or with an error (invalid instruction code).

If the INPUT is set to 126 for these instructions, then, if possible, the machine will return the current setting of this function, even for the case that the function is not defined. For example, request breakaway setting would be HEX code:

| | | | |
|---------------------|----|----|-----------------------------|
| 0B | 80 | 80 | 81 |
| would be HEX codes: | | | |
| 4B | 80 | 80 | 81 (for Scaler FOLLOW mode) |
| or: | | | |
| 4B | 80 | 81 | 81 (for Scaler normal mode) |

For example, request Scaler resolution would be HEX codes:

| | | | |
|---------------------|----|----|--------------------------|
| 0C | 80 | 80 | 81 |
| would be HEX codes: | | | |
| 0C | 80 | 81 | 81 (for VGA resolution) |
| 0C | 80 | 82 | 81 (for SVGA resolution) |
| 0C | 80 | 83 | 81 (for XGA resolution) |
| and | | | |
| 0C | 80 | 84 | 81 (for WXGA resolution) |

LIMITED WARRANTY

Kramer Electronics (hereafter *Kramer*) warrants this product free from defects in material and workmanship under the following terms.

HOW LONG IS THE WARRANTY

Labor and parts are warranted for seven years from the date of the first customer purchase.

WHO IS PROTECTED?

Only the first purchase customer may enforce this warranty.

WHAT IS COVERED AND WHAT IS NOT COVERED

Except as below, this warranty covers all defects in material or workmanship in this product. The following are not covered by the warranty:

1. Any product which is not distributed by Kramer, or which is not purchased from an authorized Kramer dealer. If you are uncertain as to whether a dealer is authorized, please contact Kramer at one of the agents listed in the Web site www.kramerelectronics.com.
2. Any product, on which the serial number has been defaced, modified or removed.
3. Damage, deterioration or malfunction resulting from:
 - i) Accident, misuse, abuse, neglect, fire, water, lightning or other acts of nature
 - ii) Product modification, or failure to follow instructions supplied with the product
 - iii) Repair or attempted repair by anyone not authorized by Kramer
 - iv) Any shipment of the product (claims must be presented to the carrier)
 - v) Removal or installation of the product
 - vi) Any other cause, which does not relate to a product defect
 - vii) Cartons, equipment enclosures, cables or accessories used in conjunction with the product

WHAT WE WILL PAY FOR AND WHAT WE WILL NOT PAY FOR

We will pay labor and material expenses for covered items. We will not pay for the following:

1. Removal or installations charges.
2. Costs of initial technical adjustments (set-up), including adjustment of user controls or programming. These costs are the responsibility of the Kramer dealer from whom the product was purchased.
3. Shipping charges.

HOW YOU CAN GET WARRANTY SERVICE

1. To obtain service on you product, you must take or ship it prepaid to any authorized Kramer service center.
2. Whenever warranty service is required, the original dated invoice (or a copy) must be presented as proof of warranty coverage, and should be included in any shipment of the product. Please also include in any mailing a contact name, company, address, and a description of the problem(s).
3. For the name of the nearest Kramer authorized service center, consult your authorized dealer.

LIMITATION OF IMPLIED WARRANTIES

All implied warranties, including warranties of merchantability and fitness for a particular purpose, are limited in duration to the length of this warranty.

EXCLUSION OF DAMAGES

The liability of Kramer for any effective products is limited to the repair or replacement of the product at our option. Kramer shall not be liable for:

1. Damage to other property caused by defects in this product, damages based upon inconvenience, loss of use of the product, loss of time, commercial loss; or:
2. Any other damages, whether incidental, consequential or otherwise. Some countries may not allow limitations on how long an implied warranty lasts and/or do not allow the exclusion or limitation of incidental or consequential damages, so the above limitations and exclusions may not apply to you.

This warranty gives you specific legal rights, and you may also have other rights, which vary from place to place.

NOTE: All products returned to Kramer for service must have prior approval. This may be obtained from your dealer.

This equipment has been tested to determine compliance with the requirements of:

- EN-50081: "Electromagnetic compatibility (EMC); generic emission standard.
Part 1: Residential, commercial and light industry"
- EN-50082: "Electromagnetic compatibility (EMC) generic immunity standard.
Part 1: Residential, commercial and light industry environment".
- CFR-47: FCC Rules and Regulations:
Part 15: "Radio frequency devices
Subpart B Unintentional radiators"

CAUTION!

- Servicing the machines can only be done by an authorized Kramer technician. Any user who makes changes or modifications to the unit without the expressed approval of the manufacturer will void user authority to operate the equipment.
- Use the supplied DC power supply to feed power to the machine.
- Please use recommended interconnection cables to connect the machine to other components.





For the latest information on our products and a list of Kramer distributors, visit our Web site: www.kramerelectronics.com, where updates to this user manual may be found. We welcome your questions, comments and feedback.

| | |
|----------------|---|
| | Safety Warning: |
| Caution | Disconnect the unit from the power supply before opening/servicing. |

