

**Kramer Electronics, Ltd.**



# **USER MANUAL**

**Model:**

**VP-81KSi**

*8x1 UXGA/Audio STEP-IN Switcher*

**Contents**

<b>1</b>	<b>Introduction</b>	<b>1</b>
<b>2</b>	<b>Getting Started</b>	<b>1</b>
2.1	Quick Start	1
<b>3</b>	<b>Overview</b>	<b>3</b>
3.1	Defining EDID	4
<b>4</b>	<b>Defining the VP-81KSi 8x1 UXGA/Audio STEP-IN Switcher</b>	<b>5</b>
4.1	Using the IR Transmitter for the VP-81KSi	7
<b>5</b>	<b>Installing in a Rack</b>	<b>8</b>
<b>6</b>	<b>Connecting the VP-81KSi 8x1 UXGA/Audio STEP-IN Switcher</b>	<b>9</b>
6.1	Connecting the Balanced/Unbalanced Stereo Audio Output	10
6.2	Connecting Remote Contact Closure Input Selection Switches	11
6.3	Connecting the SI-1VGA Remote Step-in Module	11
6.4	Connecting the AV ON CAT 5 Twisted Pair Output	12
6.5	Connecting to the VP-81KSi via the RS-232 Port	12
6.6	Connecting to the VP-81KSi via the RS-485 Port	13
6.6.1	Setting the RS-485 Machine Number and Bus Termination DIP-switches	13
6.6.2	Connecting and Controlling Multiple VP-81KSi Devices	14
6.7	Cascading Multiple VP-81KSi Devices	14
6.8	Connecting to the VP-81KSi via the Ethernet Port	15
6.8.1	Connecting Directly to the Ethernet Port	16
6.8.2	Connecting via a Network Hub, Switch, or Router	17
6.8.3	Configuring the Ethernet Port on the VP-81KSi	17
<b>7</b>	<b>Operating the VP-81KSi Locally via the Front Panel Buttons</b>	<b>19</b>
7.1	Using the Front Panel INPUT SELECTOR Buttons	19
7.2	Using the Audio-Follow-Video/Breakaway Modes	19
7.2.1	Operating in Breakaway Mode	20
7.2.2	Switching to Audio Follow Video Mode	20
7.3	Setting the Audio Output Gain	20
7.4	Operating Cascaded VP-81KSi Devices	20
<b>8</b>	<b>Operating the VP-81KSi Remotely</b>	<b>21</b>
<b>9</b>	<b>Operating the VP-81KSi Remotely using a Web Browser</b>	<b>21</b>
9.1	To Log On to the VP-81KSi Web Pages	22
9.2	The Switching Matrix Page	23
9.2.1	Switching an Input to an Output	24
9.2.2	Operating in the Confirm Mode	25
9.3	The Audio Gain Page	26
9.4	The Configurations Page	27
<b>10</b>	<b>Upgrading the Firmware</b>	<b>28</b>
<b>11</b>	<b>EDID</b>	<b>28</b>

<b>12</b>	<b>Technical Specifications</b>	<b>29</b>
<b>13</b>	<b>Communication Parameters</b>	<b>30</b>
<b>14</b>	<b>Default EDID</b>	<b>30</b>
<b>15</b>	<b>Table of ASCII Codes for Serial Communication (Protocol 3000)</b>	<b>31</b>
<b>16</b>	<b>Table of Hex Codes for Serial Communication (Protocol 2000)</b>	<b>32</b>
<b>17</b>	<b>Kramer Protocol</b>	<b>34</b>
17.1	Switching Protocols	34
17.1.1	Switching Protocols via the Front Panel Buttons	34
17.1.2	Switching Protocols via Protocol Commands	34
17.2	Kramer Protocol 3000	34
17.2.1	Protocol 3000 Syntax	35
17.2.2	Command Part Details	35
17.3	Kramer Protocol 2000	42

## Figures

Figure 1: VP-81KSi 8x1 UXGA/Audio STEP-IN Switcher Front Panel	5
Figure 2: VP-81KSi 8x1 UXGA/Audio STEP-IN Switcher Rear Panel	6
Figure 3: Connecting the VP-81KSi	9
Figure 4: Balanced Stereo Audio Connection	10
Figure 5: Unbalanced Stereo Audio Connection	10
Figure 6: Remote Input Selection Switch Wiring	11
Figure 7: Connecting the SI-1VGA	12
Figure 8: RS-485 DIP-switches	13
Figure 9: Cascading up to Eight VP-81KSi Devices	15
Figure 10: Local Area Connection Properties Window	16
Figure 11: Internet Protocol (TCP/IP) Properties Window	17
Figure 12: Connect Window	18
Figure 13: Device Properties Window	19
Figure 14: Java Test Page Success Message	21
Figure 15: The Loading Page	22
Figure 16: First Time Security Warning	23
Figure 17: VP-81KSi Switching Matrix Page	24
Figure 18: Switching an Input to an Output	25
Figure 19: Switching an Input to an Output	25
Figure 20: Exiting Offline Warning	26
Figure 21: Audio Gain Page	26
Figure 22: Configurations Page	27

## Tables

Table 1: VP-81KSi 8x1 UXGA/Audio STEP-IN Switcher Front Panel Features	5
Table 2: VP-81KSi 8x1 UXGA/Audio STEP-IN Switcher Rear Panel Features	6
Table 3: RS-485 DIP-switch Settings	13
Table 4: Machine Number DIP-switch Settings	14
Table 5: Button Illumination Descriptions	19
Table 6: Technical Specifications of the VP-81KSi	29
Table 7: Communication Parameters	30
Table 8: VP-81KSi Video and Audio Signal Codes	31
Table 9: VP-81KSi Audio Input Gain Codes	32
Table 10: VP-81KSi Audio and Audio Output Gain Codes	32
Table 11: VP-81KSi Hex Codes for Protocol 2000	32
Table 12: VP-81KSi Hex Codes that Increase/Decrease Audio Input Gain	32
Table 13: Hex Codes that Set the Audio Input Gain	33
Table 14: VP-8x8AK Hex Codes for Increasing/Decreasing the Output Gain	33
Table 15: Hex Codes for Setting the Audio Output Gain	33
Table 16: Instruction Codes for Protocol 3000	36
Table 17: Protocol Definitions	42
Table 18: Instruction Codes for Protocol 2000	43

## 1 Introduction

Welcome to Kramer Electronics! Since 1981, Kramer Electronics has been providing a world of unique, creative, and affordable solutions to the vast range of problems that confront the video, audio, presentation, and broadcasting professional on a daily basis. In recent years, we have redesigned and upgraded most of our line, making the best even better! Our 1,000-plus different models now appear in 11 groups<sup>1</sup> that are clearly defined by function.

Congratulations on purchasing your Kramer **VP-81KSi** 8x1 UXGA/Audio STEP-IN Switcher.

The **VP-81KSi** is ideal for:

- Display systems requiring simple input selection
- Remote monitoring of computer activity in schools and businesses
- Rental/staging applications
- Multimedia and presentation source selection

The package includes the following items:

- **VP-81KSi** 8x1 UXGA/Audio STEP-IN Switcher
- Infrared **RC-IR3** remote control transmitter (including the required battery and a separate user manual<sup>2</sup>)
- One **SI-1VGA** Remote Step-in Module and user manual<sup>2</sup>
- Power cord
- This user manual<sup>2</sup>

## 2 Getting Started

We recommend that you:

- Unpack the equipment carefully and save the original box and packaging materials for possible future shipment
- Review the contents of this user manual
- Use Kramer high performance high resolution cables<sup>3</sup>

### 2.1 Quick Start

This quick start chart summarizes the basic setup and operation steps.

---

<sup>1</sup> GROUP 1: Distribution Amplifiers; GROUP 2: Switchers and Matrix Switchers; GROUP 3: Control Systems; GROUP 4: Format/Standards Converters; GROUP 5: Range Extenders and Repeaters; GROUP 6: Specialty AV Products; GROUP 7: Scan Converters and Scalers; GROUP 8: Cables and Connectors; GROUP 9: Room Connectivity; GROUP 10: Accessories and Rack Adapters; GROUP 11: Sierra Products

<sup>2</sup> Download up-to-date Kramer user manuals from <http://www.kramerelectronics.com>

<sup>3</sup> The complete list of Kramer cables is available from <http://www.kramerelectronics.com>

**Step 1: Mount the machine - see Section 5**

Mount the machine in a rack or stick the 4 rubber feet to the underside



**Step 2: Connect the inputs and outputs - see Section 6**

- 1 Connect the inputs
- 2 Optional - Connect remote step-in panels
- 3 Connect the outputs
- 4 Optional - Connect remote input selection switches
- 5 Optional - Connect a controller

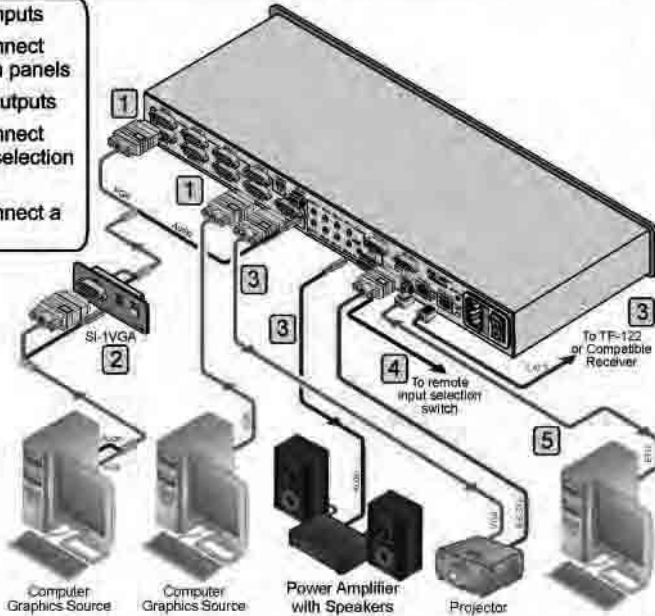

**Step 3: Switch the power on**

**Step 4: Operate the machine - see Sections 7, 8 and 9**

Select an input with one of the INPUT SELECTOR buttons

Lock the front panel via RS-232



AUDIO and VIDEO - Audio follows video when switching  
 VIDEO - Switching relates to the video signal  
 AUDIO - Switching relates to the audio signal



Increase or decrease the AUDIO GAIN (while the AUDIO button is lit)

Operate via the front panel buttons, IR remote controller, RS-232, RS-485 and Ethernet

### 3 Overview

The **VP-81KSi** routes any input to both outputs, using 15-pin HD female connectors for the computer graphics video signals, a 3.5mm mini jack for the unbalanced stereo audio Output 1 signal, and a detachable terminal block connector for the balanced stereo audio Output 2 signal.

In particular, the **VP-81KSi**:

- Has a very high video bandwidth ensuring transparent WUXGA performance
- Features audio-follow-video (AFV) in which all operations relate to both the video and the audio channels, or audio breakaway option, in which video and audio channels are switched independently
- Features volume control
- Includes the Kramer innovative integrated sync processing Kr-isp™ technology, which lets you achieve a sharp, stable image even when the sync level is too low, by restoring the sync signal waveform
- Can be cascaded with up to eight units to provide a single “virtual” switcher with up to 57 inputs
- Supports the **SI-1VGA Remote Step-in Panel** for remote inputs and remote step-in control

You can control the **VP-81KSi** using the front panel buttons, or remotely via:

- RS-485 or RS-232 serial commands transmitted by a touch screen system, PC or other serial controller
- Ethernet over a LAN using a Web browser
- The **SI-1VGA Remote Step-in Panel**
- The Kramer **RC-IR3** Infrared Remote Control Transmitter or infrared remote extension cable transmitter (optional)
- Remote, contact closure switches

To achieve the best performance:

- Connect only good quality connection cables, thus avoiding interference, deterioration in signal quality due to poor matching, and elevated noise levels (often associated with low quality cables)
- Avoid interference from neighboring electrical appliances that may adversely influence signal quality and position your **VP-81KSi** away from moisture, excessive sunlight and dust

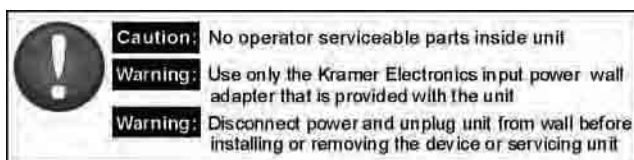

### 3.1 Defining EDID

The Extended Display Identification Data (EDID<sup>1</sup>) is a data-structure, provided by a display that describes its capabilities to a graphics card (that is connected to the display's source). The EDID enables the PC or laptop to "know" what kind of monitor is connected to the output. The EDID includes the manufacturer's name, product type, timing data supported by the display, display size, luminance data and (for digital displays only) pixel mapping data.

---

<sup>1</sup> Defined by a standard published by the Video Electronics Standards Association (VESA)



## 4 Defining the VP-81KSi 8x1 UXGA/Audio STEP-IN Switcher

Figure 1 and Table 1 define the front panel of the **VP-81KSi 8x1 UXGA/Audio STEP-IN Switcher**.

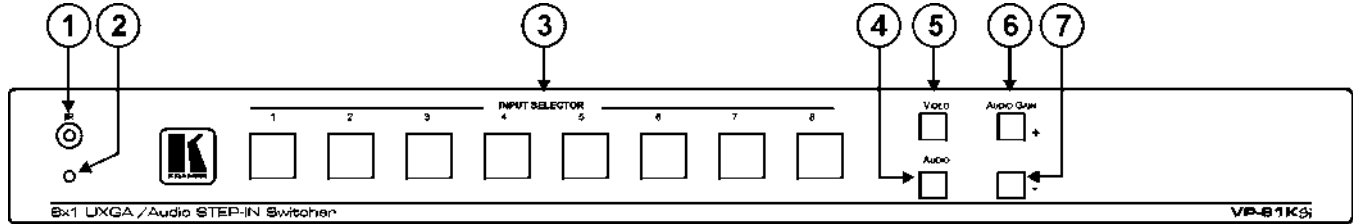

Figure 1: VP-81KSi 8x1 UXGA/Audio STEP-IN Switcher Front Panel

Table 1: VP-81KSi 8x1 UXGA/Audio STEP-IN Switcher Front Panel Features

#	Feature	Function
1	IR Sensor	Receiver for the IR Remote Control signal
2	IR LED	Lights yellow when the unit receives an IR signal
3	INPUT SELECTOR Buttons	Press to select the input (from 1 to 8) to switch to the outputs. The button lights red if it is selected and there is no input signal. The button lights green if it is not selected but there is an input signal at that input. The button lights violet if it is selected and there is an input signal connected
4	AUDIO Button	Press to execute audio related actions. The button lights when the audio mode is operational <sup>1</sup>
5	VIDEO Button	Press to execute video related actions. The button lights when the video mode is operational <sup>1</sup>
6	AUDIO GAIN Buttons	+ Press to increase the audio output level of the selected input <sup>2</sup>
7		- Press to decrease the audio output level of the selected input <sup>2</sup>

<sup>1</sup> If both the AUDIO and VIDEO buttons are lit, the unit operates in the audio-follow-video mode

<sup>2</sup> While the AUDIO button is lit

## Defining the VP-81KSi 8x1 UXGA/Audio STEP-IN Switcher

Figure 2 and Table 2 define the rear panel of the **VP-81KSi 8x1 UXGA/Audio STEP-IN Switcher**.

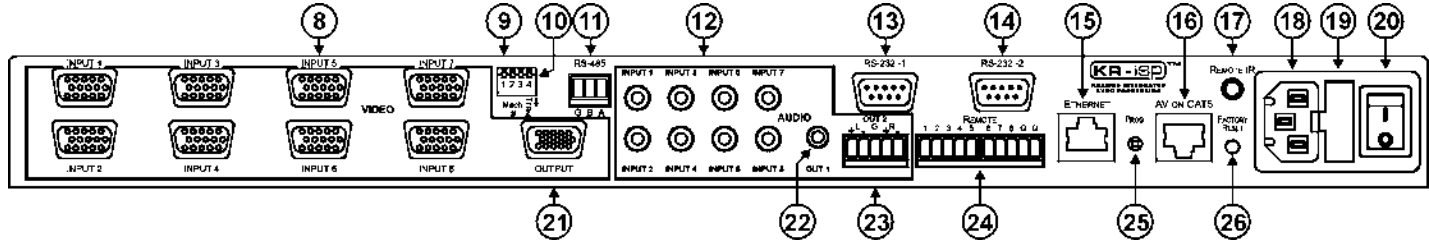

Figure 2: VP-81KSi 8x1 UXGA/Audio STEP-IN Switcher Rear Panel

Table 2: VP-81KSi 8x1 UXGA/Audio STEP-IN Switcher Rear Panel Features

#	Feature	Function
8	VIDEO INPUT 15-pin HD (F) Connectors	Connect to the VGA (up to WUXGA) sources (from 1 to 8)
9	Mach # DIP-switches	DIP-switches 1, 2 and 3 for assigning the RS-485 machine number (see Section 6.6.1)
10	TERM DIP-switch	DIP-switch 4 sets RS-485 termination on or off (see Section 6.6.1)
11	RS-485 Terminal Block	Connect to RS-485 port on a remote controller or another VP-81KSi (see Section 6.6)
12	AUDIO INPUT 3.5mm Mini Jacks	Connect to the unbalanced stereo audio sources (from 1 to 8)
13	RS-232-1 9-pin D-sub Port (F)	Connect to the RS-232 port on a remote controller (see Section 6.3)
14	RS-232-2 9-pin D-sub Port (M)	Connect to an RS-232 controllable device
15	ETHERNET RJ-45 Connector	Connect to a remote controller via a LAN (see Section 6.8)
16	AV ON CAT 5 RJ-45 Connector	Connect to a compatible TP receiver (for example, TP-122)
17	REMOTE IR 3.5mm Mini Jack	Connect to an external IR receiver unit for controlling the machine via an IR remote controller (see Section 4.1)
18	Mains Power Connector	Connect to the AC mains supply
19	Main Power Fuse	Fuse for protecting the unit
20	Mains Power Switch	AC mains switch
21	OUTPUT 15-pin HD Connector	Connect to the VGA (up to WUXGA) acceptor
22	AUDIO OUT 1 3.5mm Mini Jack	Connect to the unbalanced stereo audio acceptor
23	AUDIO OUT 2 Terminal Block Connector	Connect to the balanced stereo audio acceptor
24	REMOTE Switch Terminal Block	Connect to contact closure switches for duplicating the function of the front panel Input Selector buttons (see Section 6.2)
25	PROG. Button	For the use of Kramer technical support only
26	FACTORY RESET Button	Press and hold while turning the unit on to reset all parameters to factory default values (see Table 7)

## 4.1 Using the IR Transmitter for the VP-81KSi

You can use the **RC-IR3** IR transmitter to operate the machine via the built-in IR receiver on the front panel or, instead, via an optional external IR receiver<sup>1</sup>. The external IR receiver can be located 15m (49ft) away from the machine. This distance can be extended to up to 60m (197ft) when used with three extension cables<sup>2</sup>

Before using the external IR receiver, be sure to arrange for your Kramer dealer to insert the internal IR connection cable<sup>3</sup> with the 3.5mm jack that fits into the REMOTE IR opening on the rear panel. Connect the external IR receiver to the REMOTE IR 3.5mm jack.

---

1 Model: C-A35M/IRR-50

2 Model: C-A35M/A35F-50

3 P/N: 505-70434010-S

## 5 Installing in a Rack

This section describes the preparation and installation of the unit in a rack.

### Before Installing in a Rack

Before installing in a rack, be sure that the environment is within the recommended range:

Operating temperature range	+5° to +45° C (41° to 113° F)
Operating humidity range	10 to 90% RHL, non-condensing
Storage temperature range	-20° to +70° C (-4° to 158° F)
Storage humidity range	5 to 95% RHL, non-condensing



### CAUTION!

When installing on a 19" rack, avoid hazards by taking care that:

1. It is located within the recommended environmental conditions, as the operating ambient temperature of a closed or multi unit rack assembly may exceed the room ambient temperature.
2. Once rack mounted, enough air will still flow around the machine.
3. The machine is placed straight in the correct horizontal position.
4. You do not overload the circuit(s). When connecting the machine to the supply circuit, overloading the circuits might have a detrimental effect on overcurrent protection and supply wiring. Refer to the appropriate nameplate ratings for information. For example, for fuse replacement, see the value printed on the product label.
5. The machine is earthed (grounded) in a reliable way and is connected only to an electricity socket with grounding. Pay particular attention to situations where electricity is supplied indirectly (when the power cord is not plugged directly into the socket in the wall), for example, when using an extension cable or a power strip, and that you use only the power cord that is supplied with the machine.

### How to Rack Mount:

To rack-mount a machine:

1. Attach both ear brackets to the machine. To do so, remove the screws from each side of the machine (3 on each side), and replace those screws through the ear brackets.

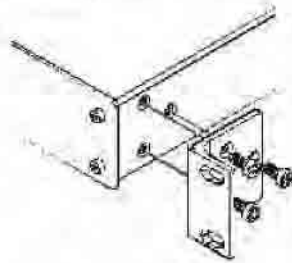

2. Place the ears of the machine against the rack rails, and insert the proper screws (not provided) through each of the four holes in the rack ears.

Note:

- In some models, the front panel may feature built-in rack ears
- Detachable rack ears can be removed for desktop use
- Always mount the machine in the rack before you attach any cables or connect the machine to the power
- If you are using a Kramer rack adapter kit (for a machine that is not 19"), see the Rack Adapters user manual for installation instructions available from: <http://www.kramerelectronics.com>

## 6 Connecting the VP-81KSi 8x1 UXGA/Audio STEP-IN Switcher

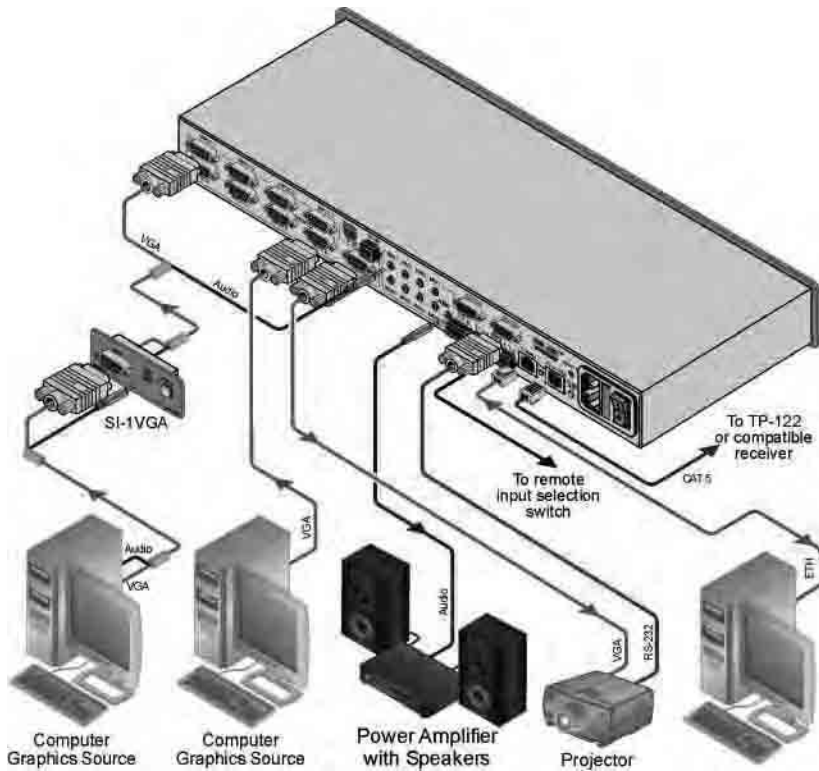

Figure 3: Connecting the VP-81KSi

To connect<sup>1</sup> the VP-81KSi, as illustrated in the example in Figure 3:

1. Connect up to eight<sup>2</sup> **SI-1VGA Remote Step-in Panels** to the **VP-81KSi** 15-pin HD VIDEO INPUT connectors<sup>3</sup> and to the 3.5mm mini jacks (from 1 to 8).
2. Connect up to eight WUXGA computer graphics sources to the **SI-1VGA** 15-pin HD video connectors.
3. Connect up to eight unbalanced audio sources to the 3.5mm mini jack audio connectors on the **SI-1VGA** panels.
4. Connect the 15-pin HD VIDEO OUTPUT connector to a WUXGA acceptor (for example, a projector).

1 Be sure that the power is switched off on each device before connecting it to your VP-81KSi. After connecting all the devices to your VP-81KSi, switch on the power of the VP-81KSi, and then switch on the power of each device.

2 You do not have to connect all the inputs.

3 The cable used must connect all 15 pins.

5. Connect the RJ-45 AV ON CAT 5 output connector to a compatible TP receiver (for example, TP-120).
6. Connect the unbalanced audio 3.5mm AUDIO OUTPUT jack to an unbalanced audio acceptor (for example, power amplifier).
7. Connect the balanced audio 5-pin terminal block (see [Section 6.1](#)) to an audio acceptor<sup>1</sup>.
8. Connect up to eight remote, contact closure input selection switches to the REMOTE terminal block (see [Section 6.2](#)).
9. Connect a PC over a LAN to the Ethernet for remote operation.
10. Set the DIP-switches (see [Section 6.6.1](#)) for remote operation. You can connect a PC and/or controller to the:
  - RS-232 port (see [Section 6.3](#))
  - RS-485 port (see [Section 6.6.1](#))
11. Connect<sup>1</sup> the power cord<sup>2</sup>.

## 6.1 Connecting the Balanced/Unbalanced Stereo Audio Output

This section illustrates how to wire the devices to the balanced audio output:

- A balanced stereo output connection, see [Figure 4](#)
- An unbalanced stereo output connection, see [Figure 5](#)

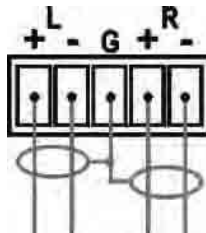

Figure 4: Balanced Stereo Audio Connection

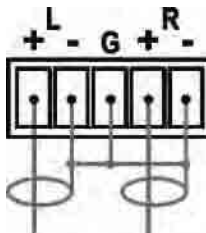

Figure 5: Unbalanced Stereo Audio Connection

---

<sup>1</sup> Not shown in the illustration

<sup>2</sup> We recommend that you use only the power cord that is supplied with this machine

## 6.2 Connecting Remote Contact Closure Input Selection Switches

You can connect remote input selection switches to the Remote terminal block on the rear panel of the **VP-81KSi** which enables you to remotely activate the relevant input.

The following example (see [Figure 6](#)) illustrates three switches (A, B and C) connected to remotely controlled inputs 1, 2 and 3 respectively (up to eight switches can be connected). Pressing switch A causes input 1 on the **VP-81KSi** to be the active input, pressing switch B causes input 2 to be the active input, and pressing switch C causes input 3 to be the active input.

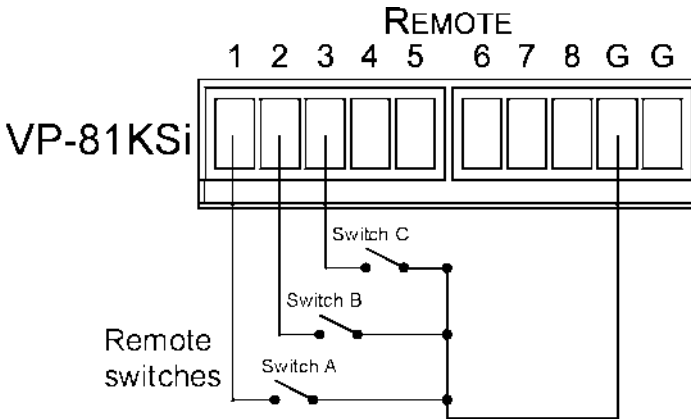

Figure 6: Remote Input Selection Switch Wiring

**To connect remote input selection switches as illustrated in the example in [Figure 6](#):**

1. Connect Switch A to pins 1 and G<sup>1</sup> on the terminal block.
2. Connect Switch B to pins 2 and G<sup>1</sup> on the terminal block.
3. Connect Switch C to pins 3 and G<sup>1</sup> on the terminal block.
4. If required, repeat for a total of up to eight switches.

## 6.3 Connecting the SI-1VGA Remote Step-in Module

For detailed instructions refer to the **SI-1VGA** Step-in Module Installation Instructions<sup>2</sup>.

**To connect an SI-1VGA remote step-in module to the VP-81KSi as illustrated in the example in [Figure 7](#):**

1. Mount the **SI-1VGA** in either the **TBUS-10** or the **K-POD301**.

<sup>1</sup> You can connect any of the switches to either of the two Gnd connections

<sup>2</sup> Available for download from <http://www.kramerelectronics.com>

2. Using a 15-pin HD (male to male) cable<sup>1</sup>, connect the 15-pin HD connector on the rear of the **SI-1VGA** to the corresponding input on the rear of the **VP-81KSi**.
3. Using an audio cable with 3.5mm mini jacks at both ends<sup>2</sup>, connect the 3.5mm mini connector on the rear of the **SI-1VGA** to the corresponding audio input on the rear of the **VP-81KSi**.
4. Repeat steps 2 and 3 for each **SI-1VGA** remote step-in module.

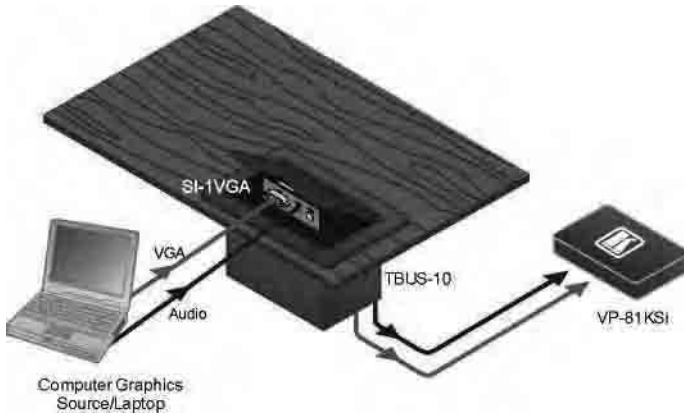

Figure 7: Connecting the SI-1VGA

#### 6.4 Connecting the AV ON CAT 5 Twisted Pair Output

You can connect the **VP-81KSi** to any compatible Kramer TP (Twisted Pair) receiver, for example, TP-120 (no audio) or TP-122 (with audio).

For further details, refer to the relevant TP receiver user manual<sup>3</sup>.

#### 6.5 Connecting to the VP-81KSi via the RS-232 Port

You can connect to the **VP-81KSi** via an RS-232 connection using, for example, a PC.

##### To connect to the VP-81KSi via RS-232:

- Connect the RS-232 9-pin D-sub rear panel port on the **VP-81KSi** unit via a 9-wire straight cable (pin 2 to pin 2, pin 3 to pin 3, pin 5 to pin 5) to the RS-232 9-pin D-sub port on your PC

---

<sup>1</sup> For example, Kramer C-GM/GM

<sup>2</sup> For example, Kramer C-A35M/A35M

<sup>3</sup> Available for download from <http://www.kramerelectronics.com>



## 6.6 Connecting to the VP-81KSi via the RS-485 Port

You can operate the **VP-81KSi** via the RS-485 port from a distance of up to 1200m (3900ft) using any device equipped with an RS-485 port (for example, a PC). For successful communication, you must set the RS-485 machine number and bus termination.

### To connect a device with a RS-485 port to the VP-81KSi:

- Connect the A (+) pin on the RS-485 port of the PC to the A (+) pin on the RS-485 port on the rear panel of the **VP-81KSi**
- Connect the B (–) pin on the RS-485 port of the PC to the B (–) pin on the RS-485 port on the rear panel of the **VP-81KSi**
- Connect the G pin on the RS-485 port of the PC to the G pin on the RS-485 port on the rear panel of the **VP-81KSi**

### 6.6.1 Setting the RS-485 Machine Number and Bus Termination DIP-switches

This section describes the **VP-81KSi** DIP-switch settings that determine the RS-485 machine number and bus termination.

Figure 8 illustrates the factory default DIP-switch positions.

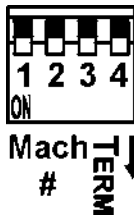

Figure 8: RS-485 DIP-switches

Table 3: RS-485 DIP-switch Settings

DIP-switch Number	Function
1, 2, 3	Machine number (see <a href="#">Table 4</a> ) Default—All off (up), machine number 1
4	RS-485 Bus Termination Default—Off (up)

DIP-switches 1, 2 and 3 determine the RS-485 machine number of the **VP-81KSi**. When several **VP-81KSi** units are connected, the machine number determines the unique identity of the **VP-81KSi** on the bus (see [Table 4](#)).

#### Note:

- When using a stand-alone **VP-81KSi** unit, set the machine number to 1 (factory default)
- When connecting more than one **VP-81KSi**, set the first machine (connected via RS-232) to be machine number 1. The other **VP-81KSi** units must each be set to a unique machine number between 2 and 16

Table 4: Machine Number DIP-switch Settings

Machine Number	1	2	3
1 (Default)	OFF	OFF	OFF
2	OFF	OFF	ON
3	OFF	ON	OFF
4	OFF	ON	ON
5	ON	OFF	OFF
6	ON	OFF	ON
7	ON	ON	OFF
8	ON	ON	ON

DIP-switch 4 sets the RS-485 bus termination of the **VP-81KSi**. Only the first and last physical units on the RS-485 bus must be terminated, all others must be unterminated. Moving the DIP-switch up turns the termination off (default), moving the switch down turns the termination on.

### 6.6.2 Connecting and Controlling Multiple VP-81KSi Devices

You can daisy-chain up to eight **VP-81KSi** devices with operation via RS-232 from a PC or serial controller.

#### To daisy-chain up to eight VP-81KSi devices:

1. Connect the RS-232 port<sup>1</sup> on the first **VP-81KSi** device to the PC (see [Section 6.3](#)).
2. Connect the RS-485 terminal block port on the first device to the RS-485 port on the second device, and so on for all devices.
3. Set the DIP-switches (see [Section 6.6.1](#)) as follows:
  - The first device is machine number 1 and the following seven devices are machine numbers 2 to 8
  - Terminate the first and last physical devices, that is, in this example terminate machine numbers 1 and 8. Ensure that all other devices are unterminated

### 6.7 Cascading Multiple VP-81KSi Devices

You can cascade up to eight **VP-81KSi** devices to build a single “virtual” switcher with up to 57 inputs and one output as illustrated in [Figure 9](#).

#### To cascade up to eight VP-81KSi devices:

1. Connect the output on the Master **VP-81KSi** to the video acceptor (for example, a projector).
2. Connect Input 1 on the Master **VP-81KSi** to the output of the second device.
3. Connect Input 1 on the second **VP-81KSi** to the output of the third device, and so on for all devices.

<sup>1</sup> Alternatively, the RS-485 port could be used for PC control

**Note:** Audio connections must follow the same connection scheme as the video connections.

4. Set the DIP-switches (see [Section 6.6.1](#)) as follows:

- The first device is machine number 1 (Master) and the following seven devices are machine numbers 2 to 8
- Terminate the first and last physical devices, that is, terminate machine numbers 1 and 8. Ensure that all other devices are unterminated

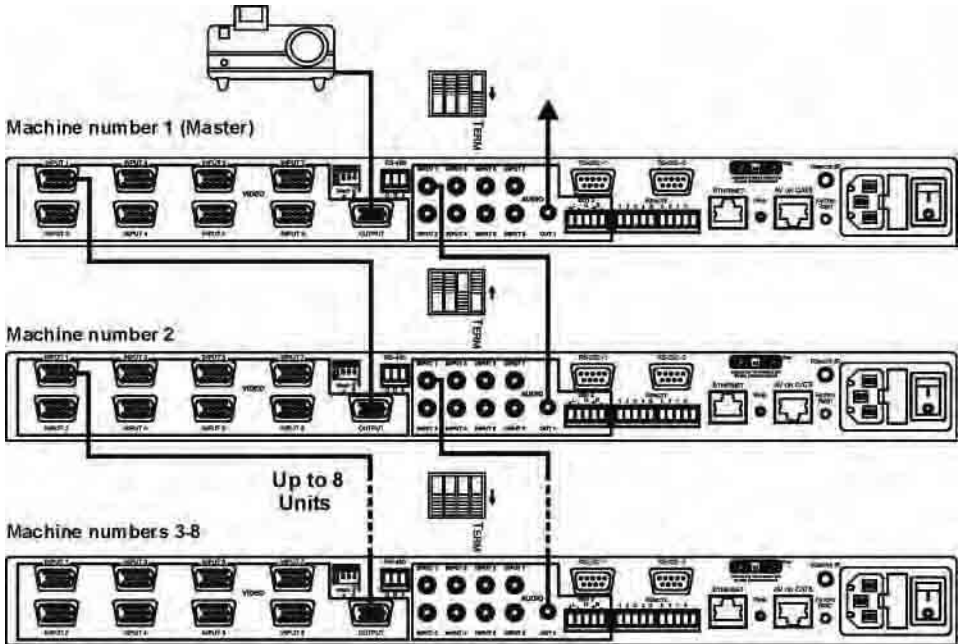

Figure 9: Cascading up to Eight VP-81KSi Devices

**Note:** The video acceptor must be connected to the Master output. The outputs of all other devices may be connected to any input on the subsequent device.

For operation of cascaded **VP-81KSi** devices, see [Section 7.4](#).

## 6.8 Connecting to the VP-81KSi via the Ethernet Port

You can connect the **VP-81KSi** via the Ethernet in the following ways:

- For direct connection to the PC, use a crossover cable (see [Section 6.8.1](#))
- For connection via a network hub or network router, use a straight through cable (see [Section 6.8.2](#))

**Note:** The following instructions are valid only if your PC uses a fixed IP address. If your PC receives an IP address from a DHCP server, consult your IT department regarding a suitable IP address.

### 6.8.1 Connecting Directly to the Ethernet Port

You can connect the Ethernet port of the **VP-81KSi** to the Ethernet port on your PC via a crossover cable with RJ-45 connectors.

This type of connection is recommended for identification of the factory default IP address of the **VP-81KSi** during the initial configuration

**To connect the VP-81KSi directly to a PC:**

1. Using a crossover cable, connect the **VP-81KSi** to the PC via the Ethernet port on both units.
2. On the PC, click **Start > Control Panel**.
3. Double-click **Network Connections**.
4. Right-click, and from the menu select **Properties**.  
The **Local Area Connection Properties** window appears.

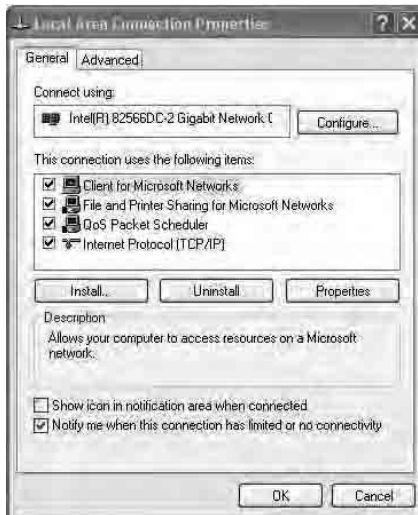

Figure 10: Local Area Connection Properties Window

5. Select **Internet Protocol (TCP/IP)** (see [Figure 10](#)).
6. Click the **Properties** button.
7. Select **Use the following IP address**, and fill in the details as shown in [Figure 11](#).

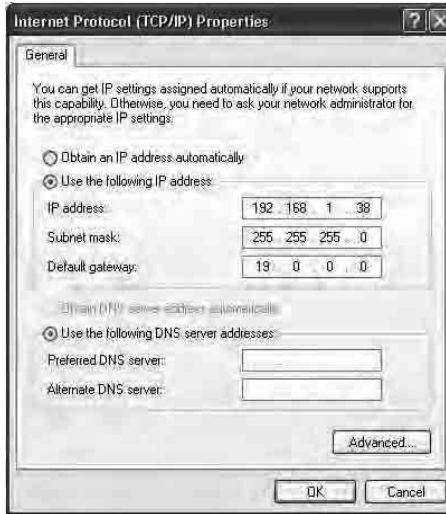

Figure 11: Internet Protocol (TCP/IP) Properties Window

8. Click **OK**.

### 6.8.2 Connecting via a Network Hub, Switch, or Router

You can connect the Ethernet port of the **VP-81KSi** to the Ethernet port on a network hub, switch, or router, via a straight through cable with RJ-45 connectors. The **VP-81KSi** Ethernet port has to be configured to be compatible with your network (see [Section 6.8.3](#)).

### 6.8.3 Configuring the Ethernet Port on the VP-81KSi

To configure the Ethernet port on the **VP-81KSi**, download the **P3K Ethernet Configuration** software<sup>1</sup> to your PC, extract the files to a folder, and install the software.

**To configure the VP-81KSi Ethernet port:**

1. Click **Start > All Programs > Kramer > P3K Wizard**  
The **P3K Wizard** window appears.
2. Click **Connect**.  
The **Connect** window appears.

<sup>1</sup> Available from <http://www.kramerelectronics.com>

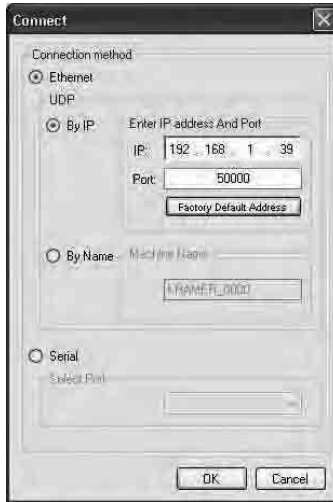

Figure 12: Connect Window

3. Select one of the following methods to connect to the Ethernet port of the **VP-81KSi**:
  - Ethernet, if you are connected via an Ethernet cable. Enter the IP address<sup>1</sup> or the machine name  
The default IP address is 192.168.1.39 and the default name for the unit is KRAMER\_XXXX<sup>2</sup>
  - Serial, if you are connected via a serial port. Select the COM port from the Select Port drop-down list.
4. Click **OK**.  
The **Device Properties** window appears.

---

<sup>1</sup> The default IP address is 192.168.1.39

<sup>2</sup> The four digits are the last four digits of the machine's serial number

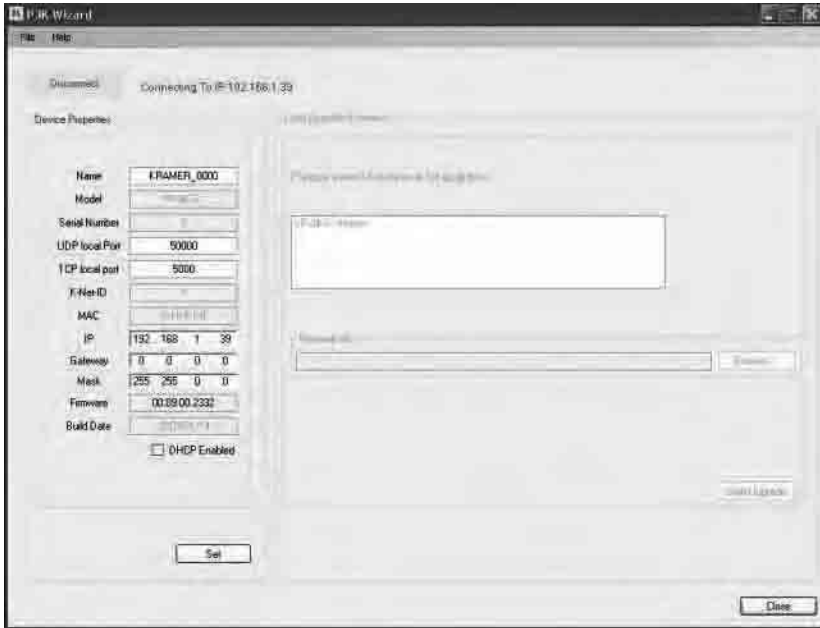

Figure 13: Device Properties Window

5. Make the required changes.
6. Click **Set** to save changes, or click **Close** to exit and not save the changes.

## 7 Operating the VP-81KSi Locally via the Front Panel Buttons

Powering up the **VP-81KSi** recalls the previous settings (that is, the state of the unit when it was powered down) from the non-volatile memory.

### 7.1 Using the Front Panel INPUT SELECTOR Buttons

[Table 5](#) describes the input selector button illumination descriptions.

Table 5: Button Illumination Descriptions

Button Color	Selected	Input Signal
Red	Yes	No
Green	No	Yes
Violet	Yes	Yes

To switch an input to the outputs, press one of the eight front panel INPUT SELECTOR buttons. The INPUT SELECTOR button lights (see [Table 5](#)) and switches the input simultaneously to both the VGA and AV ON CAT 5 TP outputs.

### 7.2 Using the Audio-Follow-Video/Breakaway Modes

By default, the **VP-81KSi** switches in AFV (Audio-Follow-Video) mode in which

all operations relate to both the video and audio. When in this mode, both the VIDEO and the AUDIO buttons are lit.

### 7.2.1 Operating in Breakaway Mode

**To operate in breakaway mode in which video and audio channels switch independently:**

- Press either the VIDEO button or the AUDIO button.  
If the VIDEO button lights, the switching relates just to video (and the audio remains unchanged)  
If the AUDIO button lights, the switching relates only to audio (and the video remains unchanged)

### 7.2.2 Switching to Audio Follow Video Mode

**To switch to AFV (Audio Follow Video) mode:**

- Press the VIDEO and the AUDIO buttons simultaneously

### 7.3 Setting the Audio Output Gain

You can set the audio output gain using the AUDIO GAIN + and - buttons.

**To set the audio output gain:**

1. Press an input button.  
The input button lights.
2. Press either the AUDIO GAIN + (to increase) or AUDIO GAIN – (to decrease) button to vary the gain.

### 7.4 Operating Cascaded VP-81KSi Devices

Selecting an input on a device selects the required input and automatically selects the interconnected input on the subsequent device.

Given the example illustrated in [Figure 9](#), pressing Input 4 on device 2, selects Input 4 on device 2 and automatically selects Input 1 on the Master device.

Pressing Input 5 button on device 8 selects Input 5 on device 8 and automatically selects Input 1 on all subsequent devices.



## 8 Operating the VP-81KSi Remotely

You can operate the **VP-81KSi** remotely using the **Kramer K-Single Control Software** on a PC. For full details, see the **Kramer Control Software *Online Guide***.

The **VP-81KSi** can be operated remotely via any of the following methods:

- The Kramer **RC-IR3** Infra-Red Remote Control transmitter
- Contact closure switches (for connecting, see [Section 6.2](#))
- **SI-1VGA Remote Step-in Panel** (for connecting, see [Section 6.3](#))
- RS-232 (for connecting, see [Section 6.4](#))
- RS-485 (for connecting, see [Section 6.6](#))
- Ethernet over a LAN using a Web browser (see [Section 9](#))

## 9 Operating the VP-81KSi Remotely using a Web Browser

The embedded Web pages can be used to remotely operate the **VP-81KSi** using a Web browser and an Ethernet connection.

Before attempting to connect:

- Perform the procedures in [Section 6.8](#).
- Ensure that the Java™ software is installed and functioning correctly on your computer. If not, download it from [www.java.com](http://www.java.com)
- Ensure that your browser is supported—Microsoft IE (V6.0 and higher), Google Chrome, Firefox (V3.0 and higher).

To check that Java is installed and running correctly, browse to <http://www.java.com/en/download/help/testvm.xml>

This page runs a test and displays a Java success (see [Figure 14](#)) or failure message.



*Figure 14: Java Test Page Success Message*

If you do not see the success message, follow the instructions on the page to:

- Load and enable Java

- Enable Javascript in your browser

## 9.1 To Log On to the VP-81KSi Web Pages

**To log on to VP-81KSi Web pages:**

1. Open your Internet browser.
2. Type the unit's IP number (see [Table 7](#)) in the Address bar of your browser.



The **Loading** page appears.



*Figure 15: The Loading Page*

The first time that you run the program, the Warning-Security screen appears.



Figure 16: First Time Security Warning

3. Click **Run**.

The main switching control Home page is displayed which shows a graphical interpretation of the front panel (see [Figure 17](#)).

The Web pages let you control the **VP-8x8AK** via the Ethernet. The menu appears on the left side of the screen. There are three remote operation Web pages:

- The switching matrix (see [Section 9.2](#))
- Audio gain control (See [Section 9.3](#))
- Configuration (See [Section 9.4](#))

A description of each Web page is displayed if you hover your mouse over the question mark  that appears on the left side of the screen.

## 9.2 The Switching Matrix Page

The **VP-81KSi** switching matrix page lets you route any or all of the eight inputs to the output by clicking the audio and/or video signal indicators (purple and blue, respectively).

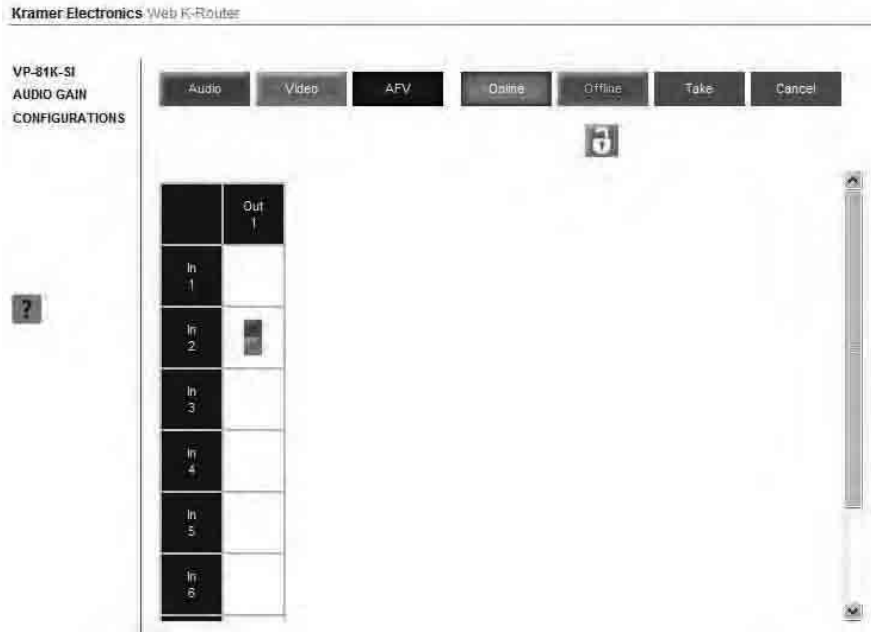



Figure 17: VP-81KSi Switching Matrix Page

You can perform the following operations via this Web page:

- Operate in the AFV mode or switch the audio and video separately, by clicking the **Audio**, **Video** or **AFV** buttons (see [Section 9.2.1](#))
- Select an audio and/or video signal<sup>1</sup> by clicking that signal indicator
- Operate in the At Once or Confirm mode (see [Section 9.2.2](#))
- Click the lock icon  to lock or unlock the front panel

### 9.2.1 Switching an Input to an Output

**To switch an input to an output (for example, input 4 to output 1):**

1. Click on the dark blue **AFV** mode button. (To switch only the video or audio channel, click on purple **Audio** or blue **Video** button respectively.)  
The border of the button turns dark.
2. Click on the switching point within the matrix (In 4 to Out 1).  
The audio/video signal indicators move to the In 4 to Out 1 switching matrix box, indicating that In 4 is now switched to Out 1.

<sup>1</sup> Depending on the operation mode (Audio, Video or AFV)

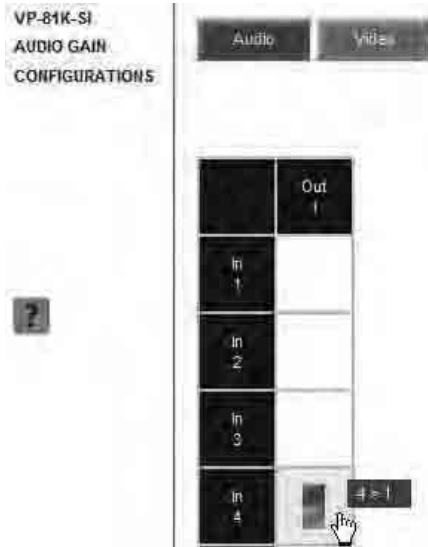

Figure 18: Switching an Input to an Output

### 9.2.2 Operating in the Confirm Mode

By default, the device is set to the At-Once mode.

**To operate in the Confirm mode:**

1. Click the red **Offline** button.  
The border of the button turns dark.
2. Click the desired switching-point in the switching matrix.  
Audio/video indicator outlines appear on the matrix and the **Take** and **Cancel** buttons turn blue.

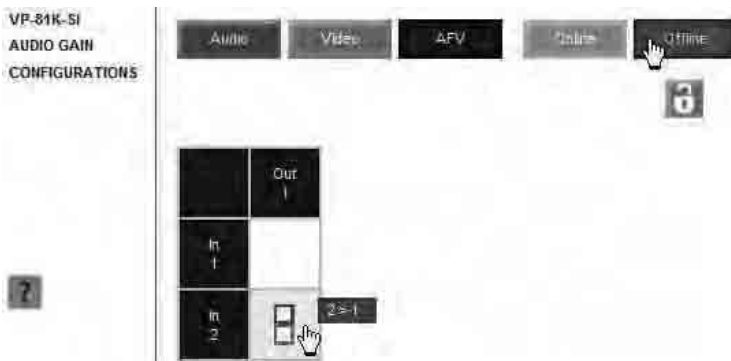

Figure 19: Switching an Input to an Output

3. Click either **Take** to accept the changes or **Cancel** to abandon them.

4. Click the **Online** button to exit the Confirm mode.

If you click the **Online** button before you click the **TAKE** button, the following warning shown in [Figure 20](#) appears.

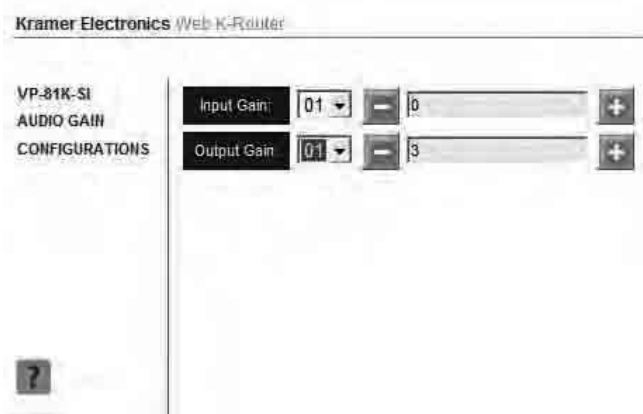

*Figure 20: Exiting Offline Warning*

Clicking **OK** cancels all changes made. Clicking **Cancel** returns you to the switching matrix screen with the changes made but not saved.

### 9.3 The Audio Gain Page

The Audio Gain screen lets you set the gain for each of the input and the output channels.



*Figure 21: Audio Gain Page*

#### To change an input or output gain:

1. Using the Input Gain or Output Gain drop-down list, select the channel number.
2. Click and hold the + or – button to increase or decrease the gain respectively. Each click on the + or – button increases/decreases the audio gain by 0.5 units.

## 9.4 The Configurations Page

The Configurations page lets you view some Ethernet settings and change others (see [Figure 22](#)). Fields with a white background are editable; fields with a blue background are read-only.

To change the configuration definitions:

1. Click **CONFIGURATIONS**.  
The Configurations Web page appears.
2. Modify the values as required.
3. Click the blue **Submit** button to apply changes or **Cancel** to abandon them.  
A confirmation window appears asking if you are sure you want to change the network settings.
4. Click **Yes**.  
A window appears informing you that the configuration has been successfully changed.
5. Click **OK**.
6. If the IP address has been changed, close your browser and reload the Web page using the new IP address.

Kramer Electronics web-K-Router	
VP-81K-SI	Name: KRAMER_0000
AUDIO GAIN	Model: VP-81KSI
<b>CONFIGURATIONS</b>	Serial Number: 0
	Firmware version: 00.09.00.3290
	MAC Address: ff-ff-ff-ff-ff-ff
	IP Address: 192.168.001.039
	DHCP: <input type="checkbox"/>
	Gateway: 000.000.000.000
	Subnet Mask: 255.255.000.000
	<b>Submit</b> <b>Cancel</b>

Figure 22: Configurations Page

## 10 Upgrading the Firmware

For instructions on upgrading the firmware, see the document *Updating the VP-81KSi Firmware Using P3K Software*.

The latest version of firmware and installation instructions can be downloaded from the Kramer Web site at [www.kramerelectronics.com](http://www.kramerelectronics.com).

## 11 EDID

Each input on the **VP-81KSi** has a factory default EDID loaded (see [Section 14](#)). The EDID for each input can be changed independently by uploading an EDID binary file to each input via the RS-232 port using Kramer EDID Sender software<sup>1</sup>.

---

<sup>1</sup> Available for download from <http://www.kramerelectronics.com>



## 12 Technical Specifications

Table 6 lists the technical specifications<sup>1</sup> of the **VP-81KSi**.

*Table 6: Technical Specifications of the VP-81KSi*

INPUTS:	8 XGA on 15-pin HD (F) connectors 8 Unbalanced stereo audio on 3.5mm mini jacks	
OUTPUTS:	1 XGA on 15-pin HD connector 1 TP on RJ-45 connector 1 unbalanced stereo audio on a 3.5mm mini jack 1 balanced audio stereo on a 5-pin detachable terminal block	
MAX. OUTPUT LEVEL:	VIDEO: 2Vpp	AUDIO: Stereo Unbalanced 7.8Vpp Stereo Balanced 15.6Vpp differential
BANDWIDTH (-3dB):	VIDEO: Out 440MHz CAT 5 (Rec Out) 150MHz	AUDIO: Stereo Unbalanced 20KHz Stereo Balanced 20KHz
RESOLUTION:	VIDEO: VGA up to WUXGA	
DIFF. GAIN:	VIDEO: XGA 0.04%	
DIFF. PHASE:	VIDEO: UXGA: 0.07Deg	
K FACTOR:	VIDEO: UXGA 0 2%	
S/N RATIO:	VIDEO: UXGA 68.3dB @5MHz	AUDIO: Stereo Unbalanced 74dB @1KHz Stereo Balanced 74.4dB @1kHz CAT5 (Rec Out) 69.8dB
CROSSTALK (all hoses):	VIDEO: UXGA -52dB @5MHz	AUDIO: Local Stereo Unbalanced -73dB @1KHz Local Stereo Balanced <72dB @1kHz
VOLUME CONTROL:	AUDIO: Stereo Unbalanced -65.4 to 25.8dB Stereo Balanced -59.4 to 31.8dB	
COUPLING:	VIDEO: UXGA—DC TP Out—DC	AUDIO: Stereo Unbalanced—In AC, Out DC Stereo Balanced—In AC, Out DC
AUDIO THD + NOISE:	Stereo Unbalanced 0.08% Stereo Balanced 0.08%	
AUDIO 2nd HARMONIC:	Stereo Unbalanced 0.001% Stereo Balanced 0.001%	
POWER SOURCE:	100-240V AC 50/60Hz 29VA	
DIMENSIONS:	43.6cm x 19.1cm x 4.4cm (19" x 7 5" x 1U) W, D, H rack-mountable	
WEIGHT:	1.7kg (3 8lbs) approx.	
ACCESSORIES:	Power cord, Windows®-based Kramer control software, RC-IR3 Infrared Remote Control transmitter, one SI-1VGA Remote Step-in module	
OPTIONS:	External remote IR receiver cable <sup>2</sup> ; 15m extension cable <sup>3</sup> ; SI-1VGA Remote Step-in Module	

<sup>1</sup> Specifications are subject to change without notice

<sup>2</sup> P/N: C-A35M/IRR-50

<sup>3</sup> P/N: C-A35M/A35F-50

## 13 Communication Parameters

Table 7 lists the communication parameters as used in Kramer Electronics products.

Table 7: Communication Parameters

RS-232			
Protocol 2000		Protocol 3000 (Default)	
Baud Rate:	9600	Baud Rate:	115,200
Data Bits:	8	Data Bits:	8
Stop Bits:	1	Stop Bits:	1
Parity:	None	Parity:	None
Command Format:	HEX	Command Format:	ASCII
Example (Output 1 to Input 1):	0x01, 0x81, 0x81, 0x81	Example (Output 1 to Input 1):	#AV 1>1<CR>
Switching Protocol			
P2000 -> P3000		P3000 -> P2000	
Command:	0x38, 0x80, 0x83, 0x81	Command:	#P2000<CR>
Front Panel:	Press and hold Output 1 and Output 3 simultaneously	Front Panel:	Press and hold Output 1 and Output 2 simultaneously
Ethernet Factory Default Values			
IP Address: 192.168.1.39	Power cycle the unit while pressing the Factory Reset button, located on the rear panel of the unit.		
Mask: 255.255.255.0			
Gateway: 192.168.1.1			
TCP Port #: 5000			
UDP Port #: 50000			

## 14 Default EDID

The default EDID is stored in all inputs.

### Monitor

Model name..... VP-81K-SI  
 Manufacturer..... KRM  
 Plug and Play ID..... KRM0808  
 Serial number..... 2  
 Manufacture date..... 2009, ISO week 10

EDID revision..... 1.3  
 Input signal type..... Analog 0.700,0 000 (0.7V p-p)  
 Sync input support..... Separate, Composite, Sync-on-green  
 Display type..... RGB color  
 Screen size..... 360 x 290 mm (18.2 in)  
 Power management..... Standby, Suspend, Active off/sleep  
 Extension blocs..... None  
 DDC/CI..... Not supported

### Color characteristics

Default color space..... sRGB  
 Display gamma..... 2.00  
 Red chromaticity..... Rx 0.611 - Ry 0.329  
 Green chromaticity..... Gx 0.312 - Gy 0.559  
 Blue chromaticity..... Bx 0.148 - By 0.131  
 White point (default).... Wx 0.320 - Wy 0.336  
 Additional descriptors... None

### Timing characteristics

Range limits..... Not available

## Table of ASCII Codes for Serial Communication (Protocol 3000)

GTF standard..... Not supported  
 Additional descriptors... None  
 Preferred timing..... Yes  
 Native/preferred timing.. 1024x768p at 60Hz (4:3)  
 Modeline..... "1024x768" 65.000 1024 1048 1184 1344 768 771 777 806 -hsync -vsync  
 Detailed timing #1..... 1280x800p at 60Hz (1:1)  
 Modeline..... "1280x800" 71.000 1280 1328 1360 1440 800 803 809 823 +hsync -vsync

Standard timings supported  
 640 x 480p at 60Hz - IBM VGA  
 640 x 480p at 67Hz - Apple Mac II  
 640 x 480p at 72Hz - VESA  
 640 x 480p at 75Hz - VESA  
 800 x 600p at 56Hz - VESA  
 800 x 600p at 60Hz - VESA  
 800 x 600p at 72Hz - VESA  
 800 x 600p at 75Hz - VESA  
 1024 x 768p at 60Hz - VESA  
 1024 x 768p at 70Hz - VESA  
 1024 x 768p at 75Hz - VESA  
 1280 x 1024p at 75Hz - VESA  
 1280 x 1024p at 60Hz - VESA STD  
 1280 x 960p at 60Hz - VESA STD  
 1400 x 1050p at 60Hz - VESA STD  
 1440 x 900p at 60Hz - VESA STD  
 1600 x 1200p at 60Hz - VESA STD  
 1920 x 1200p at 60Hz - VESA STD  
 1920 x 1080p at 60Hz - VESA STD

Report information  
 Date generated..... 12/7/2010  
 Software revision..... 2.43.0.822  
 Operating system..... 5.1.2600.2.Service Pack 3

Raw data  
 00,FF,FF,FF,FF,FF,FF,00,2E,4D,08,08,02,00,00,00,0A,13,01,03,6E,24,1D,64,EE,9C,20,9C,54,4F,8F,26,21,52,56,  
 3F,CF,00,81,80,81,40,90,40,95,00,A9,40,D1,00,D1,C0,01,01,64,19,00,40,41,00,26,30,18,88,36,00,30,E4,10,00,00,  
 18,BC,1B,00,A0,50,20,17,30,30,20,36,00,20,20,00,00,00,1A,00,00,00,FC,00,56,50,2D,38,31,4B,2D,53,49,0A,20,20,  
 20,00,00,00,10,00,56,50,2D,38,31,4B,2D,53,49,20,0A,20,20,00,68

## 15 Table of ASCII Codes for Serial Communication (Protocol 3000)

Table 8 lists the ASCII values to switch an input to an output for a single **VP-81KSi** device. For more detailed information, see Protocol 3000 Section 17.2.

*Table 8: VP-81KSi Video and Audio Signal Codes*

	Video	Audio
<b>IN 1</b>	#V 1>1 <span style="border: 1px solid black; padding: 0 2px;">CR</span>	#A 1>1 <span style="border: 1px solid black; padding: 0 2px;">CR</span>
<b>IN 2</b>	#V 2>1 <span style="border: 1px solid black; padding: 0 2px;">CR</span>	#A 2>1 <span style="border: 1px solid black; padding: 0 2px;">CR</span>
<b>IN 3</b>	#V 3>1 <span style="border: 1px solid black; padding: 0 2px;">CR</span>	#A 3>1 <span style="border: 1px solid black; padding: 0 2px;">CR</span>
<b>IN 4</b>	#V 4>1 <span style="border: 1px solid black; padding: 0 2px;">CR</span>	#A 4>1 <span style="border: 1px solid black; padding: 0 2px;">CR</span>
<b>IN 5</b>	#V 5>1 <span style="border: 1px solid black; padding: 0 2px;">CR</span>	#A 5>1 <span style="border: 1px solid black; padding: 0 2px;">CR</span>
<b>IN 6</b>	#V 6>1 <span style="border: 1px solid black; padding: 0 2px;">CR</span>	#A 6>1 <span style="border: 1px solid black; padding: 0 2px;">CR</span>
<b>IN 7</b>	#V 7>1 <span style="border: 1px solid black; padding: 0 2px;">CR</span>	#A 7>1 <span style="border: 1px solid black; padding: 0 2px;">CR</span>
<b>IN 8</b>	#V 8>1 <span style="border: 1px solid black; padding: 0 2px;">CR</span>	#A 8>1 <span style="border: 1px solid black; padding: 0 2px;">CR</span>

Table 9 lists the codes that set the audio input gain. For more detailed information, see Section 17.2.

Table 9: VP-81KSi Audio Input Gain Codes

INPUT 1		INPUT 5		INPUT X*	Level [Rel]
#AUD-LVL 1,1, -63 $\overline{\text{CR}}$	...	#AUD-LVL 1,5, -63 $\overline{\text{CR}}$	...	#AUD-LVL 1,X, -63 $\overline{\text{CR}}$	-63dB Mute
⋮		⋮		⋮	
#AUD-LVL 1,1, -50 $\overline{\text{CR}}$	...	#AUD-LVL 1,5, -50 $\overline{\text{CR}}$	...	#AUD-LVL 1,X, -50 $\overline{\text{CR}}$	-50dB
⋮		⋮		⋮	
#AUD-LVL 1,1, 0 $\overline{\text{CR}}$	...	#AUD-LVL 1,5, 0 $\overline{\text{CR}}$	...	#AUD-LVL 1,X, 0 $\overline{\text{CR}}$	0dB
⋮		⋮		⋮	
#AUD-LVL 1,1, 7 $\overline{\text{CR}}$	...	#AUD-LVL 1,5, 7 $\overline{\text{CR}}$	...	#AUD-LVL 1,X, 7 $\overline{\text{CR}}$	+7dB (Max)

\* Where X is the input number from 1 - 8. For example, for channel 7 and relative level -50dB, #AUD-LVL 1,7, -50 $\overline{\text{CR}}$

Table 10 lists the codes that set the video and audio output gain. For more detailed information, see Section 17.1.2.

Table 10: VP-81KSi Audio and Audio Output Gain Codes

OUTPUT 1	Level [Rel]
#AUD-LVL 2,1, -30 $\overline{\text{CR}}$	-30dB
⋮	
#AUD-LVL 2,1, 0 $\overline{\text{CR}}$	0dB
⋮	
#AUD-LVL 2,1, 20 $\overline{\text{CR}}$	+20dB

## 16 Table of Hex Codes for Serial Communication (Protocol 2000)

Table 11 lists the Hex values to switch an input to an output for a single VP-81KSi machine. For more detailed information, see Protocol 2000<sup>1</sup> (see Section 17.3).

Table 11: VP-81KSi Hex Codes for Protocol 2000

	Video	Audio
<b>IN 1</b>	01, 81, 81, 81	02, 81, 81, 81
<b>IN 2</b>	01, 82, 81, 81	02, 82, 81, 81
<b>IN 3</b>	01, 83, 81, 81	02, 83, 81, 81
<b>IN 4</b>	01, 84, 81, 81	02, 84, 81, 81
<b>IN 5</b>	01, 85, 81, 81	02, 85, 81, 81
<b>IN 6</b>	01, 86, 81, 81	02, 86, 81, 81
<b>IN 7</b>	01, 87, 81, 81	02, 87, 81, 81
<b>IN 8</b>	01, 88, 81, 81	02, 88, 81, 81

Table 12 lists the Hex codes that increase or decrease audio input gain.

Table 12: VP-81KSi Hex Codes that Increase/Decrease Audio Input Gain

<sup>1</sup> Go to the Technical Support section of our Web site at <http://www.kramerelectronics.com>

Table of Hex Codes for Serial Communication (Protocol 2000)

	IN 1	IN 2	IN 3	IN 4	IN 5	IN 6	IN 7	IN 8
Increase	18 81 86 81	18 82 86 81	18 83 86 81	18 84 86 81	18 85 86 81	18 86 86 81	18 87 86 81	18 88 86 81
Decrease	18 81 87 81	18 82 87 81	18 83 87 81	18 84 87 81	18 85 87 81	18 86 87 81	18 87 87 81	18 88 87 81

Table 13 lists the Hex codes that set the audio input gain.

**Note:** Before sending any of the codes in Table 13, the command 2A 86 80 81 must be sent.

Table 13: Hex Codes that Set the Audio Input Gain

IN 1	IN 2	IN 3	IN 4	IN 5	IN 6	IN 7	IN 8	Level [Rel]
16 81 80* 81	16 82 80* 81	16 83 80* 81	16 84 80* 81	16 85 80* 81	16 86 80* 81	16 87 80* 81	16 88 80* 81	-63dB Mute
⋮	⋮	⋮	⋮	⋮	⋮	⋮	⋮	
16 81 8D 81	16 82 8D 81	16 83 8D 81	16 84 8D 81	16 85 8D 81	16 86 8D 81	16 87 8D 81	16 88 8D 81	-50dB
⋮	⋮	⋮	⋮	⋮	⋮	⋮	⋮	
16 81 BF 81	16 82 BF 81	16 83 BF 81	16 84 BF 81	16 85 BF 81	16 86 BF 81	16 87 BF 81	16 88 BF 81	0dB
⋮	⋮	⋮	⋮	⋮	⋮	⋮	⋮	
16 81 C6 81	16 82 C6 81	16 83 C6 81	16 84 C6 81	16 85 C6 81	16 86 C6 81	16 87 C6 81	16 88 C6 81	+7dB (Max)

\* BYTE 3 = 0x80 + Gain Value (0x00-0x46)

Table 14 lists the Hex codes that increase or decrease the audio output gain.

Table 14: VP-8x8AK Hex Codes for Increasing/Decreasing the Output Gain

	OUT 1	OUT 2	OUT 3	OUT 4	OUT 5	OUT 6	OUT 7	OUT 8
Increase	18 81 80 81	18 82 80 81	18 83 80 81	18 84 80 81	18 85 80 81	18 86 80 81	18 87 80 81	18 88 80 81
Decrease	18 81 81 81	18 82 81 81	18 83 81 81	18 84 81 81	18 85 81 81	18 86 81 81	18 87 81 81	18 88 81 81

Table 15 lists the Hex codes that set the audio output gain.

Before sending the any of the codes in Table 15, the command 2A 87 80 81 must be sent.

Table 15: Hex Codes for Setting the Audio Output Gain

OUT 1	Level [Rel]
16 81 80* 81	-30dB
⋮	
16 81 9E 81	0dB
⋮	
16 81 B2 81	+20dB

\*BYTE 3 = 0x80 + Gain Value (0x00-0x32)

## 17 Kramer Protocol

Section 17.1 describes how to switch between Protocol 3000 and Protocol<sup>1</sup> 2000. By default, the **VP-81KSi** is set to protocol 3000 (see Section 17.2) but is also compatible with Kramer's Protocol 2000 (see Section 17.3).

### 17.1 Switching Protocols

You can switch protocols either via the front panel buttons (see Section 17.1.1) or the protocol commands (see Section 17.1.2).

#### 17.1.1 Switching Protocols via the Front Panel Buttons

To switch from protocol 3000 to protocol 2000 via the:

- Front panel buttons, press the IN 1 and IN 2 button simultaneously
- Infrared remote control transmitter, press the TAKE button and then 13

To switch from protocol 2000 to protocol 3000 via the:

- Front panel buttons, press the IN 1 and IN 3 button simultaneously
- Infrared remote control transmitter, press the TAKE button and then 16

#### 17.1.2 Switching Protocols via Protocol Commands

To switch from protocol 3000 to protocol 2000, send the following command:

**#P2000<CR>**

To switch from protocol 2000 to protocol 3000, send the following command:

**0x38, 0x80, 0x83, 0x81**

The Windows<sup>®</sup>-based Kramer control software<sup>2</sup> operates with Protocol 2000. If the **VP-81KSi** is set to Protocol 3000, it is automatically switched to Protocol 2000.

## 17.2 Kramer Protocol 3000

This RS-232/RS-485 communication protocol lets you control the machine from any standard terminal software (for example, Windows<sup>®</sup> HyperTerminal Application).

<sup>1</sup> You can download our user-friendly "Software for Calculating Hex Codes for Protocol 2000" from the technical support section at <http://www.kramerelectronics.com>

<sup>2</sup> Download the latest software from our Web site at <http://www.kramerelectronics.com>

### 17.2.1 Protocol 3000 Syntax

Host message format:

Start	Address (optional)	Body	Delimiter
#	<i>Destination_id@</i>	message	CR

Simple command (commands string with only one command without addressing):

start	body	delimiter
#	Command SP Parameter_1,Parameter_2,...	CR

Commands string (formal syntax with commands concatenation and addressing):

# *Address@* **Command\_1** *Parameter1\_1,Parameter1\_2,... |Command\_2  
Parameter2\_1,Parameter2\_2,... |Command\_3 Parameter3\_1,Parameter3\_2,...  
|...CR*

Device message format:

Start	Address (optional)	Body	Delimiter
~	<i>Sender_id@</i>	message	CR LF

Device long response (**Echoing command**):

Start	Address (optional)	Body	Delimiter
~	<i>Sender_id@</i>	<b>command</b> SP [ <i>param1 ,param2 ...</i> ] result	CR LF

CR = Carriage return (ASCII 13 = 0x0D)

LF = Line feed (ASCII 10 = 0x0A)

SP = Space (ASCII 32 = 0x20)

### 17.2.2 Command Part Details

**Command:**

Sequence of ASCII letters ('A'-'Z', 'a'-'z' and '-')

Command will separate from parameters with at least single space

**Parameters:**

Sequence of Alfa-Numeric ASCII chars ('0'-'9','A'-'Z','a'-'z' and some special chars for specific commands), parameters will be separated by commas

**Message string:**

Every command must be entered as part of message string that begin with **message starting char** and end with **message closing char**, note that string can contain more then one command separated by pipe ("|") char

**Message starting char:**

# for host command/query

~ for machine response

**Device address** (Optional, for Knet):

Knet Device ID follow by '@' char

**Query sign** = '?', will follow after some commands to define query request

Message closing char =

Host messages - Carriage Return (ASCII 13), will be referred to by **CR** in this document

Machine messages - Carriage Return (ASCII 13) + Line-Feed (ASCII 10), will be referred to by **CRLF**

Spaces between parameters or command parts will be ignored

**Commands chain separator char:**

When **message string** contains more than one command, commands will be separated by pipe ("|")

**Commands entering:**

If terminal software used to connect over serial \ ethernet \ USB port, that possible to directly enter all commands characters (**CR**) will be entered by Enter key, that key send also **LF**, but this char will be ignored by commands parser)

Sending commands from some controllers (like Crestron) require coding some characters in special form (like \X##) Anyway, there is a way to enter all ASCII characters, so it is possible to send all commands also from controller

(Similar way can use for URL \ Telnet support that maybe will be added in future)

**Commands forms:**

Some commands have short name syntax beside the full name to allow faster typing, response is always in long syntax

**Commands chaining:**

It is possible to enter multiple commands in same string by '|' char (pipe)

In this case the **message starting char** and the **message closing char** will be entered just one time, in the string beginning and at the end

All the commands in string will not execute until the closing char will be entered

Separate response will be sent for every command in the chain

**Input string max length:**

64 characters

**Backward support:**

Design note: transparent supporting for protocol 2000 will be implemented by switch protocol command from protocol 3000 to protocol 2000, in protocol 2000 there is already such a command to switch protocol to ASCII protocol (#56 : H38 H80 H83 H81)

*Table 16: Instruction Codes for Protocol 3000*

Help commands		
Command	Syntax	Response
Protocol Handshaking	# <b>CR</b>	~OK <b>CRLF</b>

Device initiated messages	
Command	Syntax
Start message	Kramer Electronics LTD. , <b>Device Model</b> Version <b>Software Version</b>

Switcher actions	
Audio-video channel has switched (AFV mode)	AV <b>IN&gt;OUT</b>
Video channel has switched (Breakaway mode)	VID <b>IN&gt;OUT</b>
Audio channel has switched (Breakaway mode)	AUD <b>IN&gt;OUT</b>



Result codes (errors)	
	<b>Syntax</b>
<b>No error. Command running succeeded</b>	COMMAND PARAMETERS OK
<b>Protocol Errors</b>	
<b>Syntax Error</b>	ERR001
<b>Command not available for this device</b>	ERR002
<b>Parameter is out of range</b>	ERR003
<b>Unauthorized access (running command without the match login).</b>	ERR004

Basic routing commands		
Command	Syntax	Response
Switch audio & video	AV <u>IN&gt;OUT</u> , <u>IN&gt;OUT</u> , ...	AV <u>IN&gt;OUT</u> , <u>IN&gt;OUT</u> ... <u>RESULT</u>
Switch video only	VID <u>IN&gt;OUT</u> , <u>IN&gt;OUT</u> , ... Short form: V <u>IN&gt;OUT</u> , <u>IN&gt;OUT</u> , ...	VID <u>IN&gt;OUT</u> , <u>IN&gt;OUT</u> , ... <u>RESULT</u>

Note:

When AFV mode is active, this command will switch also audio. If audio is breakaway – device display mode will change to show audio connections status.

Switch audio only	AUD <u>IN&gt;OUT</u> , <u>IN&gt;OUT</u> , ... Short form: A <u>IN&gt;OUT</u> , <u>IN&gt;OUT</u> , ...	AUD <u>IN&gt;OUT</u> , <u>IN&gt;OUT</u> , ... <u>RESULT</u>
-------------------	--	---

Note: When AFV mode is active, this command will switch also video.

Read video connection	VID? <u>OUT</u> Short form: V? <u>OUT</u> VID? *	VID <u>IN&gt;OUT</u>  VID <u>IN&gt;1</u> , <u>IN&gt;2</u> , ...
-----------------------	--	---

Read audio connection	AUD? <u>OUT</u> Short form: A? <u>OUT</u> AUD? *	AUD <u>IN&gt;OUT</u>  AUD <u>IN&gt;1</u> , <u>IN&gt;2</u> , ...
-----------------------	--	---

Parameters Description:

IN = Input number or '0' to disconnect output.

'>' = Connection character between in and out parameters.

OUT = Output number or '\*' for all outputs.

Examples:

Switch Video and Audio input 3 to output 7	#AV 3>7 <u>CR</u>	-AV 3>7 OK <u>CRLF</u>
Switch Video input 2 to output 4	#V 2>4 <u>CR</u>	-VID 2>4 OK <u>CRLF</u>
Switch Video input 4 to output 2 in machine number 6	#6@VID 4>2 <u>CR</u>	-6@VID 4>2 OK <u>CRLF</u>
Disconnect Video and Audio Output 4	#AV 0>4 <u>CR</u>	-AV 0>4 OK <u>CRLF</u>
Switch Video Input 3 to All Outputs	#V 3>* <u>CR</u>	-VID 3>* OK <u>CRLF</u>

## Kramer Protocol

Chaining Multiple commands*	#AV 1>*   V 3>4, 2>2, 82>1, 0>2  V 82>3  A 0>1   V? * <b>CR</b> First switch all Audio and video outputs from input 1, <b>Then switch video input 3 to output 4, video input 2 to output 2, video input and disconnect video output 2.</b> Then switch audio input 3 to output 2, Then disconnect audio output 1. Then get status of all links (assume this is 4x4 matrix). Commands processing start after entering <b>CR</b> , response will sent for each command after processing it.	~AV 1>* OK <b>CRLF</b> ~VID 1>2, 3>4 OK <b>CRLF</b> ~VID 82>3 <b>ERR###</b> <b>CRLF</b> ~AUD 0>1 OK <b>CRLF</b> ~V 1>1, 0>2, 1>3, 3>4 <b>CRLF</b>
-----------------------------	---	--

Signal Status commands		
Command	Syntax	Response
Change signal status	-----	SIGNAL <b>[INPUT]</b> , <b>[STATUS]</b>
Get signal status	SIGNAL? <b>[INPUT]</b>	SIGNAL <b>[INPUT]</b> , <b>[STATUS]</b>

Parameters Description:
<b>[NPUT]</b> = Input number, "*" for all.
<b>[STATUS]</b> = Signal state:
"0" or "off" for not existent signal.
"1" or "on" for existent signal.

Preset commands		
Command	Syntax	Response
Store current connections to preset	PRST-STO <b>[PRESET]</b> Short form: PSTO <b>[PRESET]</b>	PRST-STO <b>[PRESET]</b> <b>[RESULT]</b>
Recall saved preset	PRST-RCL <b>[PRESET]</b> Short form: PRCL <b>[PRESET]</b>	PRST-RCL <b>[PRESET]</b> <b>[RESULT]</b>
Delete saved preset	PRST-DEL <b>[PRESET]</b> Short form: PDEL <b>[PRESET]</b>	PRST-DEL <b>[PRESET]</b> <b>[RESULT]</b>
Read video connections from saved preset	PRST-VID? <b>[PRESET]</b> <b>[OUT]</b> Short form: PVID? <b>[PRESET]</b> <b>[OUT]</b> PRST-VID? <b>[PRESET]</b> , *	PRST-VID <b>[PRESET]</b> , <b>[IN]</b> <b>[OUT]</b>  PRST-VID <b>[PRESET]</b> , <b>[IN]</b> >1, <b>[IN]</b> >2,...
Read audio connections from saved preset	PRST-AUD? <b>[PRESET]</b> <b>[OUT]</b> Short form: PAUD? <b>[PRESET]</b> <b>[OUT]</b> PRST-AUD? <b>[PRESET]</b> , *	PRST-AUD <b>[PRESET]</b> : <b>[IN]</b> <b>[OUT]</b>  PRST-AUD <b>[PRESET]</b> : <b>[IN]</b> >1, <b>[IN]</b> >2,...
Read saved presets list	PRST-LST? Short form: PLST?	PRST-LST <b>[PRESET]</b> , <b>[PRESET]</b> , ...
<b>Parameters Description:</b> <b>[PRESET]</b> = Preset number. <b>[OUT]</b> = Output in preset to show for, "*" for all.		

Examples:		
Store current Audio & Video connections to preset 5	#PRST-STR 5 <b>CR</b>	~PRST-STR 5 OK <b>CRLF</b>

## Kramer Protocol

Examples:		
Recall Audio & Video connections from preset 3	#PRCL 3 <b>CR</b>	~PRST-RCL 3 OK <b>CRLF</b>
Show source of video output 2 from preset 3	#PRST-VID? 3,2 <b>CR</b>	~PRST-VID 3: 4>2 <b>CRLF</b>

Operation commands		
Command	Syntax	Response
Lock front panel	<b>LOCK-FP</b> <b>LOCK-MODE</b> Short form: <b>LCK</b> <b>LOCK-MODE</b>	<b>LOCK-FP</b> <b>LOCK-MODE</b> <b>RESULT</b>

Get front panel locking state	<b>LOCK-FP?</b>	<b>LOCK-FP</b> <b>LOCK-MODE</b>
<b>Parameters Description:</b>		
<b>LOCK-MODE</b> = Front panel locking state: "0" or "off" to unlock front panel buttons. "1" or "on" to lock front panel buttons.		
Restart device	<b>RESET</b>	<b>RESET OK</b>

Switch to protocol 2000*	<b>P2000</b>	<b>P2000 OK</b>
* Protocol 2000 has command to switch back to ASCII protocol (like protocol 3000)		

Audio parameters commands		
Command	Syntax	Response
Set audio level in specific amplifier stage.	<b>AUD-LVL</b> <b>STAGE</b> <b>CHANNEL</b> <b>VOLUME</b> Short form: <b>ADL</b> <b>STAGE</b> <b>CHANNEL</b> <b>VOLUME</b>	<b>AUD-LVL</b> <b>STAGE</b> <b>CHANNEL</b> <b>VOLUME</b> <b>RESULT</b>
Read audio volume level	<b>AUD-LVL?</b> <b>STAGE</b> <b>CHANNEL</b> Short form: <b>ADL?</b> <b>STAGE</b>	<b>AUD-LVL</b> <b>STAGE</b> <b>CHANNEL</b> <b>VOLUME</b>

Mute audio	<b>MUTE</b> <b>MUTE-MODE</b>	<b>MUTE</b> <b>MUTE-MODE</b> <b>RESULT</b>
------------	------------------------------	--

**Parameters Description:**

**STAGE** =

"In", "Out"

or

Numeric value (present audio processing stage). For example: "0" for Input level, "1" for Pre-Amplifier, "2" for Amplifier (Out) etc.

**CHANNEL** = Input or Output #

**VOLUME** = Audio parameter in Kramer units, precede minus sign for negative values.

++ increase current value

-- decrease current value

**MUTE MODE** = 1 – Mute

0 – Unmute

Machine info commands		
Command	Syntax	Response
* Time settings commands require admin authorization		



## Kramer Protocol

Machine info commands		
Read in/outs count	INFO-IO?	INFO-IO: IN <code>[INPUTS_COUNT]</code> , OUT <code>[OUTPUTS_COUNT]</code>

Read max presets count	INFO-PRST?	INFO-PRST: VID <code>[PRESET_VIDEO_COUNT]</code> , AUD <code>[PRESET_AUDIO_COUNT]</code>
------------------------	------------	--

Reset configuration to factory default	FACTORY	FACTORY <code>[RESULT]</code>
--	---------	-------------------------------

Identification commands		
Command	Syntax	Response

Protocol Handshaking	# <code>[CR]</code>	~OK <code>[CRLF]</code>
----------------------	---------------------	-------------------------

Read device model	MODEL?	MODEL <code>[MACHINE_MODEL]</code>
-------------------	--------	------------------------------------

Read device serial number	SN?	SN <code>[SERIAL_NUMBER]</code>
---------------------------	-----	---------------------------------

Read device firmware version	VERSION?	VERSION <code>[MAJOR]</code> <code>[MINOR]</code> <code>[BUILD]</code> <code>[REVISION]</code>
------------------------------	----------	--

Set machine name	NAME <code>[MACHINE_NAME]</code>	NAME <code>[MACHINE_NAME]</code> <code>[RESULT]</code>
------------------	----------------------------------	--

Read machine name	NAME?	NAME <code>[MACHINE_NAME]</code>
-------------------	-------	----------------------------------

Reset machine name to factory default*	NAME-RST	NAME-RST <code>[MACHINE_FACTORY_NAME]</code> <code>[RESULT]</code>
--	----------	--

\*Note: machine name not equal to model name. This name relevance for site viewer identification of specific machine or for network using (with DNS feature on).

`[MACHINE_NAME]` = Up to 14 Alfa-Numeric chars.

\* **Machine factory name** = Model name + last 4 digits from serial number.

Set machine id number	MACH-NUM <code>[MACHINE_NUMBER]</code>	MACH-NUM <code>[OLD_MACHINE_NUMBER]</code> <code>[NEW_MACHINE_NUMBER]</code> <code>[RESULT]</code>
-----------------------	--	--

\* Response will send after machine number has been changed. So the replay with header will be:

`[NEW_MACHINE_NUMBER]` @MACH-NUM `[OLD_MACHINE_NUMBER]` `[NEW_MACHINE_NUMBER]` OK

Network settings commands		
---------------------------	--	--

Set IP Address	NET-IP <code>[IP_ADDRESS]</code> NTIP	NET-IP <code>[IP_ADDRESS]</code> <code>[RESULT]</code>
----------------	--	--

Read IP Address	NET-IP? NTIP?	NET-IP <code>[IP_ADDRESS]</code>
-----------------	------------------	----------------------------------

Read MAC Address	NET-MAC? NTMC	NET-MAC <code>[MAC_ADDRESS]</code>
------------------	------------------	------------------------------------

Set subnet mask	NET-MASK <code>[SUBNET_MASK]</code> NTMSK	NET-MASK <code>[SUBNET_MASK]</code> <code>[RESULT]</code>
-----------------	--	---

Read subnet mask	NET-MASK? NTMSK?	NET-MASK <code>[SUBNET_MASK]</code>
------------------	---------------------	-------------------------------------

Set gateway address	NET-GATE <code>[GATEWAY_ADDRESS]</code>	NET-GATE <code>[GATEWAY_ADDRESS]</code> <code>[RESULT]</code>
---------------------	---	---

## Kramer Protocol

Network settings commands		
	<b>NTGT</b>	
Read subnet mask	NET-GATE? NTGT?	NET-GATE <u>GATEWAY_ADDRESS</u>

Set DHCP mode	NET-DHCP <u>DHCP_MODE</u> NTDH	NET-DHCP <u>DHCP_MODE</u> <u>RESULT</u>
Read subnet mask	NET-DHCP? NTDH?	NET-DHCP <u>DHCP_MODE</u>

**DHCP\_MODE** =

0 – Don't use DHCP (Use IP set by factory or IP set command).

1 – Try to use DHCP, if unavailable use IP as above.

Change protocol Ethernet port	ETH-PORT <u>PROTOCOL</u> , <u>PORT</u> ETHP	ETH-PORT <u>PROTOCOL</u> , <u>PORT</u> <u>RESULT</u>
Read protocol Ethernet port	ETH-PORT? <u>PROTOCOL</u> ETHP?	ETH-PORT <u>PROTOCOL</u> , <u>PORT</u>

PROTOCOL = TCP / UDP (transport layer protocol)

PORT = Ethernet port to enter protocol 3000 commands

1-65535 = User defined port

0 - reset port to factory default (50000 for UDP, 5000 for TCP)

Advanced switching commands		
Command	Syntax	Response
Set audio follow video mode	AFV <u>AFV-MODE</u>	AFV <u>AFV-MODE</u> <u>RESULT</u>
Note: This command effect device front-panel mode and AUD\VID command		
Read audio follow video mode	AFV?	AFV <u>AFV-MODE</u>

**AFV-MODE** = Front panel AFV mode

"0" or "afv" to set front panel switching buttons in audio-follow-video state

"1" or "brk" to set front panel switching buttons in their previous state when audio

### 17.3 Kramer Protocol 2000

This RS-232/RS-485 communication protocol (Version 0.5) uses four bytes of information as defined below. For RS-232, a null-modem connection between the machine and controller is used. The default data rate is 9600 baud, with no parity, 8 data bits and 1 stop bit.

Table 17: Protocol Definitions

MSB		INSTRUCTION						LSB
		DESTINATION						
0	D	N5	N4	N3	N2	N1	N0	
7	6	5	4	3	2	1	0	

1st byte

INPUT							
1	I6	I5	I4	I3	I2	I1	0
7	6	5	4	3	2	1	0

2nd byte

OUTPUT							
1	O6	O5	O4	O3	O2	O1	O0
7	6	5	4	3	2	1	0

3rd byte

MACHINE NUMBER							
1	OVR	X	M4	M3	M2	M1	M0
7	6	5	4	3	2	1	0

4th byte

1<sup>st</sup> BYTE: Bit 7 – Defined as 0

D – “DESTINATION”: 0 - for sending information to the switchers (from the PC);

1 - for sending to the PC (from the switcher)

N5 N0 – “INSTRUCTION”

The function that is to be performed by the switcher(s) is defined by the INSTRUCTION (6 bits). Similarly, if a function is performed via the machine’s keyboard, then these bits are set with the INSTRUCTION NO., which was performed. The instruction codes are defined according to the table below (INSTRUCTION NO. is the value to be set for N5 – N0).

2<sup>nd</sup> BYTE: Bit 7 – Defined as 1

I6 I0 – “INPUT”

When switching (ie instruction codes 1 and 2), the INPUT (7 bits) is set as the input number which is to be switched. Similarly, if switching is done via the machine’s front-panel, then these bits are set with the INPUT NUMBER which was switched. For other operations, these bits are defined according to the table

3<sup>rd</sup> BYTE: Bit 7 – Defined as 1

O6 O0 – “OUTPUT”

When switching (ie instruction codes 1 and 2), the OUTPUT (7 bits) is set as the output number which is to be switched. Similarly, if switching is done via the machine’s front-panel, then these bits are set with the OUTPUT NUMBER which was switched. For other operations, these bits are defined according to the table

4<sup>th</sup> BYTE: Bit 7 – Defined as 1

Bit 5 – Don’t care

OVR – Machine number override

M4 M0 – MACHINE NUMBER

## Kramer Protocol

Used to address machines in a system via their machine numbers. When several machines are controlled from a single serial port, they are usually configured together with each machine having an individual machine number. If the OVR bit is set, then all machine numbers will accept (implement) the command, and the addressed machine will reply.

For a single machine controlled via the serial port, always set M4 M0 = 1, and make sure that the machine itself is configured as MACHINE NUMBER = 1

*Table 18: Instruction Codes for Protocol 2000*

Note: All values in the table are decimal, unless otherwise stated

INSTRUCTION		DEFINITION FOR SPECIFIC INSTRUCTION		NOTE
#	DESCRIPTION	INPUT	OUTPUT	
0	RESET VIDEO	0	0	1
1	SWITCH VIDEO	Set equal to video input which is to be switched (0 = disconnect)	Set equal to video output which is to be switched (0 = to all the outputs)	2
2	SWITCH AUDIO	Set equal to audio input which is to be switched (0 = disconnect)	Set equal to audio output which is to be switched (0 = to all the outputs)	2
3	STORE VIDEO STATUS	Set as SETUP #	0 - to store 1 - to delete	2, 3
4	RECALL VIDEO STATUS	Set as SETUP #	0	2, 3
5	REQUEST STATUS OF A VIDEO OUTPUT	Set as SETUP #	Equal to output number whose status is required	4, 3
6	REQUEST STATUS OF AN AUDIO OUTPUT	Set as SETUP #	Equal to output number whose status is required	4, 3
8	BREAKAWAY SETTING	0	0 - audio-follow-video 1 - audio breakaway	2
11	REQUEST BREAKAWAY SETTING	Set as SETUP #	0 - Request audio breakaway setting	3, 4, 6
15	REQUEST WHETHER SETUP IS DEFINED / VALID INPUT IS DETECTED	SETUP # or Input #	0 - for checking if setup is defined 1 - for checking if input is valid	8
16	ERROR / BUSY	For invalid / valid input (i.e. OUTPUT byte = 4 or OUTPUT byte = 5), this byte is set as the input #	0 - error 1 - invalid instruction 2 - out of range 3 - machine busy 4 - invalid input 5 - valid input 6 - RX buffer overflow	9, 25
22	SET AUDIO PARAMETER	Equal to input / output number whose parameter is to be set (0 = all)	Set as parameter value	2, 24
24	INCREASE / DECREASE AUDIO PARAMETER	Equal to input / output number whose parameter is to be increased / decreased (0 = all)	0 - increase output 1 - decrease output	2
25	REQUEST AUDIO PARAMETER	Equal to input / output number whose parameter is requested	0	6, 24
30	LOCK FRONT PANEL	0 - Panel unlocked 1 - Panel locked	0	2
31	REQUEST WHETHER PANEL IS LOCKED	0	0	16

## Kramer Protocol

INSTRUCTION		DEFINITION FOR SPECIFIC INSTRUCTION		NOTE
#	DESCRIPTION	INPUT	OUTPUT	
42	AUDIO PARAMETER SETTING FOR INSTRUCTIONS 22, 24, 25	INPUT Bit: 0 - 0=input; 1=output I1 - Left I2 - Right	0 - Gain 1 - Bass 2 - Treble 3 - Midrange 4 - Mix On	24
56	CHANGE TO ASCII	0	Kramer protocol 3000	19
61	IDENTIFY MACHINE	1 - video machine name 2 - audio machine name 3 - video software version 4 - audio software version	0 - Request first 4 digits 1 - Request first suffix 2 - Request second suffix 3 - Request third suffix 10 - Request first prefix 11 - Request second prefix 12 - Request third prefix	13
62	DEFINE MACHINE	1 - number of inputs 2 - number of outputs 3 - number of setups	1 - for video 2 - for audio	14

NOTES on the above table:

NOTE 1 - When the master switcher is reset, (e.g. when it is turned on), the reset code is sent to the PC. If this code is sent to the switchers, it will reset according to the present power-down settings.

NOTE 2 - These are bi-directional definitions. That is, if the switcher receives the code, it will perform the instruction; and if the instruction is performed (due to a keystroke operation on the front panel), then these codes are sent. For example, if the HEX code

01            85            88            83

was sent from the PC, then the switcher (machine 3) will switch input 5 to output 8. If the user switched input 1 to output 7 via the front panel keypad, then the switcher will send HEX codes:

41            81            87            83

to the PC.

When the PC sends one of the commands in this group to the switcher, then, if the instruction is valid, the switcher replies by sending to the PC the same four bytes that it was sent (except for the first byte, where the DESTINATION bit is set high).

NOTE 3 - SETUP # 0 is the present setting. SETUP # 1 and higher are the settings saved in the switcher's memory, (i.e. those used for Store and Recall).

NOTE 4 - The reply to a "REQUEST" instruction is as follows: the same instruction and INPUT codes as were sent are returned, and the OUTPUT is assigned the value of the requested parameter. The replies to instructions 10 and 11 are as per the definitions in instructions 7 and 8 respectively. For example, if the present status of machine number 5 is breakaway setting, then the reply to the HEX code

0B            80            80            85

would be HEX codes

4B            80            81            85

NOTE 6 - If INPUT is set to 127 for these instructions, then, if the function is defined on this machine, it replies with OUTPUT=1. If the function is not defined, then the machine replies with OUTPUT=0, or with an error (invalid instruction code).

If the INPUT is set to 126 for these instructions, then, if possible, the machine will return the current setting of this function, even for the case that the function is not defined. For example, for a video switcher which always switches during the VIS of input #1, (and its VIS setting cannot be programmed otherwise), the reply to the HEX code

0A            FE            80            81 (i.e. request VIS setting, with INPUT set as 126dec)

would be HEX codes



## Kramer Protocol

4A FE 81 81 (ie VIS setting = 1, which is defined as VIS from input #1)

NOTE 8 - The reply is as in TYPE 3 above, except that here the OUTPUT is assigned with the value 0 if the setup is not defined / no valid input is detected; or 1 if it is defined / valid input is detected

NOTE 9 - An error code is returned to the PC if an invalid instruction code was sent to the switcher, or if a parameter associated with the instruction is out of range (e.g. trying to save to a setup greater than the highest one, or trying to switch an input or output greater than the highest one defined) This code is also returned to the PC if an RS-232 instruction is sent while the machine is being programmed via the front panel. Reception of this code by the switcher is not valid

NOTE 10 – This code is reserved for internal use

NOTE 13 - This is a request to identify the switcher/s in the system. If the OUTPUT is set as 0, and the INPUT is set as 1, 2, 5 or 7, the machine will send its name. The reply is the decimal value of the INPUT and OUTPUT. For example, for a 2216, the reply to the request to send the audio machine name would be (HEX codes):

7D 96 90 81 (i.e. 128dec+22dec for 2nd byte, and 128dec+16dec for 3rd byte)

If the request for identification is sent with the INPUT set as 3 or 4, the appropriate machine will send its software version number. Again, the reply would be the decimal value of the INPUT and OUTPUT - the INPUT representing the number in front of the decimal point, and the OUTPUT representing the number after it. For example, for version 3.5, the reply to the request to send the version number would be (HEX codes):

7D 83 85 81 (i.e. 128dec+3dec for 2nd byte, 128dec+5dec for 3rd byte)

If the OUTPUT is set as 1, then the ASCII coding of the lettering following the machine's name is sent. For example, for the VS-7588YC, the reply to the request to send the first suffix would be (HEX codes):

7D D9 C3 81 (i.e. 128dec+ASCII for "Y"; 128dec+ASCII for "C")

NOTE 14 - The number of inputs and outputs refers to the specific machine which is being addressed, not to the system. For example, if six 16X16 matrices are configured to make a 48X32 system (48 inputs, 32 outputs), the reply to the HEX code

3E 82 81 82 (ie request the number of outputs)

would be HEX codes

7E 82 90 82

ie 16 outputs

NOTE 16 - The reply to the "REQUEST WHETHER PANEL IS LOCKED" is as in NOTE 4 above, except that here the OUTPUT is assigned with the value 0 if the panel is unlocked, or 1 if it is locked

NOTE 19 – After this instruction is sent, the unit will respond to the ASCII command set defined by the OUTPUT byte. The ASCII command to operate with the HEX command set must be sent in order to return to working with HEX codes

NOTE 24 – Further information needed in instructions 21, 22, 25 and 26 is sent using instruction 42 – which is sent prior to the instruction. For example, to request the audio gain value of right input # 9, send hex codes

2A 84 80 81

and then send HEX codes

19 89 81 81

To set MIX mode, send hex codes

2A 81 84 81

and then send HEX codes

16

NOTE 25 – For units which detect the validity of the video inputs, Instruction 16 will be sent whenever the unit detects a change in the state of an input (in real-time)

For example, if input 3 is detected as invalid, the unit will send the HEX codes

10 83 84 81

## Kramer Protocol

---

If input 7 is detected as valid, then the unit will send HEX codes

10            87            85            81

## LIMITED WARRANTY

Kramer Electronics (hereafter *Kramer*) warrants this product free from defects in material and workmanship under the following terms

### HOW LONG IS THE WARRANTY

Labor and parts are warranted for seven years from the date of the first customer purchase

### WHO IS PROTECTED?

Only the first purchase customer may enforce this warranty

### WHAT IS COVERED AND WHAT IS NOT COVERED

Except as below, this warranty covers all defects in material or workmanship in this product. The following are not covered by the warranty:

- 1 Any product which is not distributed by Kramer, or which is not purchased from an authorized Kramer dealer. If you are uncertain as to whether a dealer is authorized, please contact Kramer at one of the agents listed in the Web site [www.kramerelectronics.com](http://www.kramerelectronics.com)
- 2 Any product, on which the serial number has been defaced, modified or removed, or on which the WARRANTY VOID IF TAMPERED sticker has been torn, reattached, removed or otherwise interfered with
- 3 Damage, deterioration or malfunction resulting from:
  - i) Accident, misuse, abuse, neglect, fire, water, lightning or other acts of nature
  - ii) Product modification, or failure to follow instructions supplied with the product
  - iii) Repair or attempted repair by anyone not authorized by Kramer
  - iv) Any shipment of the product (claims must be presented to the carrier)
  - v) Removal or installation of the product
  - vi) Any other cause, which does not relate to a product defect
  - vii) Cartons, equipment enclosures, cables or accessories used in conjunction with the product

### WHAT WE WILL PAY FOR AND WHAT WE WILL NOT PAY FOR

We will pay labor and material expenses for covered items. We will not pay for the following:

- 1 Removal or installations charges
- 2 Costs of initial technical adjustments (set-up), including adjustment of user controls or programming. These costs are the responsibility of the Kramer dealer from whom the product was purchased
- 3 Shipping charges

### HOW YOU CAN GET WARRANTY SERVICE

- 1 To obtain service on your product, you must take or ship it prepaid to any authorized Kramer service center
- 2 Whenever warranty service is required, the original dated invoice (or a copy) must be presented as proof of warranty coverage, and should be included in any shipment of the product. Please also include in any mailing a contact name, company, address, and a description of the problem(s)
- 3 For the name of the nearest Kramer authorized service center, consult your authorized dealer

### LIMITATION OF IMPLIED WARRANTIES

All implied warranties, including warranties of merchantability and fitness for a particular purpose, are limited in duration to the length of this warranty

### EXCLUSION OF DAMAGES

The liability of Kramer for any effective products is limited to the repair or replacement of the product at our option. Kramer shall not be liable for:

- 1 Damage to other property caused by defects in this product, damages based upon inconvenience, loss of use of the product, loss of time, commercial loss; or
- 2 Any other damages, whether incidental, consequential or otherwise. Some countries may not allow limitations on how long an implied warranty lasts and/or do not allow the exclusion or limitation of incidental or consequential damages, so the above limitations and exclusions may not apply to you

This warranty gives you specific legal rights, and you may also have other rights, which vary from place to place

**NOTE:** All products returned to Kramer for service must have prior approval. This may be obtained from your dealer

This equipment has been tested to determine compliance with the requirements of:

- EN-50081: "Electromagnetic compatibility (EMC);  
generic emission standard  
Part 1: Residential, commercial and light industry"
- EN-50082: "Electromagnetic compatibility (EMC) generic immunity standard  
Part 1: Residential, commercial and light industry environment"
- CFR-47: FCC\* Rules and Regulations:  
Part 15: "Radio frequency devices  
Subpart B Unintentional radiators"

### CAUTION!

- ⊠ Servicing the machines can only be done by an authorized Kramer technician. Any user who makes changes or modifications to the unit without the expressed approval of the manufacturer will void user authority to operate the equipment
- ⊠ Use the supplied DC power supply to feed power to the machine
- ⊠ Please use recommended interconnection cables to connect the machine to other components  
\* FCC and CE approved using STP cable (for twisted pair products)



---

**For the latest information on our products and a list of Kramer distributors, visit [www.kramerelectronics.com](http://www.kramerelectronics.com) where updates to this user manual may be found. We welcome your questions, comments and feedback.**



**Caution**

**Safety Warning:**

Disconnect the unit from the power supply before opening/servicing.



---

**Kramer Electronics, Ltd.**

Web site: [www.kramerelectronics.com](http://www.kramerelectronics.com)

E-mail: [info@kramereel.com](mailto:info@kramereel.com)

**P/N: 2900-000657 REV 3**