

Kramer Electronics, Ltd.

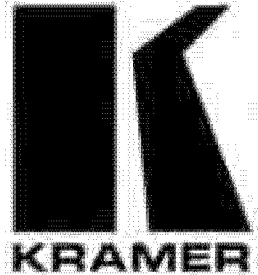

USER MANUAL

Models:

VP-81xl, 8x1 XGA / Audio Switcher

VP-161xl, 16x1 XGA / Audio Switcher

VP-321xl, 32x1 XGA / Audio Switcher

Contents

1	Introduction	1
2	Getting Started	1
3	Overview	2
4	Your XGA / Audio Switcher	2
4.1	VP-81xl 8x1 XGA / Audio Switcher	2
4.2	VP-161xl 16x1 XGA / Audio Switcher	4
4.3	VP-321xl 32x1 XGA / Audio Switcher	6
5	Connecting an XGA / Audio Switcher	8
5.1	Connecting the Balanced/Unbalanced Stereo Audio Input/Output	8
5.2	Controlling via RS-232	9
5.3	Controlling via RS-485	10
5.4	Dipswitch Settings	11
5.4.1	Setting the MACHINE #	11
5.4.2	Setting the MACHINE ADDRESS #	13
5.4.3	Example: Connecting a Set of Three Cascaded VP-81xl Units	15
5.5	Connecting the REMOTE Terminal Block Connector	16
6	Operating Your XGA / Audio Switcher	18
6.1	Using the Front Panel INPUT SELECTOR Buttons	18
6.1.1	Using the INPUT SELECTOR Buttons on a Single Unit	18
6.1.2	Using the INPUT SELECTOR Buttons on a Set of Units	18
6.1.3	Using the Audio-Follow-Video (AFV) / Breakaway Modes	20
6.1.3.1	Operating in Breakaway Mode	20
6.1.3.2	Toggling between Video and Audio Control in Breakaway Mode	20
6.1.3.3	Operating in the Audio-Follow-Video Mode	20
7	Flash Memory Upgrade	21
7.1	Downloading from the Internet	21
7.2	Connecting the PC to the RS-232 Port	21
7.3	Upgrading Firmware	22
8	Technical Specifications	27
9	Table of Hex Codes for Serial Communication	28

Figures

Figure 1: VP-81xl 8x1 XGA / Audio Switcher	3
Figure 2: VP-161xl 16x1 XGA / Audio Switcher	4
Figure 3: VP-321xl 32x1 XGA / Audio Switcher	6
Figure 4: Connecting the Balanced Stereo Audio Input/Output	8
Figure 5: Connecting the Unbalanced Stereo Audio Input/Output	8
Figure 6: Connecting a PC without using a Null-modem Adapter	9
Figure 7: Controlling via RS-485	10
Figure 8: SETUP Dipswitches (Factory Default for Stand-Alone MACHINE # 1)	11
Figure 9: Dipswitch Settings on 4 VP-81xl, VP-161xl, and/or VP-321xl Units	12
Figure 10: An Interconnected Set of Three Looped VP-81xl Units (Video Connections Shown)	16
Figure 11: Connecting a Remote Mechanical Switcher Unit to the VP-81xl	16
Figure 12: Connecting a Remote Unit to a Cascaded Set of Three VP-81xl Units	17
Figure 13: Operating a 22x1 XGA / Audio Switcher (Three Looped VP-81xl Units)	19
Figure 14: Splash Screen	22
Figure 15: Atmel – Flip Window	23
Figure 16: Open Configuration File Select Window	23
Figure 17: Atmel – Flip Window (RS-232 Communication)	24
Figure 18: RS-232 Window	24
Figure 19: Atmel – Flip Window (Connected)	25
Figure 20: Atmel – Flip Window (Operation Completed)	26

Tables

Table 1: Front Panel VP-81xl 8x1 XGA / Audio Switcher Features	3
Table 2: Rear Panel VP-81xl 8x1 XGA / Audio Switcher Features	3
Table 3: Front Panel VP-161xl 16x1 XGA / Audio Switcher Features	5
Table 4: Rear Panel VP-161xl 16x1 XGA / Audio Switcher Features	5
Table 5: Front Panel VP-321xl 32x1 XGA / Audio Switcher Features	7
Table 6: Rear Panel VP-321xl 32x1 XGA / Audio Switcher Features	7
Table 7: Dipswitch Definitions	11
Table 8: MACHINE # Dipswitch Settings	11
Table 9: MACHINE ADDRESS # Dipswitch Settings	14
Table 10: Technical Specifications of the VP-81xl/VP-161xl/VP-321xl	27
Table 11: VP-81xl/VP-161xl/VP-321xl Hex Codes	28

1 Introduction

Welcome to Kramer Electronics (since 1981): a world of unique, creative and affordable solutions to the infinite range of problems that confront the video, audio and presentation professional on a daily basis. In recent years, we have redesigned and upgraded most of our line, making the best even better! Our 350-plus different models now appear in 8 Groups¹, which are clearly defined by function.

Congratulations on purchasing your Kramer XGA and balanced stereo audio switcher, which is available in the following models: **VP-81xl**, **VP-161xl**, and **VP-321xl**. The **VP-81xl** is an 8x1 *XGA / Audio Switcher*, the **VP-161xl** is a 16x1 *XGA / Audio Switcher*, and the **VP-321xl** is a 32x1 *XGA / Audio Switcher*.

The **VP-81xl**, **VP-161xl**, and **VP-321xl** are ideal for these typical applications:

- Display systems requiring simple input selection (from 8 inputs to up to 218 inputs)
- Remote monitoring of computer activity in schools and businesses
- Rental/staging applications
- Multimedia and presentation source selection

The package includes the following items:

- XGA / Audio Switcher (**VP-81xl**, **VP-161xl** or **VP-321xl**)
- Null-modem adapter, a power cord and an Infra-red remote control transmitter (including the required battery and a separate user manual²)
- This user manual²

2 Getting Started

We recommend that you:

- Unpack the equipment carefully and save the original box and packaging materials for possible future shipment
- Review the contents of this user manual
- Use Kramer high performance high resolution cables³

1 GROUP 1: Distribution Amplifiers; GROUP 2: Video and Audio Switchers, Matrix Switchers and Controllers; GROUP 3: Video, Audio, VGA/XGA Processors; GROUP 4: Interfaces and Sync Processors; GROUP 5: Twisted Pair Interfaces; GROUP 6: Accessories and Rack Adapters; GROUP 7: Scan Converters and Sealers; and GROUP 8: Cables and Connectors

2 Download up-to-date Kramer user manuals from the Internet at this URL: <http://www.kramerelectronics.com>

3 The complete list of Kramer cables is on our Web site at <http://www.kramerelectronics.com>

3 Overview

The **VP-81xl**, **VP-161xl**, and **VP-321xl** route any input to the output, using 15-pin HD female connectors for the VGA/XGA signals, and detachable terminal block connectors for the balanced stereo audio.

In particular, the **VP-81xl**, **VP-161xl**, and **VP-321xl** include:

- Very high video bandwidth, ensuring transparent VGA/XGA performance
- Audio-follow-video (AFV) in which all operations relate to both the video and the audio channels, or audio breakaway option, in which video and audio channels switch independently
- An ability to cascade up to seven units to increase the number of inputs
- High standard directly coupled inputs and outputs
- Compatibility with the Kramer **VPM-2 XGA Line Driver** wall plate
- Control from the front panel, or via RS-232/RS-485 serial commands transmitted by a touch screen system, PC, or other serial control device, as well as via an infra-red remote controller, or via remote contact-closure switches

To achieve the best performance:

- Connect only good quality connection cables, thus avoiding interference, deterioration in signal quality due to poor matching, and elevated noise levels (often associated with low quality cables)
- Avoid interference from neighboring electrical appliances that may adversely influence signal quality and position your **VP-81xl/VP-161xl/VP-321xl** away from moisture, excessive sunlight and dust

4 Your XGA / Audio Switcher

This section includes a description of the:

- **VP-81xl**, 8x1 XGA / Audio Switcher (see section 4.1)
- **VP-161xl**, 16x1 XGA / Audio Switcher (see section 4.2)
- **VP-321xl**, 32x1 XGA / Audio Switcher (see section 4.3)

4.1 VP-81xl 8x1 XGA / Audio Switcher

The **VP-81xl** is an 8x1 switcher for VGA / XGA signals and balanced audio stereo signals that lets you route one of up to 8 inputs to one output.

Figure 1, Table 1 and Table 2 define the **VP-81xl 8x1 XGA / Audio Switcher**:

Your XGA / Audio Switcher

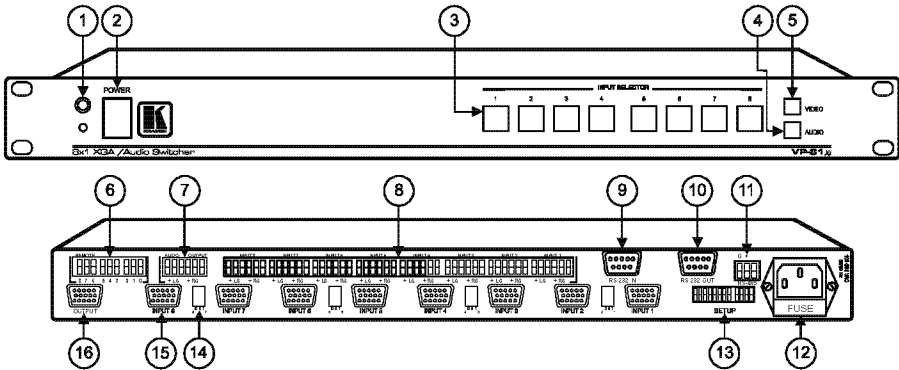

Figure 1: VP-81xl 8x1 XGA / Audio Switcher

Table 1: Front Panel VP-81xl 8x1 XGA / Audio Switcher Features

#	Feature	Function
1	IR Receiver	The red LED is illuminated when receiving signals from the Kramer Infra-red remote control transmitter
2	POWER Switch	Illuminated switch supplying power to the unit
3	INPUT SELECTOR Buttons	Select the input to switch to the output (from 1 to 8)
4	AUDIO Button	When illuminated ¹ actions relate to audio
5	VIDEO Button	When illuminated ¹ actions relate to video

Table 2: Rear Panel VP-81xl 8x1 XGA / Audio Switcher Features

#	Feature	Function
6	REMOTE Terminal Block Connectors	Connect to the remote contact-closure switches
7	AUDIO OUTPUT Terminal Block Connector	Connect to the balanced audio acceptor
8	AUDIO INPUTS Terminal Block Connectors	Connect to the balanced audio sources (from 1 to 8)
9	RS-232 IN DB 9F Port	Connects to the PC or RS-232 remote controller
10	RS-232 OUT DB 9M Port	Connects to the RS-232 IN DB 9F port of the next unit in the daisy-chain
11	RS-485 Detachable Terminal Block Port	Pin # 1 is for Ground connection, and Pins # 2 and # 3 are for RS-485
12	Power Connector with FUSE	AC connector enabling power supply to the unit
13	SETUP Dipswitches	Dipswitches for setup of the unit
14	ID BIT Switch	Selects the ID BIT when switched ON (when outputting the input signal from a notebook connected to an external VGA monitor) ²
15	INPUT HD15F Connectors	Connect to the VGA/XGA sources (from 1 to 8)
16	OUTPUT HD15F Connector	Connects to the VGA/XGA acceptor

1 If the AUDIO and VIDEO buttons both illuminate, the unit operates in the audio-follow-video mode. If only one button illuminates (AUDIO or VIDEO), the unit operates in the breakaway mode

2 Sometimes notebook computers refuse to output a VGA signal to an external VGA monitor if they do not detect the ID BIT as ON. Set the ID BIT to ON using this button so that the notebook will output to an external VGA monitor

4.2 VP-161xl 16x1 XGA / Audio Switcher

The **VP-161xl** is a 16x1 switcher for VGA / XGA signals and balanced audio stereo signals that lets you route one of up to 16 inputs to one output.

Figure 2, Table 3 and Table 4 define the **VP-161xl 16x1 XGA / Audio Switcher**:

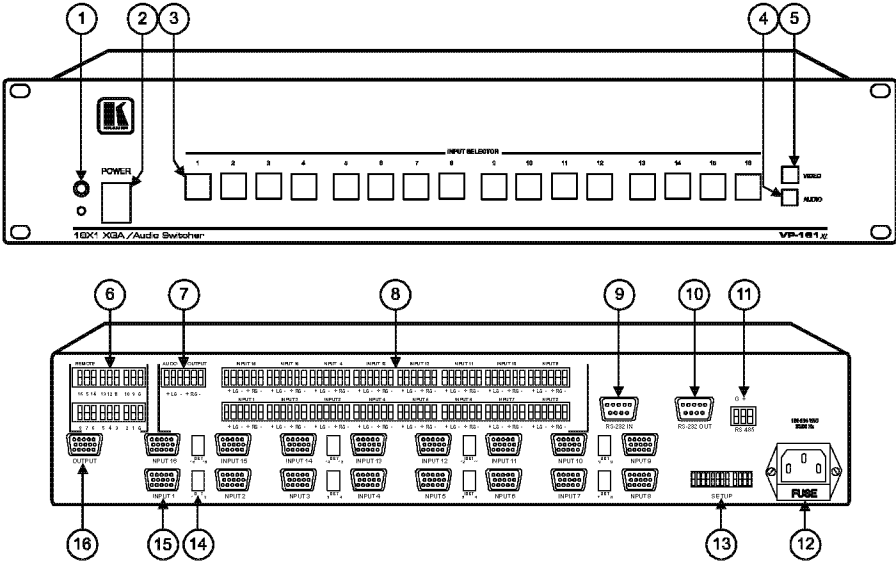

Figure 2: VP-161xl 16x1 XGA / Audio Switcher

Table 3: Front Panel VP-161xl 16x1 XGA / Audio Switcher Features

#	Feature	Function
1	IR Receiver	The red LED is illuminated when receiving signals from the Kramer Infra-red remote control transmitter
2	POWER Switch	Illuminated switch supplying power to the unit
3	INPUT SELECTOR Buttons	Select the input to switch to the output (from 1 to 16)
4	AUDIO Button	When illuminated ¹ actions relate to audio
5	VIDEO Button	When illuminated ¹ actions relate to video

Table 4: Rear Panel VP-161xl 16x1 XGA / Audio Switcher Features

#	Feature	Function
6	REMOTE Terminal Block Connectors	Connect to the remote contact-closure switches
7	AUDIO OUTPUT Terminal Block Connector	Connect to the balanced audio acceptor
8	AUDIO INPUTS Terminal Block Connectors	Connect to the balanced audio sources (from 1 to 16)
9	RS-232 IN DB 9F Port	Connects to the PC or RS-232 remote controller
10	RS-232 OUT DB 9M Port	Connects to the RS-232 IN DB 9F port of the next unit in the daisy-chain
11	RS-485 Detachable Terminal Block Port	Pin # 1 is for Ground connection, and Pins # 2 and # 3 are for RS-485
12	Power Connector with FUSE	AC connector enabling power supply to the unit
13	SETUP Dipswitches	Dipswitches for setup of the unit
14	INPUT HD15F Connectors	Connect to the VGA/XGA sources (from 1 to 16)
15	ID BIT Switch	Selects the ID BIT when switched ON (when outputting the input signal from a notebook connected to an external VGA monitor) ²
16	OUTPUT HD15F Connector	Connects to the VGA/XGA acceptor

1 If the AUDIO and VIDEO buttons both illuminate, the unit operates in the audio-follow-video mode. If only one button illuminates (AUDIO or VIDEO), the unit operates in the breakaway mode

2 Sometimes notebook computers refuse to output a VGA signal to an external VGA monitor if they do not detect the ID BIT as ON. Set the ID BIT to ON using this button so that the notebook will output to an external VGA monitor

4.3 VP-321xl 32x1 XGA / Audio Switcher

The VP-321xl is a 32x1 switcher for VGA / XGA signals and balanced audio stereo signals that lets you route one of up to 32 inputs to one output.

Figure 3, Table 5 and Table 6 define the VP-321xl 32x1 XGA / Audio Switcher:

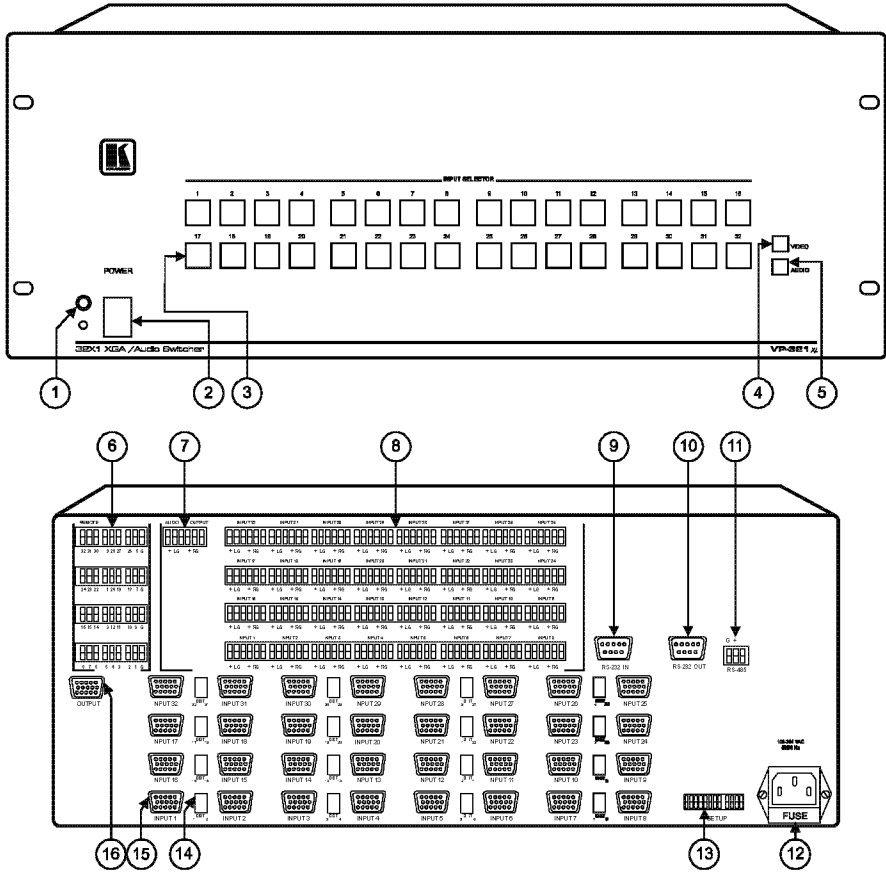

Figure 3: VP-321xl 32x1 XGA / Audio Switcher

Table 5: Front Panel VP-321xl 32x1 XGA / Audio Switcher Features

#	Feature	Function
1	IR Receiver	The red LED is illuminated when receiving signals from the Kramer Infra-red remote control transmitter
2	POWER Switch	Illuminated switch supplying power to the unit
3	INPUT SELECTOR Buttons	Select the input to switch to the output (from 1 to 32)
4	AUDIO Button	When illuminated ¹ actions relate to audio
5	VIDEO Button	When illuminated ¹ actions relate to video

Table 6: Rear Panel VP-321xl 32x1 XGA / Audio Switcher Features

#	Feature	Function
6	REMOTE Terminal Block Connectors	Connect to the remote contact-closure switches
7	AUDIO OUTPUT Terminal Block Connector	Connect to the balanced audio acceptor
8	AUDIO INPUTS Terminal Block Connectors	Connect to the balanced audio sources (from 1 to 32)
9	RS-232 IN DB 9F Port	Connects to the PC or RS-232 remote controller
10	RS-232 OUT DB 9M Port	Connects to the RS-232 IN DB 9F port of the next unit in the daisy-chain
11	RS-485 Detachable Terminal Block Port	Pin # 1 is for Ground connection, and Pins # 2 and # 3 are for RS-485
12	Power Connector with FUSE	AC connector enabling power supply to the unit
13	SETUP Dipswitches	Dipswitches for setup of the unit
14	ID BIT Switch	Selects the ID BIT when switched ON (when outputting the input signal from a notebook connected to an external VGA monitor) ²
15	INPUT HD15F Connectors	Connect to the VGA/XGA sources (from 1 to 32)
16	OUTPUT HD15F Connector	Connects to the VGA/XGA acceptor

1 If the AUDIO and VIDEO buttons both illuminate, the unit operates in the audio-follow-video mode. If only one button illuminates (AUDIO or VIDEO), the unit operates in the breakaway mode

2 Sometimes notebook computers refuse to output a VGA signal to an external VGA monitor if they do not detect the ID BIT as ON. Set the ID BIT to ON using this button so that the notebook will output to an external VGA monitor

5 Connecting an XGA / Audio Switcher

To connect the **VP-81xl**, **VP-161xl**, or **VP-321xl** unit, do the following¹:

- Connect the audio input and output cables (see section 5.1), the video input and output cables, and the power cord
- Set the dipswitches (see section 5.4)

You can choose to connect the following options:

- A PC or other RS-232 controller (see section 5.2)
- An RS-485 controller (see section 5.3)
- Remote contact-closure switches to the REMOTE connector (see section 5.5)

5.1 Connecting the Balanced/Unbalanced Stereo Audio Input/Output

Figure 4 illustrates how to wire a balanced input/output connection on the **VP-81xl**, **VP-161xl**, and/or **VP-321xl** unit:

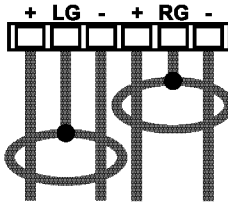

Figure 4: Connecting the Balanced Stereo Audio Input/Output

Figure 5 illustrates how to wire an unbalanced input/output on the **VP-81xl**, **VP-161xl**, and/or **VP-321xl** unit:

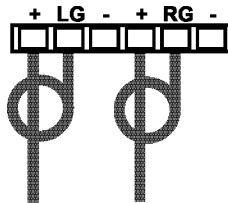

Figure 5: Connecting the Unbalanced Stereo Audio Input/Output

¹ Be sure that the power is switched OFF on each device before connecting it to your unit(s). After connecting all the devices to your unit(s), switch on the power of the unit(s), and then switch on the power of each device

5.2 Controlling via RS-232

To connect a PC to the **VP-81xl**, **VP-161xl**, or **VP-321xl** unit, using the Null-modem adapter provided with the machine (recommended):

- Connect the RS-232 IN DB9 rear panel port on the **VP-81xl**, **VP-161xl**, or **VP-321xl** unit to the Null-modem adapter and connect the Null-modem adapter with a 9-wire flat cable to the RS-232 DB9 port on your PC

To connect a PC to the **VP-81xl**, **VP-161xl**, or **VP-321xl** unit, without using a Null-modem adapter:

- Connect the RS-232 IN DB9 port on your PC to the RS-232 DB9 rear panel port on the **VP-81xl**, **VP-161xl**, or **VP-321xl** unit, as Figure 6 illustrates (depending on whether the PC has a 9-pin or 25-pin connector)

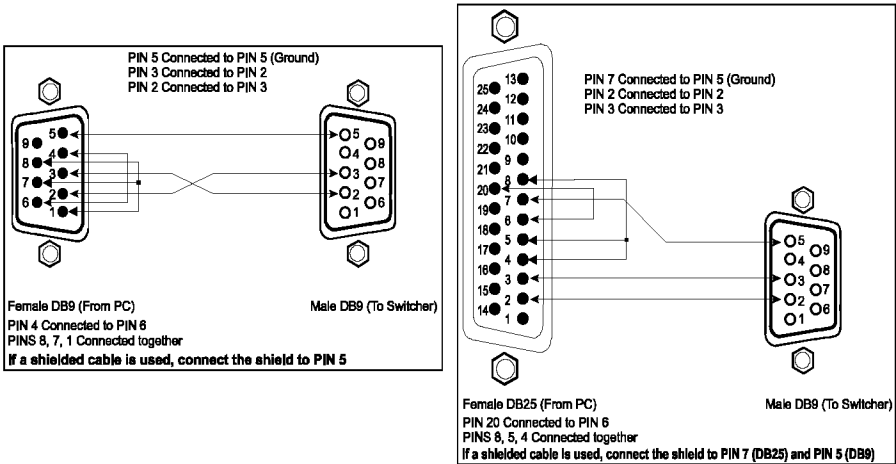

Figure 6: Connecting a PC without using a Null-modem Adapter

5.3 Controlling via RS-485

You can control a **VP-81xl**, **VP-161xl**, or **VP-321xl** unit(s) via any RS-485 remote controller or a PC (equipped with an RS-485 interface).

To connect an RS-485 remote controller to two **VP-81xl/VP-161xl/VP-321xl** units (see Figure 7):

1. Connect the RS-485 port on the RS-485 remote controller to the RS-485 ports on the **VP-81xl/VP-161xl/VP-321xl** units, as follows:
 - Connect the “A” (+) PIN on the RS-485 remote controller to the “+” (A) PINs on the RS-485 ports of the **VP-81xl/VP-161xl/VP-321xl** units
 - Connect the “B” (-) PIN on the RS-485 remote controller to the “B” (-) PINs on the RS-485 ports of the **VP-81xl/VP-161xl/VP-321xl** units
 - If shielded twisted pair cable is used, the shield may be connected to the “G” (Ground) PIN on one of the units (for example, on the RS-485 remote controller)
2. Set the SETUP dipswitches on the **VP-81xl/VP-161xl/VP-321xl** units as follows:
 - Set the first **VP-81xl/VP-161xl/VP-321xl** unit to MACHINE # 1¹
 - Set the second **VP-81xl/VP-161xl/VP-321xl** unit to MACHINE # 2¹ and set DIP 12 to ON, terminating the RS-485 line²

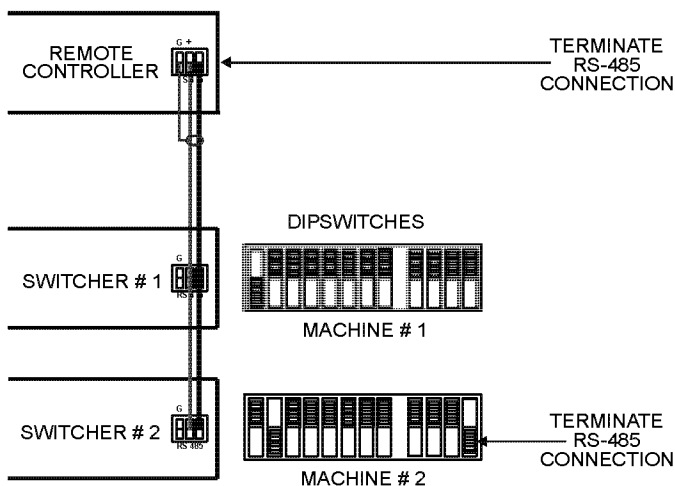

Figure 7: Controlling via RS-485

¹ See Table 8

² The RS-485 line must also be terminated at the remote controller. Refer to the remote controller's user manual for details of how to terminate the RS-485 line on the remote controller

5.4 Dipswitch Settings

Configure the **VP-81xl**, **VP-161xl**, and/or **VP-321xl** unit by setting the 12 SETUP dipswitches (item 13 on the rear panel), as Figure 8 and Table 7 define:

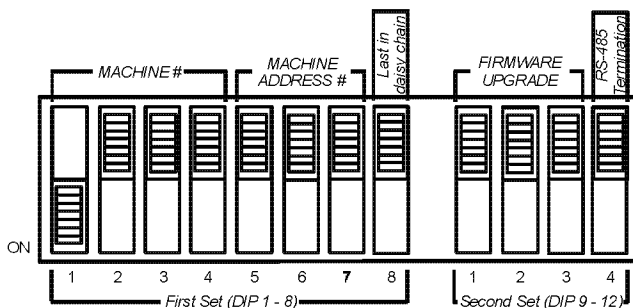

Figure 8: SETUP Dipswitches (Factory Default for Stand-Alone MACHINE # 1)

Table 7: Dipswitch Definitions

DIP	Function:
1-4	Set the MACHINE # (see section 5.4.1)
5-7	MACHINE ADDRESS # in daisy chain connection (see section 5.4.2)
8	Last in daisy chain
9-11 (marked 1-3 on second set)	Firmware Upgrade (see section 7)
12 (marked 4 on second set)	RS-485 Termination (see section 5.3)

5.4.1 Setting the MACHINE

To control a unit via RS-232 or RS-485, each unit has to be identified via its unique MACHINE #. Set the MACHINE # on a **VP-81xl**, **VP-161xl**, and/or **VP-321xl** unit according to Table 8. A valid MACHINE # is from 1 to 15. For a single, stand-alone machine, set as MACHINE # 1.

Table 8: MACHINE # Dipswitch Settings

MACHINE #	DIP 1	DIP 2	DIP 3	DIP 4
1	ON	OFF	OFF	OFF
2	OFF	ON	OFF	OFF
3	ON	ON	OFF	OFF
4	OFF	OFF	ON	OFF
5	ON	OFF	ON	OFF
6	OFF	ON	ON	OFF
7	ON	ON	ON	OFF
8	OFF	OFF	OFF	ON
9	ON	OFF	OFF	ON
10	OFF	ON	OFF	ON
11	ON	ON	OFF	ON
12	OFF	OFF	ON	ON
13	ON	OFF	ON	ON
14	OFF	ON	ON	ON
15	ON	ON	ON	ON

Figure 9 illustrates how to set the dipswitches on four single **VP-81xl**, **VP-161xl**, and/or **VP-321xl** units, which are controlled by one RS-232 port:

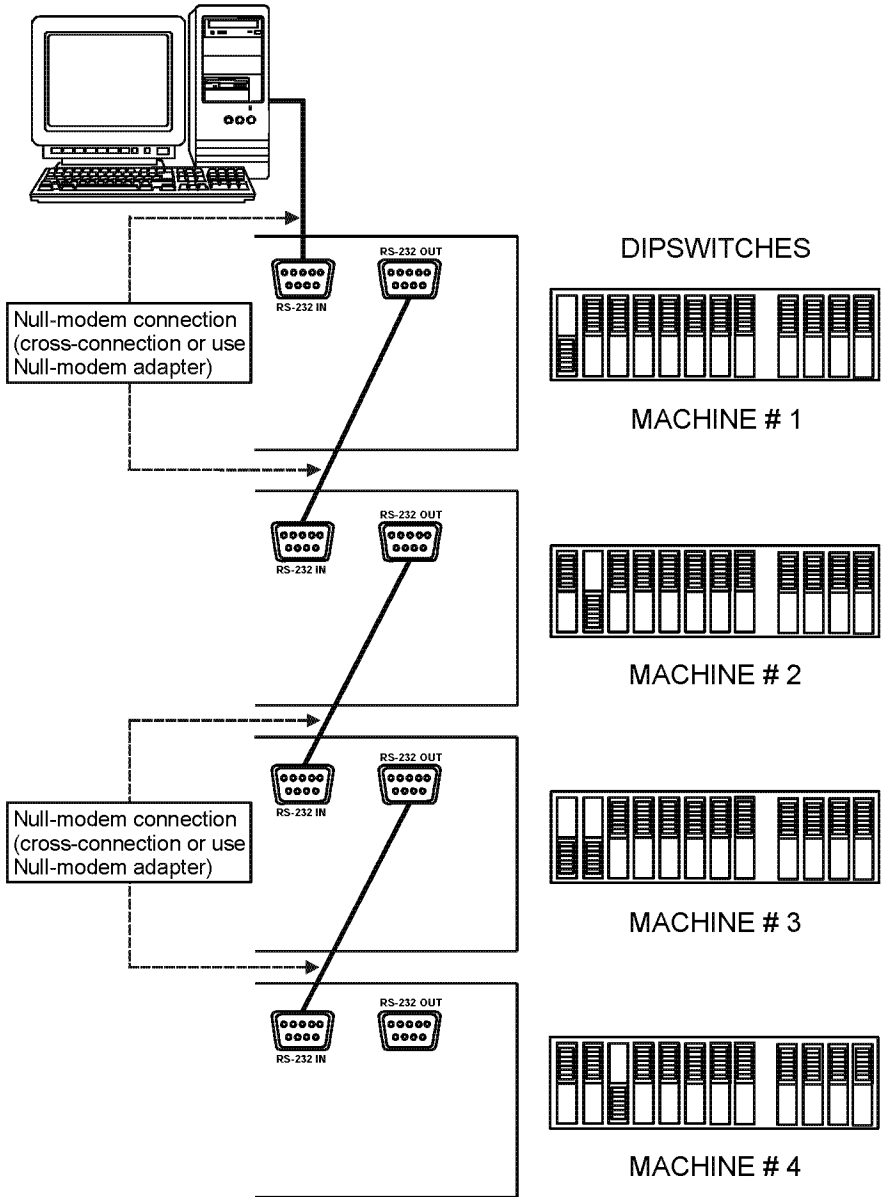

Figure 9: Dipswitch Settings on 4 VP-81xl, VP-161xl, and/or VP-321xl Units

5.4.2 Setting the MACHINE ADDRESS

For certain applications, you may need more than 8 inputs¹. Cascading the inputs of **VP-81xl/VP-161xl/VP-321xl** units enables you to expand the number of inputs by looping up to seven units to form a combined XGA / Audio Switcher with up to 218 inputs. Be aware that:

- Cascading **VP-81xl/VP-161xl/VP-321xl** units can cause XGA signal quality degradation
- Choosing the quantity of **VP-81xl/VP-161xl/VP-321xl** units to cascade depends on your particular XGA signal quality requirements
- The technical specifications contained in Table 10 are guaranteed for stand-alone units only

To cascade up to seven identical² units, that is, seven **VP-81xl** units, or seven **VP-161xl** units, or seven **VP-321xl** units:

- Set the same MACHINE # on each unit, according to Table 8
- Set the MACHINE ADDRESS # and the eighth dipswitch (last in daisy-chain) on each unit that is included in a set, according to Table 9

1 For example, if you want to connect 50 VGA/XGA audio sources and then be able to switch any one of them at any time

2 Only the same types of units (for example, seven VP-161xl units) can be cascaded – you cannot mix the various types (a cascade cannot include say, four VP-81xl units, and three VP-161xl units)

Connecting an XGA / Audio Switcher

Table 9: MACHINE ADDRESS # Dipswitch Settings

INPUTS AVAILABLE ON THE:			MACHINE ADDRESS #	DIP 5	DIP 6	DIP 7	DIP 8
VP-81xl	VP-161xl	VP-321xl					
8	16	32	1	OFF	OFF	OFF	OFF
15	31	63	1	ON	OFF	OFF	OFF
			2	OFF	ON	OFF	ON
22	46	94	1	ON	OFF	OFF	OFF
			2	OFF	ON	OFF	OFF
			3	ON	ON	OFF	ON
29	61	125	1	ON	OFF	OFF	OFF
			2	OFF	ON	OFF	OFF
			3	ON	ON	OFF	OFF
			4	OFF	OFF	ON	ON
36	76	156	1	ON	OFF	OFF	OFF
			2	OFF	ON	OFF	OFF
			3	ON	ON	OFF	OFF
			4	OFF	OFF	ON	OFF
			5	ON	OFF	ON	ON
43	91	187	1	ON	OFF	OFF	OFF
			2	OFF	ON	OFF	OFF
			3	ON	ON	OFF	OFF
			4	OFF	OFF	ON	OFF
			5	ON	OFF	ON	OFF
			6	OFF	ON	ON	ON
50	106	218	1	ON	OFF	OFF	OFF
			2	OFF	ON	OFF	OFF
			3	ON	ON	OFF	OFF
			4	OFF	OFF	ON	OFF
			5	ON	OFF	ON	OFF
			6	OFF	ON	ON	OFF
			7	ON	ON	ON	ON

5.4.3 Example: Connecting a Set of Three Cascaded VP-81xl Units

In this example, 22 inputs are connected using three looped **VP-81xl** units, with control via a single RS-232 port. You can route any one of the 22 inputs to the XGA / Audio acceptor, as Figure 10 illustrates¹.

To connect a set of three looped **VP-81xl** units with 22 inputs, do the following:

1. On the first **VP-81xl** unit, connect the:
 - XGA HD15F OUTPUT connector to the XGA INPUT 1 HD15F connector on the second **VP-81xl** unit
 - AUDIO OUTPUT terminal block connector to the Audio INPUT 1 terminal block connector on the second **VP-81xl** unit
2. On the second **VP-81xl** unit, connect the:
 - XGA HD15F OUTPUT connector to the XGA INPUT 1 HD15F connector on the third **VP-81xl** unit
 - AUDIO OUTPUT terminal block connector to the Audio INPUT 1 terminal block connector on the third **VP-81xl** unit
3. On the third **VP-81xl** unit, connect the:
 - XGA HD15F OUTPUT connector and the AUDIO OUTPUT terminal block connector to the XGA/Audio acceptor
4. Connect the XGA HD15F INPUT connectors 1 to 8 and the Audio INPUT terminal block connectors 1 to 8 on the first looped **VP-81xl** unit to the XGA/Audio sources 1 to 8.
5. Connect the XGA HD15F INPUT connectors 2 to 8 and the Audio INPUT terminal block connectors 2 to 8 on the:
 - Second looped **VP-81xl** unit to the XGA/Audio sources 9 to 15
 - Third looped **VP-81xl** unit to the XGA/Audio sources 16 to 22
6. Set the dipswitches as per Table 8 and Table 9. In particular, set:
 - Each **VP-81xl** unit to MACHINE # 1
 - The first **VP-81xl** unit to MACHINE ADDRESS # 1, the second **VP-81xl** unit to MACHINE ADDRESS # 2, and the third **VP-81xl** unit to MACHINE ADDRESS # 3
 - DIP 8 on the third (and *Last in Daisy-chain*) **VP-81xl** unit to ON
7. Control via RS-485 (see Figure 7) or via RS-232 (see Figure 9).

¹ Only the video connections are shown. Audio should be connected in a similar manner

Connecting an XGA / Audio Switcher

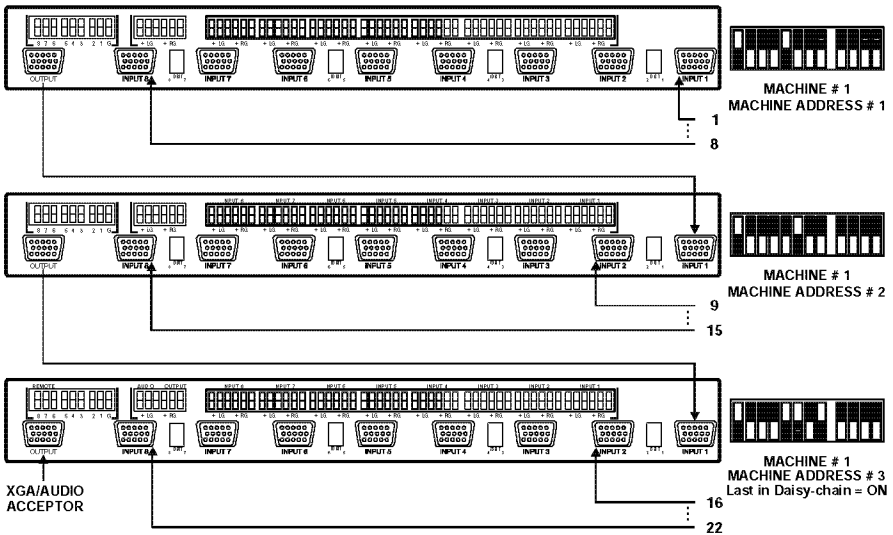

Figure 10: An Interconnected Set of Three Looped VP-81xl Units (Video Connections Shown)

5.5 Connecting the REMOTE Terminal Block¹ Connector

Connect remote contact-closure switches to the REMOTE terminal block connector, for example to a single XGA/Audio switcher such as the **VP-81xl**, as Figure 11 describes. A remote unit can consist of a mechanical switch² with a common wire³.

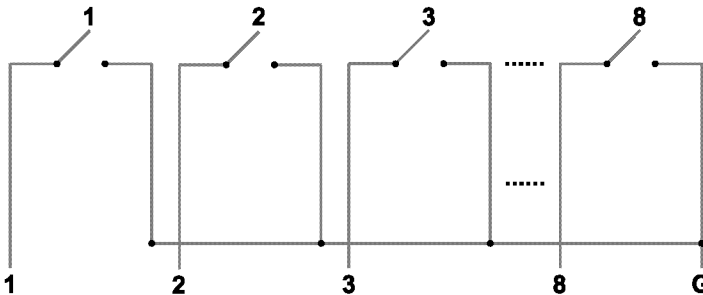

Figure 11: Connecting a Remote Mechanical Switcher Unit to the VP-81xl

1 The REMOTE terminal block connector has 8 pins (plus the G pin) on the VP-81xl, 16 pins on the VP-161xl, and 32 pins on the VP-321xl

2 The remote unit can have up to 8 buttons for the VP-81xl, corresponding to the front panel INPUT SELECTOR buttons. Similarly, 16 buttons for the VP-161xl, and 32 buttons for the VP-321xl

3 Providing control over a distance up to hundreds of meters

You can also connect remote contact-closure switches to the REMOTE terminal block connectors (according to Table 9). The example in Figure 12 illustrates how to connect remote contact-closure switches to the REMOTE terminal block connectors on a set of three looped VP-81xl units:

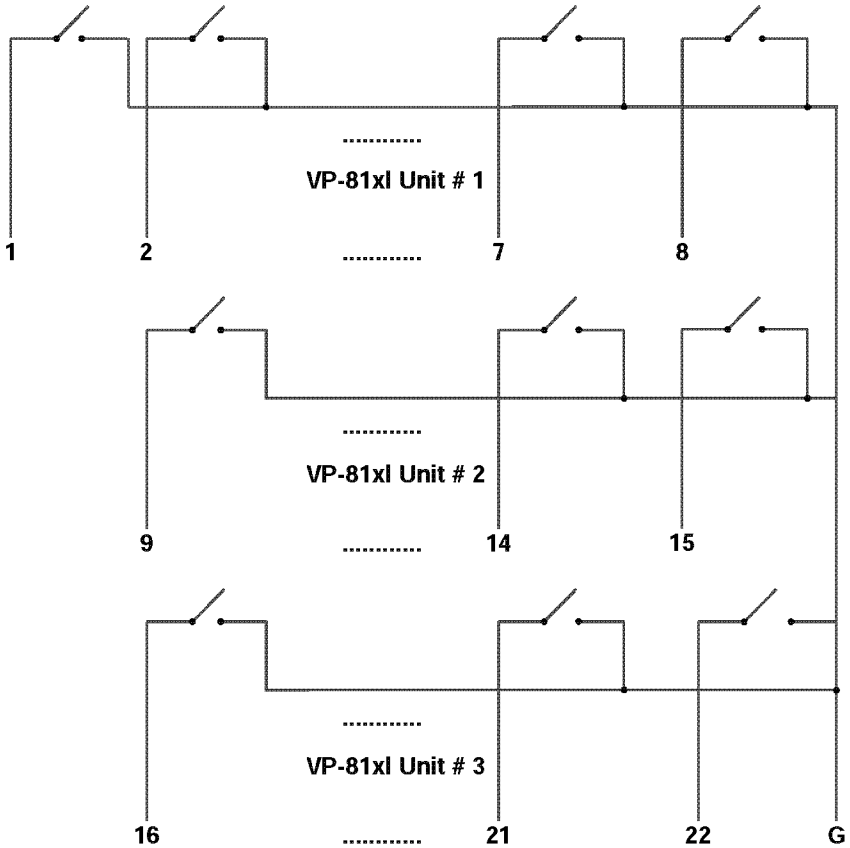

Figure 12: Connecting a Remote Unit to a Cascaded Set of Three VP-81xl Units

6 Operating Your XGA / Audio Switcher

You can operate your XGA / Audio Switcher, whether it consists of a single **VP-81xl/VP-161xl/VP-321xl** unit, or of a set of **VP-81xl/VP-161xl/VP-321xl** units, via the following:

- The front panel INPUT SELECTOR buttons, as section 6.1 describes
- Remotely, by RS-485 or RS-232 serial commands transmitted by a touch screen system, PC, or other serial controller
- Remote contact-closure switches (see section 5.5)
- Remotely, from the Kramer **RC-IR1** Infra-Red Remote Control Transmitter¹ (refer to the **RC-IR1** user manual²)

Powering up **VP-81xl/VP-161xl/VP-321xl** unit, recalls the previous settings (that is, the state of the unit when it was powered down) from the non-volatile memory.

6.1 Using the Front Panel INPUT SELECTOR Buttons

To use the INPUT SELECTOR buttons on a:

- Single **VP-81xl/VP-161xl/VP-321xl** unit, see section 6.1.1
- Set of looped **VP-81xl/VP-161xl/VP-321xl** units, see section 6.1.2

6.1.1 Using the INPUT SELECTOR Buttons on a Single Unit

To operate the INPUT SELECTOR buttons on a single **VP-81xl/VP-161xl/VP-321xl** unit:

- Press one of the 8 front panel INPUT SELECTOR buttons on the front panel of a **VP-81xl/VP-161xl/VP-321xl** unit
The INPUT SELECTOR button illuminates and routes that input to the output

6.1.2 Using the INPUT SELECTOR Buttons on a Set of Units

When operating a set of up to seven looped **VP-81xl/VP-161xl/VP-321xl** units, not all the INPUT SELECTOR buttons on the front panels of the combined **VP-81xl/VP-161xl/VP-321xl** units are active.

For example, as Figure 13 illustrates, with a combination of three **VP-81xl** units, you cannot use all the 8 INPUT SELECTOR buttons on each looped **VP-81xl** unit.

¹ Previously known as the IR-1/IR-1-01

² Download up-to-date Kramer user manuals from our Web site at: <http://www.kramerelectronics.com>

INPUT SELECTOR buttons 1 on the second and third units are inactive. You cannot connect INPUT 1 on the second and third units to an independent source because INPUT 1 on the second unit is connected to the OUTPUT on the first unit and INPUT 1 on the third unit is connected to the OUTPUT on the second unit.

INPUT SELECTOR buttons marked 1 to 8 on the first looped **VP-81xl** unit operate INPUTS 1 to 8, respectively. INPUT SELECTOR buttons marked 2 to 8 on the second looped **VP-81xl** unit operate INPUTS 9 to 15, respectively. INPUT SELECTOR buttons marked 2 to 8 on the third looped **VP-81xl** unit operate INPUTS 16 to 22, respectively.

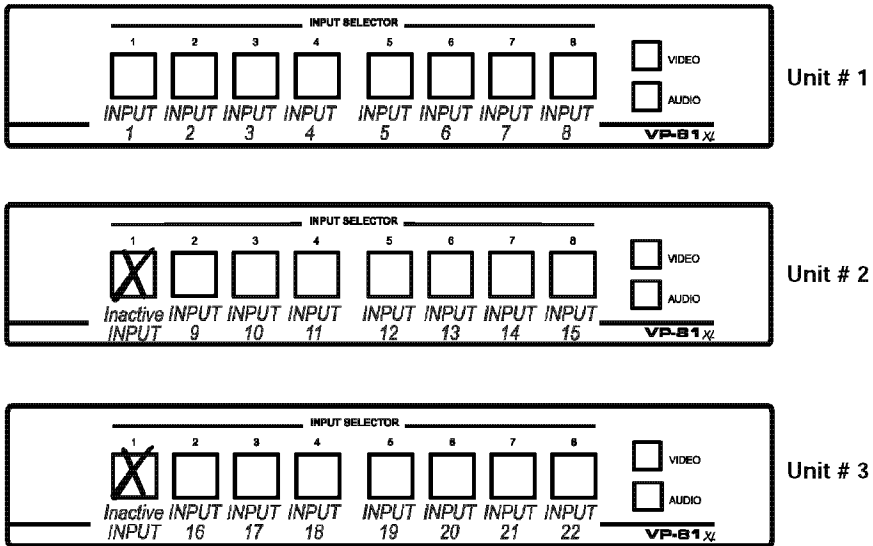

Figure 13: Operating a 22x1 XGA / Audio Switcher (Three Looped VP-81xl Units)

To operate the INPUT SELECTOR buttons on a set of three **VP-81xl** units:

- Press an active INPUT SELECTOR button on the front panel of one of the looped **VP-81xl** units

The active INPUT SELECTOR button illuminates and switches that input to the output. For example, as the example in Figure 13 illustrates, pressing INPUT SELECTOR button # 3 on **VP-81xl** unit # 2 automatically switches source # 10 to the output

6.1.3 Using the Audio-Follow-Video (AFV) / Breakaway Modes

By default, a **VP-81xl/VP-161xl/VP-321xl** unit, or set of units, switches in true audio-follow-video mode in which all operations relate to both the video and audio. Both the VIDEO and the AUDIO buttons illuminate in this mode.

6.1.3.1 Operating in Breakaway Mode

To operate in breakaway mode, in which video and audio channels switch independently:

- Press either the VIDEO button or the AUDIO button (only one button, the VIDEO button or the AUDIO button illuminate at this time)
If the VIDEO button illuminates, the switching relates just to video (and the audio remains unchanged)
If the AUDIO button illuminates, the switching relates only to audio (and the video remains unchanged)

6.1.3.2 Toggling between Video and Audio Control in Breakaway Mode

To toggle between video and audio control, press the corresponding button:

- For audio, press the AUDIO button
This selects audio, illuminating the AUDIO button (the VIDEO button will not illuminate), or
- For video, press the VIDEO button
This selects video, illuminating the VIDEO button (the AUDIO button will not illuminate)

6.1.3.3 Operating in the Audio-Follow-Video Mode

To operate in audio-follow-video (AFV) mode¹, press both the VIDEO and the AUDIO buttons simultaneously.

¹ In which the AUDIO and VIDEO buttons both illuminate. If only one button illuminates (AUDIO or VIDEO), the unit operates in the breakaway mode

7 Flash Memory Upgrade

The **VP-81xl/VP-161xl/VP-321xl** firmware is located in FLASH memory, which lets you upgrade to the latest Kramer firmware version in minutes! The process involves:

- Downloading from the Internet (see section 7.1)
- Connecting the PC to the RS-232 port (see section 7.2)
- Upgrading firmware (see section 2)

7.1 Downloading from the Internet

You can download the up-to-date file from the Internet. To do so:

1. Go to our Web site at <http://www.kramerelectronics.com> and download the appropriate file¹ from the Technical Support section. The same file is applicable to all models (**VP-81xl**, **VP-161xl** and/or **VP-321xl**). The program automatically recognizes the size of the switcher.
2. Extract the downloaded file to a folder (for example, C:\Program Files\Kramer Flash).

7.2 Connecting the PC to the RS-232 Port

Before installing the latest Kramer firmware version on a **VP-81xl/VP-161xl/VP-321xl** unit, do the following:

1. Connect the RS-232 DB9 rear panel port on the **VP-81xl/VP-161xl/VP-321xl** unit to the Null-modem adapter and connect the Null-modem adapter with a 9 wire flat cable to the RS-232 DB9 COM port on your PC (see section 5.2). It is recommended that you use COM port². However, if your computer has only one COM port, open the configuration file³ (located at C:\Program Files\Kramer Flash) in **Notepad**, and change “*set port COM2*” to “*set port COM1*”.

1 For example, “*FLIP_VP_81632.zip*”

2 The software is preset for use with COM port 2

3 For example, “*VP_81632.cfg*”

2. Do the following according to the **sequence below**:
 - **Connect the power cord and turn the POWER switch ON**
 - **Set DIP 9 ON**
 - **Set DIP 10 ON**
 - **Set DIP 12 ON**
 - **Set DIP 11 ON**
 - **After a few seconds, set DIP 11 OFF**

The front panel buttons may illuminate erratically. This is normal, and should be ignored.

7.3 Upgrading Firmware

Follow these steps to upgrade the firmware:

1. Double click the desktop icon: “*Shortcut to FLIP.EXE*” .
The Splash screen appears as follows:

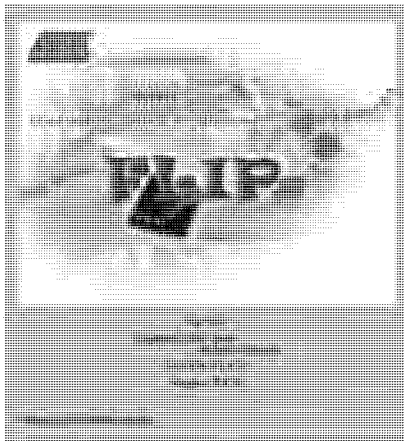

Figure 14: Splash Screen

2. After a few seconds, the Splash screen is replaced by the “*Atmel – Flip*” window:

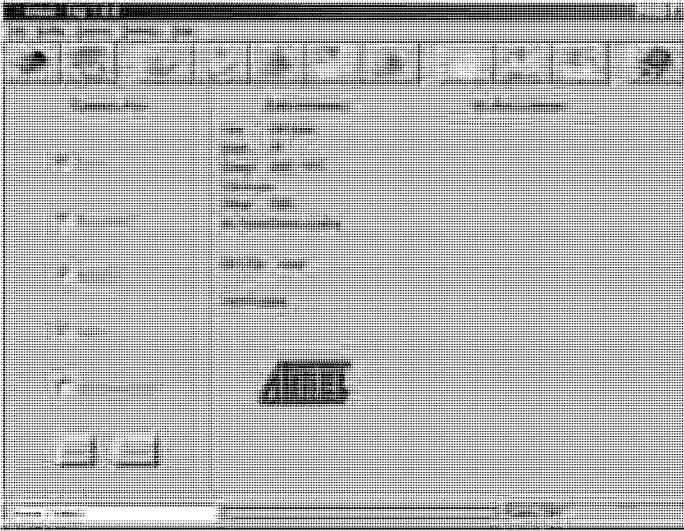

Figure 15: Atmel – Flip Window

3. Press the keyboard shortcut key *F4* (or select the “*Read Configuration File*” command from the *File* menu, or press the keys: *Alt FR*). The “*Open Configuration File*” window appears:

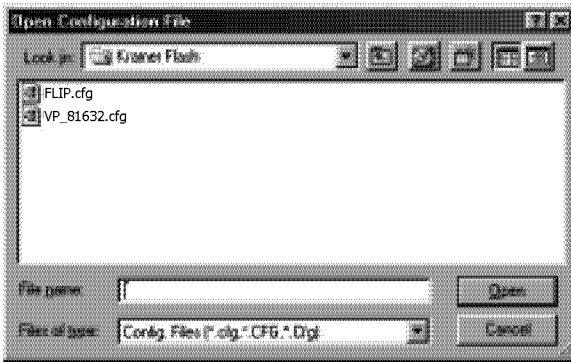

Figure 16: Open Configuration File Select Window

4. Choose the file: *VP_81632.cfg* (by double-clicking it). If COM 2 was not selected (see section 7.2), an RS-232 error message appears. In the “*Atmel – Flip*” window, the *Operations Flow* column is disabled, and crosses appear in the third column.

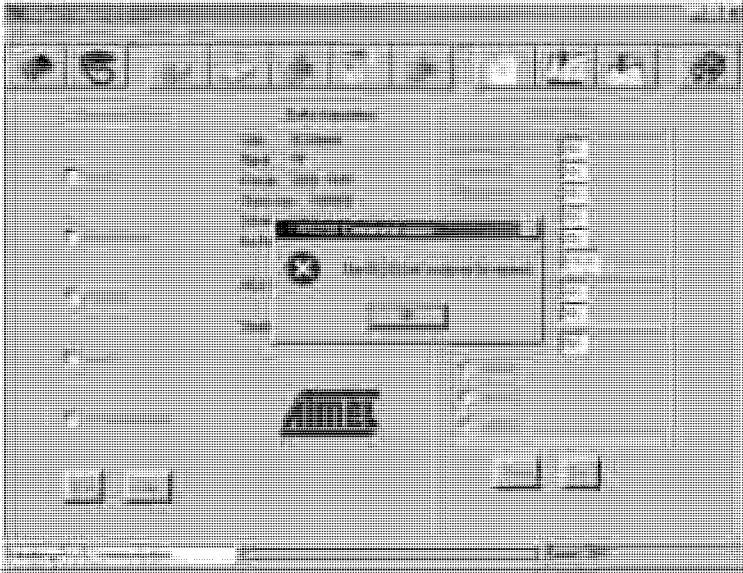

Figure 17: Atmel – Flip Window (RS-232 Communication)

5. Click OK and press the keyboard shortcut key *F3* (or select the “*Communication / RS232*” command from the *Settings* menu, or press the keys: *Alt SCR*).
The “*RS232*” window appears. Change the COM port:

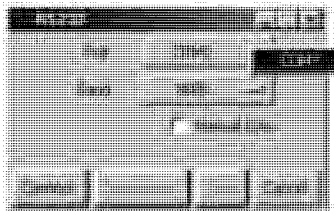

Figure 18: RS-232 Window

6. Click Connect.
In the “*Atmel – Flip*” window, in the *Operations Flow* column, the *Run* button is active, and the name of the chip appears as the name of the third column: *T89C51RB2*.
Verify that in the *Buffer Information* column, the appropriate Hex file¹ appears.

¹ For example, “*HEX File: VP_81632.hex*”

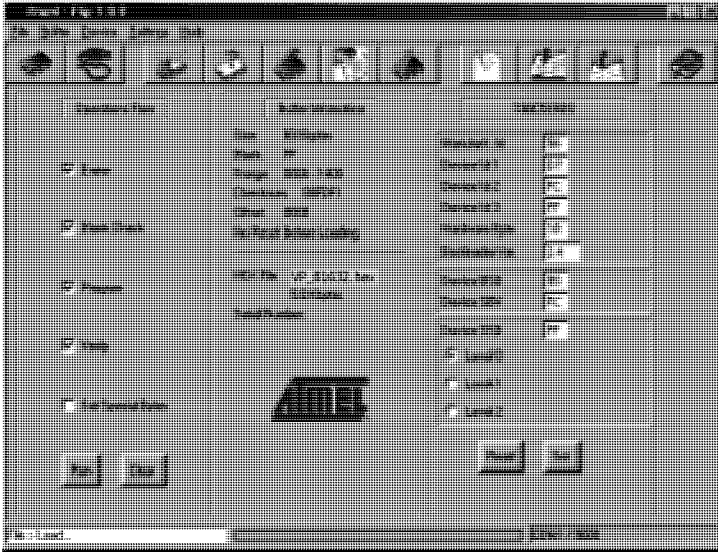

Figure 19: Atmel – Flip Window (Connected)

7. Click *Run*.
After each stage in the operation is completed, the check-box for that stage becomes colored green¹.
When the operation is completed, all 4 check-boxes will be colored green and the status bar message: *Memory Verify Pass* appears²:

1 See also the blue progress indicator on the status bar

2 If an error message: "Not Finished" shows, click Run again

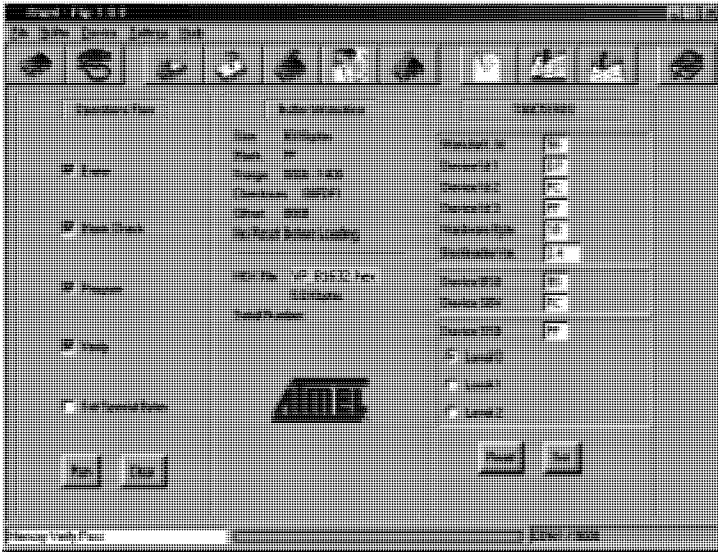

Figure 20: Atmel – Flip Window (Operation Completed)

8. Close the “Atmel – Flip” window.
9. Turn the **POWER** switch on the **VP-81xl/VP-161xl/VP-321xl** **OFF**.
10. Disconnect the RS-232 DB9 rear panel port on the **VP-81xl/VP-161xl/VP-321xl** unit from the Null-modem adapter.
11. Set **DIP 9 OFF**.
12. Set **DIP 10 OFF**.
13. Set **DIP 12 OFF**.
14. Turn the **POWER** switch on the **VP-81xl/VP-161xl/VP-321xl** **ON**.
Upon initialization, the **VP-81xl/VP-161xl/VP-321xl** will work with the new firmware version.

8 Technical Specifications

Table 10 includes the technical specifications:

Table 10: Technical Specifications¹ of the VP-81xl/VP-161xl/VP-321xl

INPUTS:	VP-81xl:	8 analog red, green, blue signals - 0.7Vpp / 75 Ω, H & V syncs, TTL level on HD15F connectors 8 balanced audio stereo signals, + 4dBm typ. on detachable terminal blocks	
	VP-161xl:	16 analog red, green, blue signals - 0.7Vpp / 75 Ω, H & V syncs, TTL level on HD15F connectors 16 balanced audio stereo signals, + 4dBm typ. on detachable terminal blocks	
	VP-321xl:	32 analog red, green, blue signals - 0.7Vpp / 75 Ω, H & V syncs, TTL level on HD15F connectors 32 balanced audio stereo signals, + 4dBm typ. on detachable terminal blocks	
OUTPUTS:	1 analog red, green, blue signals - 0.7Vpp / 75 Ω, H & V syncs, TTL level on an HD15F connector 1 balanced audio stereo signal, + 4dBm typ. on detachable terminal blocks		
MAX. INPUT/OUTPUT LEVEL:	VIDEO: 2Vpp	AUDIO: 26dBm	
BANDWIDTH (-3dB):	VP-81xl:	VIDEO: >500MHz	AUDIO: 100kHz
	VP-161xl:	VIDEO: >500MHz	
	VP-321xl:	VIDEO: >500MHz	
S/N RATIO:	VIDEO: 73dB	AUDIO: >83dB	
CROSSTALK (all hostile):	VIDEO: -47 dB@ 5MHz	AUDIO: -65dB@ 1kHz	
CONTROLS:	Front panel selector switches; RS-232, RS-485; IR remote control; detachable terminal blocks for remote dry-contact switches		
COUPLING:	VIDEO: DC	AUDIO: DC	
AUDIO THD + NOISE:	<0.025%		
AUDIO 2nd HARMONIC:	<0.003%		
POWER SOURCE:	230 VAC, 50/60 Hz, (115VAC, U.S.A.) 12VA max		
DIMENSIONS:	VP-81xl:	19-inch (W), 7-inch (D) 1U (H) rack-mountable	
	VP-161xl:	19-inch (W), 7-inch (D) 2U (H) rack-mountable	
	VP-321xl:	19-inch (W), 7-inch (D) 4U (H) rack-mountable	
WEIGHT:	VP-81xl	2.7 kg (6 lbs.) approx	
	VP-161xl:	3.4 kg (7.5 lbs.) approx	
	VP-321xl:	5.5 kg (12.2 lbs.) approx	
ACCESSORIES:	Power cord, Null modem adapter, Windows®-based Kramer control software, Infra-red remote control transmitter		

¹ Specifications are subject to change without notice

9 Table of Hex Codes for Serial Communication

Table 11 lists the Hex values for a single **VP-81xl/VP-161xl/VP-321xl** machine. For more detailed information, see Protocol 2000¹.

Table 11: VP-81xl/VP-161xl/VP-321xl Hex Codes

	OUT		OUT		OUT		OUT
IN 1	01 81 81 81	IN 9	01 89 81 81	IN 17	01 91 81 81	IN 25	01 99 81 81
IN 2	01 82 81 81	IN 10	01 8A 81 81	IN 18	01 92 81 81	IN 26	01 9A 81 81
IN 3	01 83 81 81	IN 11	01 8B 81 81	IN 19	01 93 81 81	IN 27	01 9B 81 81
IN 4	01 84 81 81	IN 12	01 8C 81 81	IN 20	01 94 81 81	IN 28	01 9C 81 81
IN 5	01 85 81 81	IN 13	01 8D 81 81	IN 21	01 95 81 81	IN 29	01 9D 81 81
IN 6	01 86 81 81	IN 14	01 8E 81 81	IN 22	01 96 81 81	IN 30	01 9E 81 81
IN 7	01 87 81 81	IN 15	01 8F 81 81	IN 23	01 97 81 81	IN 31	01 9F 81 81
IN 8	01 88 81 81	IN 16	01 90 81 81	IN 24	01 98 81 81	IN 32	01 A0 81 81

¹ Go to the Technical Support section of our Web site at <http://www.kramerelectronics.com>

LIMITED WARRANTY

Kramer Electronics (hereafter *Kramer*) warrants this product free from defects in material and workmanship under the following terms.

HOW LONG IS THE WARRANTY

Labor and parts are warranted for three years from the date of the first customer purchase.

WHO IS PROTECTED?

Only the first purchase customer may enforce this warranty.

WHAT IS COVERED AND WHAT IS NOT COVERED

Except as below, this warranty covers all defects in material or workmanship in this product. The following are not covered by the warranty:

1. Any product which is not distributed by Kramer, or which is not purchased from an authorized Kramer dealer. If you are uncertain as to whether a dealer is authorized, please contact Kramer at one of the agents listed in the Web site www.kramerelectronics.com.
2. Any product, on which the serial number has been defaced, modified or removed.
3. Damage, deterioration or malfunction resulting from:
 - i) Accident, misuse, abuse, neglect, fire, water, lightning or other acts of nature
 - ii) Product modification, or failure to follow instructions supplied with the product
 - iii) Repair or attempted repair by anyone not authorized by Kramer
 - iv) Any shipment of the product (claims must be presented to the carrier)
 - v) Removal or installation of the product
 - vi) Any other cause, which does not relate to a product defect
 - vii) Cartons, equipment enclosures, cables or accessories used in conjunction with the product

WHAT WE WILL PAY FOR AND WHAT WE WILL NOT PAY FOR

We will pay labor and material expenses for covered items. We will not pay for the following:

1. Removal or installations charges.
2. Costs of initial technical adjustments (set-up), including adjustment of user controls or programming. These costs are the responsibility of the Kramer dealer from whom the product was purchased.
3. Shipping charges.

HOW YOU CAN GET WARRANTY SERVICE

1. To obtain service on you product, you must take or ship it prepaid to any authorized Kramer service center.
2. Whenever warranty service is required, the original dated invoice (or a copy) must be presented as proof of warranty coverage, and should be included in any shipment of the product. Please also include in any mailing a contact name, company, address, and a description of the problem(s).
3. For the name of the nearest Kramer authorized service center, consult your authorized dealer.

LIMITATION OF IMPLIED WARRANTIES

All implied warranties, including warranties of merchantability and fitness for a particular purpose, are limited in duration to the length of this warranty.

EXCLUSION OF DAMAGES

The liability of Kramer for any effective products is limited to the repair or replacement of the product at our option. Kramer shall not be liable for:

1. Damage to other property caused by defects in this product, damages based upon inconvenience, loss of use of the product, loss of time, commercial loss; or:
2. Any other damages, whether incidental, consequential or otherwise. Some countries may not allow limitations on how long an implied warranty lasts and/or do not allow the exclusion or limitation of incidental or consequential damages, so the above limitations and exclusions may not apply to you.

This warranty gives you specific legal rights, and you may also have other rights, which vary from place to place.

NOTE: All products returned to Kramer for service must have prior approval. This may be obtained from your dealer.

This equipment has been tested to determine compliance with the requirements of:

- EN-50081: "Electromagnetic compatibility (EMC);
generic emission standard.
Part 1: Residential, commercial and light industry"
- EN-50082: "Electromagnetic compatibility (EMC) generic immunity standard.
Part 1: Residential, commercial and light industry environment".
- CFR-47: FCC Rules and Regulations:
Part 15: "Radio frequency devices
Subpart B – Unintentional radiators"

CAUTION!

- Servicing the machines can only be done by an authorized Kramer technician. Any user who makes changes or modifications to the unit without the expressed approval of the manufacturer will void user authority to operate the equipment.
- Use the supplied DC power supply to feed power to the machine.
- Please use recommended interconnection cables to connect the machine to other components.





For the latest information on our products and a list of Kramer distributors, visit our Web site: www.kramerelectronics.com, where updates to this user manual may be found. We welcome your questions, comments and feedback.

	Safety Warning:
Caution	Disconnect the unit from the power supply before opening/servicing.

