

Kramer Electronics, Ltd.



USER MANUAL

Model:

VP-200XLN

XGA Line Amplifier / DA

Contents

1	Introduction	1
2	Getting Started	1
2.1	Quick Start	1
3	Overview	3
4	Your VP-200XLN XGA Line Amplifier / DA	4
5	Connecting the VP-200XLN XGA Line Amplifier / DA	6
6	Technical Specifications	7

Figures

Figure 1:	VP-200XLN XGA Line Amplifier / DA	4
Figure 2:	VP-200XLN (Top Side Panel)	4
Figure 3:	VP-200XLN (Lower Side Panel)	4
Figure 4:	VP-200XLN XGA Line Amplifier / DA (Underside)	5
Figure 5:	Connecting the VP-200XLN XGA Line Amplifier / DA	6

Tables

Table 1:	VP-200XLN XGA Line Amplifier / DA Features	5
Table 2:	VP-200XLN XGA Line Amplifier / DA (Underside) Features	5
Table 3:	Technical Specifications of the VP-200XLN XGA Line Amplifier / DA	7

1 Introduction

Welcome to Kramer Electronics (since 1981): a world of unique, creative and affordable solutions to the infinite range of problems that confront the video, audio and presentation professional on a daily basis. In recent years, we have redesigned and upgraded most of our line, making the best even better! Our 500-plus different models now appear in 8 Groups¹, which are clearly defined by function. Congratulations on purchasing your Kramer TOOLS

VP-200XLN XGA Line Amplifier / DA, which is ideal for:

- Dual monitor systems, stores, and points of sale
- Presentation systems

The package includes the following items:

- **VP-200XLN XGA Line Amplifier / DA**
- Power adapter (12V DC Input) and this user manual²

2 Getting Started

We recommend that you:

- Unpack the equipment carefully and save the original box and packaging materials for possible future shipment
- Review the contents of this user manual
- Use Kramer high performance high resolution cables³

2.1 Quick Start

This quick start chart summarizes the basic setup and operation steps.

1 GROUP 1: Distribution Amplifiers; GROUP 2: Video and Audio Switchers, Matrix Switchers and Controllers; GROUP 3: Video, Audio, VGA/XGA Processors; GROUP 4: Interfaces and Sync Processors; GROUP 5: Twisted Pair Interfaces; GROUP 6: Accessories and Rack Adapters; GROUP 7: Scan Converters and Scalers; and GROUP 8: Cables and Connectors

2 Download up-to-date Kramer user manuals from the Internet at this URL: <http://www.kramerelectronics.com>

3 The complete list of Kramer cables is on our Web site at <http://www.kramerelectronics.com>

Step 1: Connect the inputs/outputs - see section 5

On the VP-200XLN, connect:

- A computer graphics source to the INPUT
- OUTPUT 1 to an acceptor (for example, a projector)
- OUTPUT 2 to an acceptor (for example, a display)

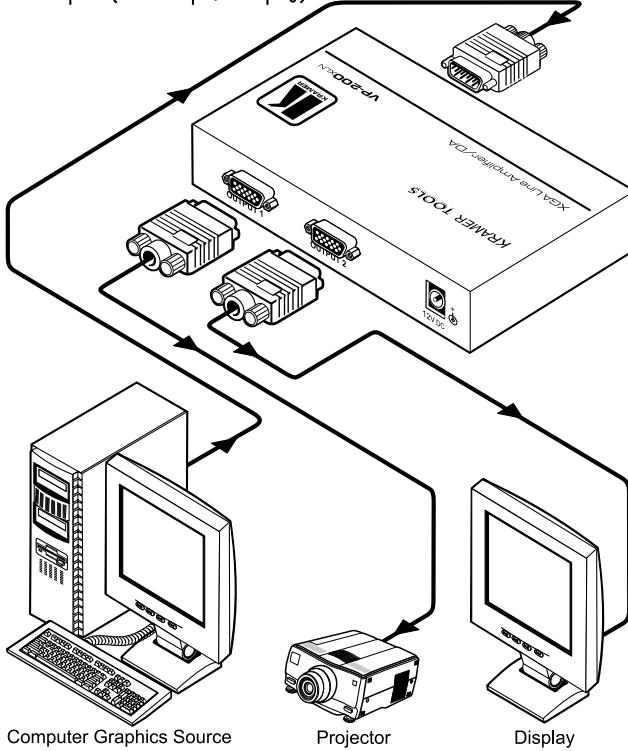

Step 2: Connect the power

Step 3: Adjust the potentiometers - see section 4

Adjust the EQ. and LEVEL potentiometers if required, using a screwdriver

Step 4: Set the underside switches - see section 4

Set the ID Bit:



Set the red, green and blue DC/AC coupling switches:

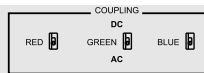

3 Overview

The high performance **VP-200XLN** is a 1:2 line amplifier / distribution amplifier for XGA¹ computer graphics signals that accepts one input, provides correct buffering and isolation, and then distributes the signal to two identical outputs.

In particular, the **VP-200XLN XGA Line Amplifier / DA** includes:

- High-density 15 pin D connectors
- Video bandwidth of 400MHz, ensuring that it remains transparent for all resolutions
- Separate controls for output level and cable equalization; ID Bit control, and independent DC or AC coupling for red, green and blue

Achieving the best performance means:

- Connecting only good quality connection cables, thus avoiding interference, deterioration in signal quality due to poor matching, and elevated noise levels (often associated with low quality cables)
- Avoiding interference from neighboring electrical appliances and positioning your **VP-200XLN** away from moisture, excessive sunlight and dust

¹ The terminology XGA is used throughout this manual, where this implies any RGBHV signal on an HD15 connector having a resolution from VGA up to UXGA

4 Your VP-200XLN XGA Line Amplifier / DA

Figure 1, Figure 2, Figure 3 and Table 1 define the **VP-200XLN**:

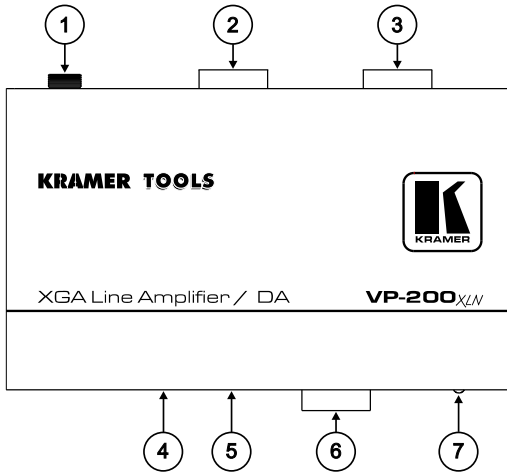

Figure 1: VP-200XLN XGA Line Amplifier / DA

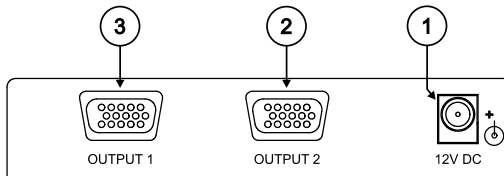

Figure 2: VP-200XLN (Top Side Panel)

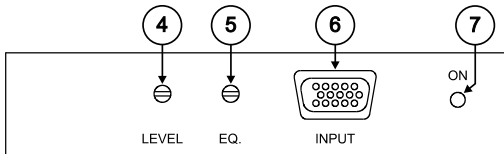

Figure 3: VP-200XLN (Lower Side Panel)

Table 1: VP-200XLN XGA Line Amplifier / DA Features

#	Feature	Function
1	12V DC	+12V DC connector for powering the unit
2	OUTPUT 2 HD15F Connector	Connect to the computer graphics acceptor 2
3	OUTPUT 1 HD15F Connector	Connect to the computer graphics acceptor 1
4	LEVEL Control Potentiometer	Adjusts ¹ the video signal level
5	EQ. Control Potentiometer	Adjusts ¹ the video EQ. (equalization) compensation
6	INPUT HD15F Connector	Connect to the computer graphics source
7	ONLED	Illuminates when receiving power

Figure 4 and Table 2 define the underside of the **VP-200XLN**:

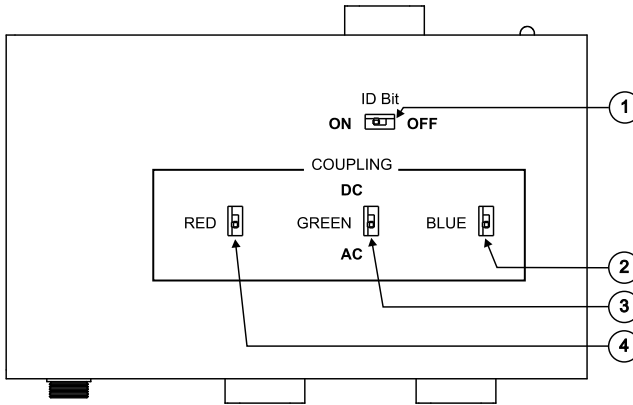

Figure 4: VP-200XLN XGA Line Amplifier / DA (Underside)

Table 2: VP-200XLN XGA Line Amplifier / DA (Underside) Features

#	Feature	Function	
1	ID Bit Switch	Slide to the left to set to ON ² ; to the right to set to OFF	
2	COUPLING	BLUE Switch	Slide up to set to DC; down to set to AC
3		GREEN Switch	
4		RED Switch	

1 Use a screwdriver to rotate the potentiometer, adjusting the appropriate level

2 The default. Enabling the notebook or laptop to output a VGA signal to an external VGA monitor

5 Connecting the VP-200XLN XGA Line Amplifier / DA

To connect your **VP-200XLN XGA Line Amplifier / DA**, as the example in Figure 5 illustrates, do the following¹:

1. Connect a computer graphics source (for example, a computer) to the INPUT HD15F connector.
2. Connect the OUTPUT HD15F connectors to up to 2 acceptors, as follows:
 - Connect the OUTPUT 1 to the acceptor 1 (for example, a projector)
 - Connect the OUTPUT 2 to the acceptor 2 (for example, a display)
3. Connect the 12V DC power adapter (wall transformer) to the 12V DC socket and connect the transformer to the mains electricity.
4. If required², adjust the video output signal level and/or cable compensation equalization level, and/or set the:
 - Red, green and blue coupling switches on the underside to DC or AC
 - ID Bit switch to ON

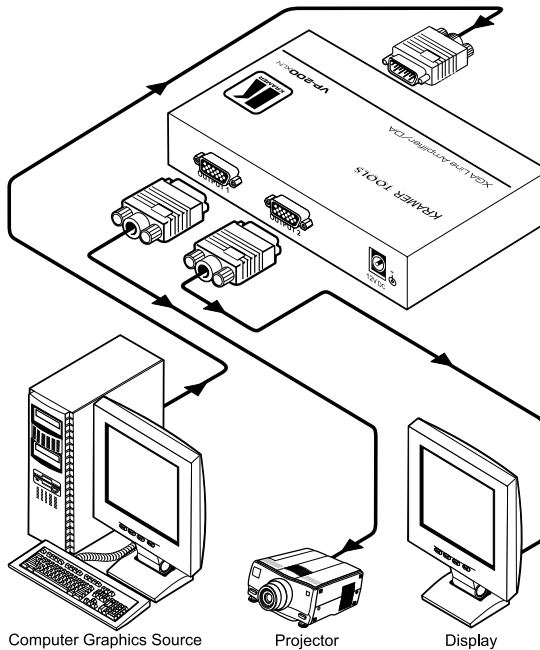

Figure 5: Connecting the VP-200XLN XGA Line Amplifier / DA

1 Switch OFF the power on each device before connecting it to your VP-200XLN. After powering up your VP-200XLN, switch on the power on each device

2 Use a screwdriver to rotate the potentiometer, adjusting the appropriate level

6 Technical Specifications

Table 3 includes the technical specifications:

Table 3: Technical Specifications¹ of the VP-200XLN XGA Line Amplifier / DA

INPUT:	1 XGA on an HD15F connector
OUTPUTS:	2 XGA on HD15F connectors
MAX. OUTPUT LEVEL:	2Vpp
BANDWIDTH (-3dB):	400MHz
DIFF. GAIN:	0.05%
DIFF. PHASE:	0.03°
K-FACTOR:	<0.05%
S/N RATIO:	71dB
CONTROLS:	Level: -1.5dB to +6.1dB, EQ.: 0 to +7.3dB @ 50MHz
COUPLING:	AC/DC
POWER SOURCE:	12 VDC, 95mA
DIMENSIONS:	12cm x 7.15cm x 2.76cm (4.7" x 2.8" x 1.08"), W, D, H
WEIGHT:	0.3 kg. (0.67 lbs.) approx.
ACCESSORIES:	Power supply, mounting bracket
OPTIONS:	19" rack adapters RK-T1, RK-T3

¹ Specifications are subject to change without notice

LIMITED WARRANTY

Kramer Electronics (hereafter *Kramer*) warrants this product free from defects in material and workmanship under the following terms.

HOW LONG IS THE WARRANTY

Labor and parts are warranted for seven years from the date of the first customer purchase.

WHO IS PROTECTED?

Only the first purchase customer may enforce this warranty.

WHAT IS COVERED AND WHAT IS NOT COVERED

Except as below, this warranty covers all defects in material or workmanship in this product. The following are not covered by the warranty:

1. Any product which is not distributed by Kramer, or which is not purchased from an authorized Kramer dealer. If you are uncertain as to whether a dealer is authorized, please contact Kramer at one of the agents listed in the web site www.kramerelectronics.com.
2. Any product, on which the serial number has been defaced, modified or removed.
3. Damage, deterioration or malfunction resulting from:
 - i) Accident, misuse, abuse, neglect, fire, water, lightning or other acts of nature
 - ii) Product modification, or failure to follow instructions supplied with the product
 - iii) Repair or attempted repair by anyone not authorized by Kramer
 - iv) Any shipment of the product (claims must be presented to the carrier)
 - v) Removal or installation of the product
 - vi) Any other cause, which does not relate to a product defect
 - vii) Cartons, equipment enclosures, cables or accessories used in conjunction with the product

WHAT WE WILL PAY FOR AND WHAT WE WILL NOT PAY FOR

We will pay labor and material expenses for covered items. We will not pay for the following:

1. Removal or installations charges.
2. Costs of initial technical adjustments (set-up), including adjustment of user controls or programming. These costs are the responsibility of the Kramer dealer from whom the product was purchased.
3. Shipping charges.

HOW YOU CAN GET WARRANTY SERVICE

1. To obtain service on you product, you must take or ship it prepaid to any authorized Kramer service center.
2. Whenever warranty service is required, the original dated invoice (or a copy) must be presented as proof of warranty coverage, and should be included in any shipment of the product. Please also include in any mailing a contact name, company, address, and a description of the problem(s).
3. For the name of the nearest Kramer authorized service center, consult your authorized dealer.

LIMITATION OF IMPLIED WARRANTIES

All implied warranties, including warranties of merchantability and fitness for a particular purpose, are limited in duration to the length of this warranty.

EXCLUSION OF DAMAGES

The liability of Kramer for any effective products is limited to the repair or replacement of the product at our option. Kramer shall not be liable for:

1. Damage to other property caused by defects in this product, damages based upon inconvenience, loss of use of the product, loss of time, commercial loss; or:
2. Any other damages, whether incidental, consequential or otherwise. Some countries may not allow limitations on how long an implied warranty lasts and/or do not allow the exclusion or limitation of incidental or consequential damages, so the above limitations and exclusions may not apply to you.

This warranty gives you specific legal rights, and you may also have other rights, which vary from place to place.

NOTE: All products returned to Kramer for service must have prior approval. This may be obtained from your dealer. This equipment has been tested to determine compliance with the requirements of:

EN-50081:	"Electromagnetic compatibility (EMC); generic emission standard. Part 1: Residential, commercial and light industry"
EN-50082:	"Electromagnetic compatibility (EMC) generic immunity standard. Part 1: Residential, commercial and light industry environment".
CFR-47:	FCC Rules and Regulations: Part 15: "Radio frequency devices Subpart B – Unintentional radiators"

CAUTION!

- ☒ Servicing the machines can only be done by an authorized Kramer technician. Any user who makes changes or modifications to the unit without the expressed approval of the manufacturer will void user authority to operate the equipment.
- ☒ Use the supplied DC power supply to feed power to the machine.
- ☒ Please use recommended interconnection cables to connect the machine to other components.



For the latest information on our products and a list of Kramer distributors, visit our Web site: www.kramerelectronics.com, where updates to this user manual may be found. We welcome your questions, comments and feedback.



Caution

Safety Warning:

Disconnect the unit from the power supply before opening/servicing.



Kramer Electronics, Ltd.

Web site: www.kramerelectronics.com

E-mail: info@kramerel.com

P/N: 2900-000207 REV 1