

Crestron **DM-DR**
DigitalMedia™ Repeater

Operations & Installation Guide



This document was prepared and written by the Technical Documentation department at:



Crestron Electronics, Inc.

15 Volvo Drive

Rockleigh, NJ 07647

1-888-CRESTRON

Contents

DigitalMedia™ Repeater: DM-DR	1
Introduction	1
Features and Functions	1
Applications.....	2
Specifications	3
Physical Description.....	4
Industry Compliance	8
Setup.....	9
Network Wiring.....	9
Installation.....	9
Hardware Hookup	11
Uploading and Upgrading.....	13
Establishing Communication.....	13
Firmware	13
Program Checks	14
Problem Solving	15
Troubleshooting.....	15
Check Network Wiring.....	16
Reference Documents.....	17
Further Inquiries	18
Future Updates	18
Return and Warranty Policies	19
Merchandise Returns / Repair Service	19
CRESTRON Limited Warranty.....	19

DigitalMedia™ Repeater: DM-DR

Introduction

The DigitalMedia™ (DM) Repeater allows DM cable lengths to be extended in up to 200 foot increments. Up to three repeaters may be installed in a single DM cable run to enable cable lengths up to 450 feet. Refer to the latest version of the Crestron® DigitalMedia Design Guide (Doc. 4789) for more information about DM wiring. It is available from the Crestron website (www.crestron.com/manuals).

The DM-DR does not simply boost the DM signal, but actually reproduces a fresh signal to ensure error-free delivery to the following device. Each DM Repeater mounts to a standard 2-gang, 85mm European or 4 inch 1900 box electrical box or plaster ring, and extends one inch (25.4 mm) from the wall surface when mounted.

Features and Functions

- Extends DigitalMedia or CAT5e/6 cable distance
- Regenerates HDMI signal
- Low-profile design
- Mounts to a 2-gang, European or 4 inch 1900 electrical box

Applications

The following diagram shows a DM-DR in a residential application.

DM-DR in a Residential Application

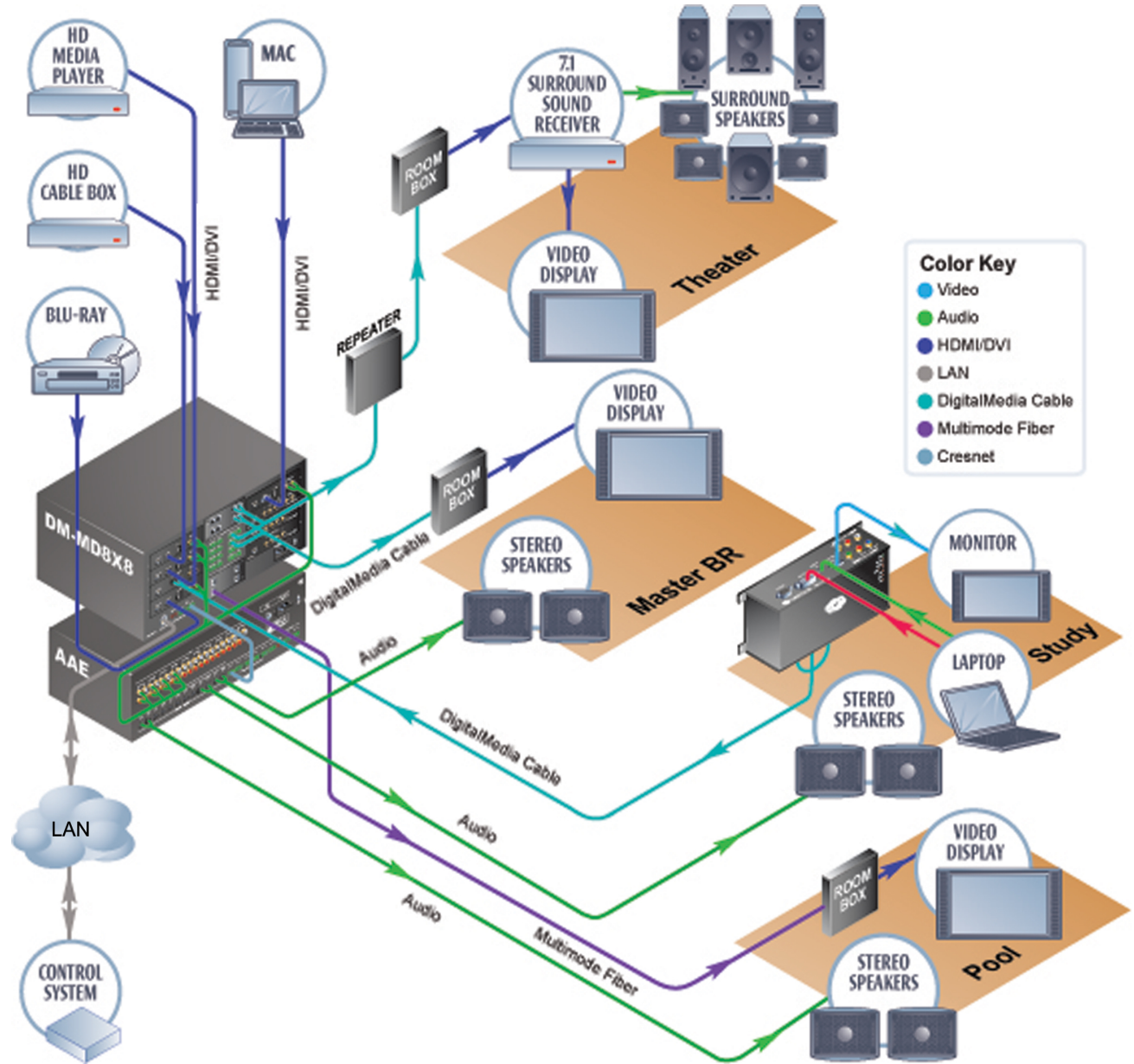

For more information on this and other DM applications, refer to the latest revision of the Crestron DigitalMedia Design Guide (Doc. 4789).

Specifications

Specifications for the DM-DR are listed in the following table.

DM-DR Specifications

SPECIFICATION	DETAILS
Power DMNet Power Usage	3 watts (0.13 Amps @ 24 Volts DC)
Environmental Temperature	41° to 104° F (5° to 40° C)
Humidity	10% to 90% RH (non-condensing)
Heat Dissipation	10 BTU/Hr
Dimensions Height	4.92 in (12.48 cm)
Width	5.25 in (13.34 cm)
Depth	1.40 in (3.55 cm)

Physical Description

This section provides information on the connections, controls and indicators available on your DM-DR.

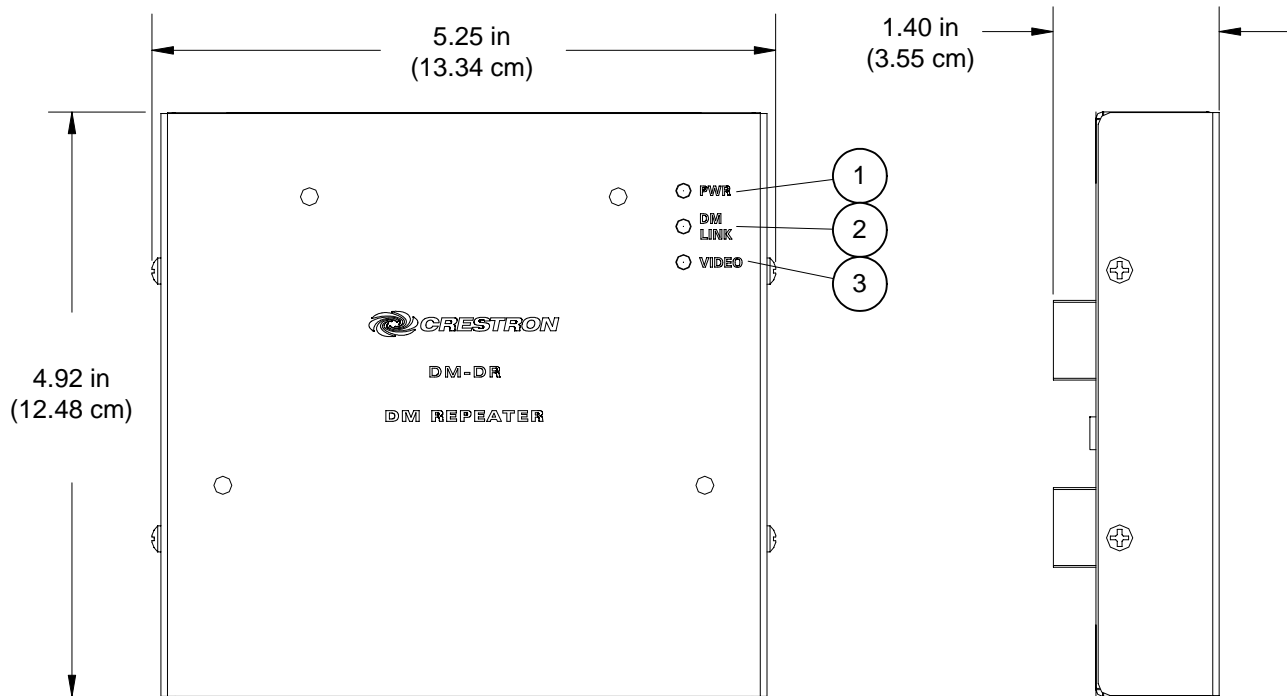

DM-DR Overall Dimensions (Front and Side Views)

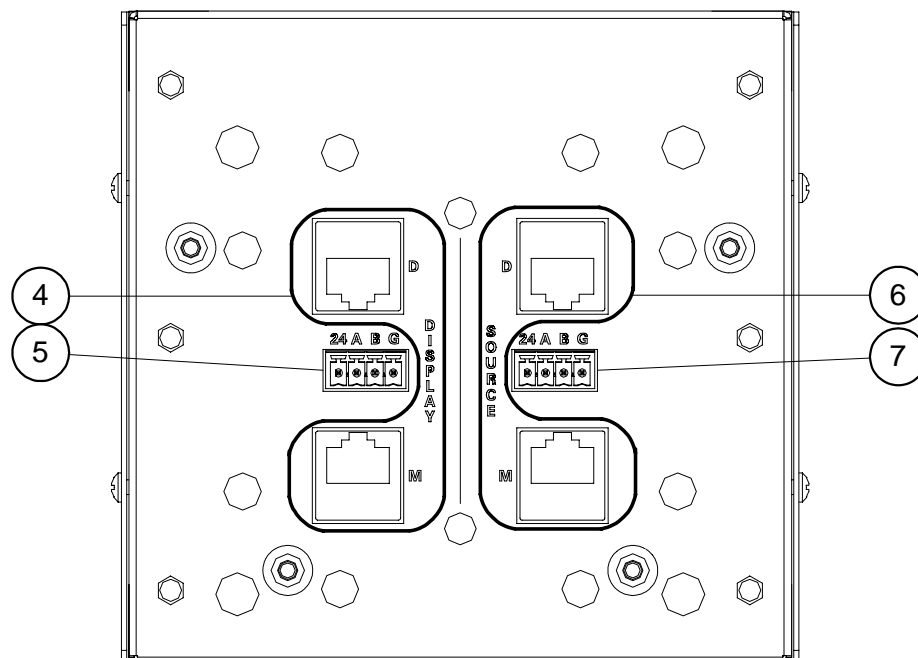

DM-DR Overall Dimensions (Rear View)



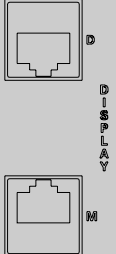

Connectors, Controls & Indicators

#	CONNECTORS ¹ , CONTROLS & INDICATORS	DESCRIPTION
1	PWR LED	Indicates 24 Volts DC power supplied from DMNet control network
2	DM LINK LED	Indicates a valid connection to a DigitalMedia transmitter or receiver
3	VIDEO LED	Indicates status of the video connection: Green: Indicates that the device is receiving video Red: Indicates no video Blinking Red/Green: Indicates errors in the video stream
4	DISPLAY ^{2, 3} 	(1) DM port composed of (2) 8-pin RJ-45 female Connects to DM input of a DM receiver, switcher, or other DM device via DM-CBL or CresCAT-D cable ⁴
5	DISPLAY 24 A B G ^{5, 6} 	(1) 4-pin 3.5mm detachable terminal block, DMNet port. Connects to DMNet port of a DM receiver, switcher, or other DM device via DM-CBL or CresCAT-D cable ⁴

(Continued on following page)

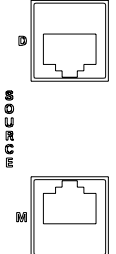
Connectors, Controls & Indicators (Continued)

#	CONNECTORS ¹ , CONTROLS & INDICATORS	DESCRIPTION
6	<p>SOURCE^{2, 3}</p> 	<p>(1) DM port composed of (2) 8-pin RJ-45 female</p> <p>Connects to DM output of a DM switcher, transmitter, or other DM device via DM-CBL or CresCAT-D cable⁴</p>
7	<p>SOURCE 24 A B G^{5, 6}</p> 	<p>(1) 4-pin 3.5mm detachable terminal block, DMNet port.</p> <p>Connects to DMNet port of a DM switcher, transmitter, or other DM device via DM-CBL or CresCAT-D cable⁴</p>

1. Interface connectors for **SOURCE/DISPLAY 24 A B G** ports are provided with the unit.
2. The source and display ports consist of two separate RJ-45 ports that are labeled **D** and **M**. The **D** port carries video signal. The **M** port carries data. Refer to the tables below, and on the following page, for the wires pin assignments.

D Port

PIN #	SIGNAL	DESCRIPTION
1	DATA D0+	HDMI Blue
2	DATA D0-	HDMI Blue
4	DATA D1+	HDMI Green
5	DATA D1-	HDMI Green
7	DATA D2+	HDMI Red
8	DATA D2-	HDMI Red
3	CLK-	HDMI Clock
6	CLK +	HDMI Clock

M Port

PIN #	SIGNAL	DESCRIPTION
1	+5V	+5V Power
2	I2C_DATA	HDCP & EDID Data
3	E_TX-	10/100BaseT Transmit
6	E_TX+	10/100BaseT Transmit
4	E_RX-	10/100BaseT Receive
5	E_RX+	10/100BaseT Receive
7	I2C_CLK	HDCP & EDID Clock
8	+5V_RTN	+5 Power Return

- To determine which is pin 1 on the cable, hold the cable so that the end of the eight pin modular jack is facing away from you, with the clip down and copper side up. Pin 1 is on the far left.
- For DigitalMedia wiring, use DM-CBL DigitalMedia Cable, CresCAT-D, or quality CAT5e/CAT6 cable. Do NOT use low-skew cable. Refer to the latest version of the Crestron DigitalMedia Design Guide (Doc. 4789) for complete wiring guidelines.
- DMNet wiring is not compatible with Cresnet® wiring. DMNet wiring cannot be daisy chained.
- Refer to the table below for the pinout of the **24 A B G** port.

24 A B G Port

PIN #	SIGNAL	Color
24	24V DC	Red
A	DMNet +	Orange
B	DMNet -	Grey
G	Ground	Black

Industry Compliance

This unit has been manufactured to comply with UL's Standards for Safety in Canada and the United States. Formal approval is pending.

As of the date of manufacture, the DM-DR has been tested and found to comply with specifications for CE marking and standards per EMC and Radiocommunications Compliance Labelling.



NOTE: This device complies with part 15 of the FCC rules. Operation is subject to the following two conditions: (1) this device may not cause harmful interference and (2) this device must accept any interference received, including interference that may cause undesired operation.

This equipment has been tested and found to comply with the limits for a Class B digital device, pursuant to part 15 of the FCC Rules. These limits are designed to provide reasonable protection against harmful interference in a residential installation. This equipment generates, uses and can radiate radio frequency energy and if not installed and used in accordance with the instructions, may cause harmful interference to radio communications. However, there is no guarantee that interference will not occur in a particular installation. If this equipment does cause harmful interference to radio or television reception, which can be determined by turning the equipment off and on, the user is encouraged to try to correct the interference by one or more of the following measures:

- Reorient or relocate the receiving antenna.
 - Increase the separation between the equipment and receiver.
 - Connect the equipment into an outlet on a circuit different from that to which the receiver is connected.
 - Consult the dealer or an experienced radio/TV technician for help.
-

Setup

Network Wiring

When wiring the DMNet network, consider the following:

NOTE: DMNet wiring and Cresnet® wiring are not compatible.

- Use Crestron Certified Wire.
- Use Crestron power supplies for Crestron equipment.
- Provide sufficient power to the system.
- For DigitalMedia wiring, use DM-CBL DigitalMedia Cable, CresCAT-D, or quality CAT5e/CAT6 cable. Do NOT use low-skew cable. Refer to the latest version of the Crestron DigitalMedia Design Guide (Doc. 4789) for complete wiring guidelines.

CAUTION: Insufficient power can lead to unpredictable results or damage to the equipment. Please use the DMNet Power Calculator to help calculate how much power is needed for the system (www.crestron.com/calculators).

For more details, refer to “Check Network Wiring” on page 16.

Installation

To prevent overheating, do not operate this product in an area that exceeds the environmental temperature range listed in the table of specifications.

The following is required for installation:

- DigitalMedia cable or CresCAT-D cable (not supplied) terminated with standard RJ-45 connector for media signal (not supplied), RJ-45 shielded field plug (DM-CONN-20) for media signal (not supplied) and mini-phoenix connector for DMNet signals. Refer to “Network Wiring” on page 9.
- Phillips screwdriver (not supplied)
- Four #06-32 x 1/4" pan head Phillips screws (supplied)

- Metal mounting plate (supplied)
- 4-Pin connector plugs (supplied)

It is assumed that DigitalMedia cable (DM-CBL) has been fed through an installed two-gang electrical box, 85mm European or 1900 box electrical box (not supplied) and wiring has been verified. Use the following procedure to install the DM-DR.

NOTE: Cables in the electrical box should be tagged as source and display.

1. Confirm that DMNet system power is OFF.
2. Attach supplied connector plugs according to the pinout on pages 6 and 7.
3. Attach metal mounting plate to electrical box using two Phillips screws (not supplied).
4. Make **SOURCE** connections using DM-CBL.
 - Connect the DMNet cable with the supplied connector plug to the DM-DR's **SOURCE 24 A B G** port.
 - Connect the RJ-45 terminated blue shielded DigitalMedia cable to the **SOURCE D** port.
 - Connect the RJ-45 terminated yellow CAT5e/CAT6 cable to the **SOURCE M** port.
5. Make **DISPLAY** connections using DM-CBL.
 - Connect the DMNet cable with the supplied connector plug to the DM-DR's **DISPLAY 24 A B G** port.
 - Connect the RJ-45 terminated blue shielded DigitalMedia cable to the **DISPLAY D** port.
 - Connect the RJ-45 terminated yellow CAT5e/CAT6 cable to the **DISPLAY M** port.
6. Attach DM-DR to mounting plate using four #06-32 x 1/4" Phillips screws (supplied) as shown in illustration on the following page.

Mounting DM-DR into Electrical Box

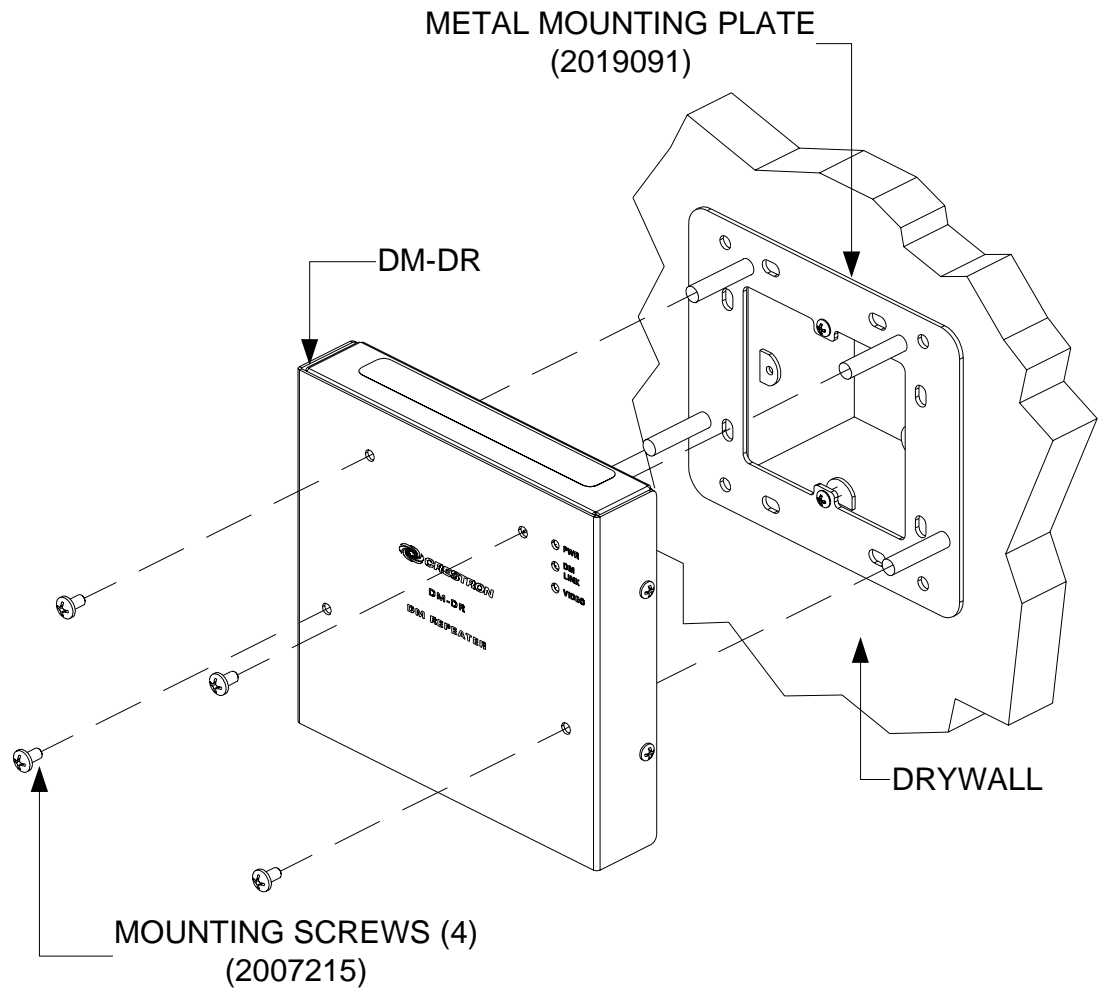

Hardware Hookup

Make the necessary connections as called out in the illustration that follows this paragraph. Refer to “Network Wiring” on page 9 before attaching the 4-position terminal block connector. Apply power after all connections have been made.

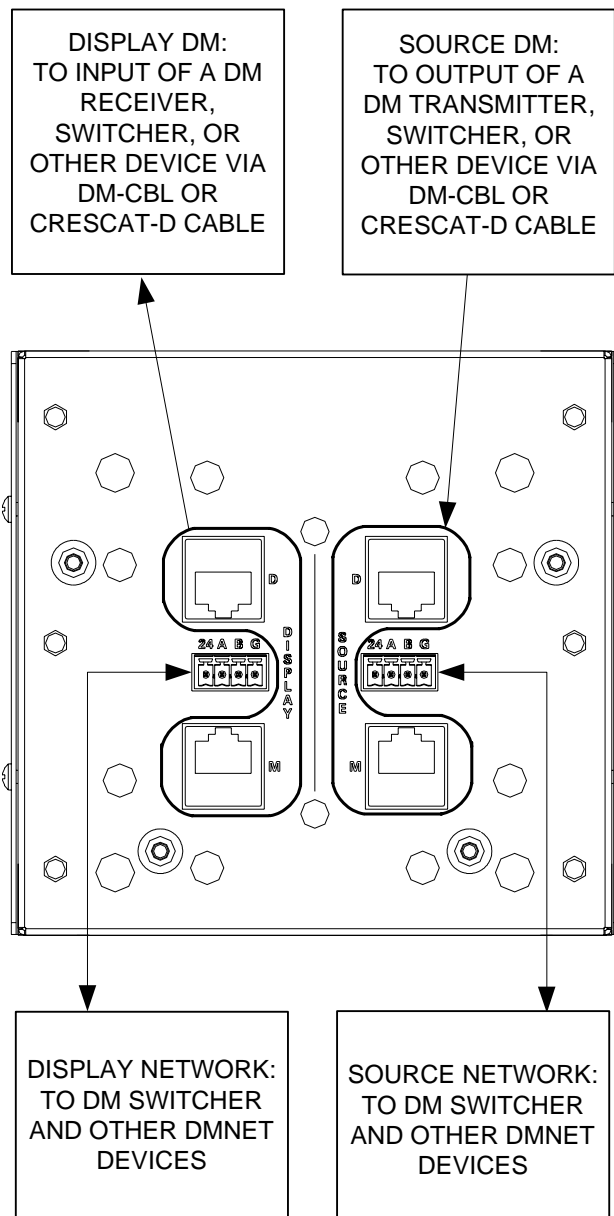
Hardware Connections for the DM-DR

NOTE: Ensure the unit is properly grounded.

NOTE: For optimum performance, Crestron strongly recommends using DM-CBL DigitalMedia cable, available from Crestron. CresCAT-D or high-quality CAT5e/CAT6 wiring may also be used with varying performance. Do NOT use low-skew cable.

Uploading and Upgrading

Crestron recommends using the latest programming software and that each device contains the latest firmware to take advantage of the most recently released features. However, before attempting to upload or upgrade it is necessary to establish communication. Once communication has been established, files (for example, firmware) can be transferred to the device.

Establishing Communication

Use Crestron Toolbox™ for communicating with the DM-DR; refer to the Crestron Toolbox help file for details. There is a single method of communication: indirect communication.

Indirect Communication



- DM-DR connects to a DigitalMedia switcher via DMNet.
- Establish communication between the PC and the DM switcher as described in the latest version of a DigitalMedia Switcher Operations Guide (Doc. 6755).
- Use the Address Book in Crestron Toolbox to create an entry for the DM-DR using the expected communication protocol (Indirect). Select the Cresnet ID of the DM-DR and the address book entry of the control system that is connected to the DM-DR.
- Display the DM-DR's "System Info" window (click the  icon); communications are confirmed when the device information is displayed.

Firmware

Firmware files may be distributed from programmers to installers or from Crestron to dealers. Firmware upgrades are available from the Crestron

website as new features are developed after product releases. For details on upgrading, refer to the Crestron Toolbox help file.

Check the Crestron website to find the latest firmware. (New users may be required to register to obtain access to certain areas of the site, including the FTP site.)

Upgrade DM-DR firmware via Crestron Toolbox.

- Establish communication with the DM-DR and display the “System Info” window.
- Select **Functions | Firmware...** to upgrade the DM-DR firmware.

Program Checks

Using Crestron Toolbox, display the network device tree (**Tools | Network Device Tree**) to show all network devices connected to the control system. Right-click on the DM-DR to display actions that can be performed on the DM-DR.

Problem Solving

Troubleshooting

The following table provides corrective action for possible trouble situations. If further assistance is required, please contact a Crestron customer service representative.

DM-DR Troubleshooting

TROUBLE	POSSIBLE CAUSE(S)	CORRECTIVE ACTION
Device does not function.	Device is not communicating with the network.	Use Crestron Toolbox to poll the network. Verify network connection to the device.
	Device is not receiving power from a Crestron power source.	Use a Crestron power source. Verify connections.
	Device is not receiving sufficient power.	Use the DMNet Power Calculator to help calculate how much power is needed for the system.
Video LED does not illuminate.	Device is not receiving video signal.	Ensure proper video signal is routed to repeater.
Video LED blinks red and green.	Problem with video source.	Verify source is operating.

(Continued on following page)

DM-DR Troubleshooting (Continued)

TROUBLE	POSSIBLE CAUSE(S)	CORRECTIVE ACTION
DM LINK LED does not illuminate.	Device is not sending or receiving DMNet signal.	Verify DMNet is properly attached.
PWR LED does not illuminate.	Device is not receiving power.	Verify DMNet is properly attached.
Loss of functionality due to electrostatic discharge.	Improper grounding.	Check that all ground connections have been made properly.

Check Network Wiring*Use the Right Wire*

In order to ensure optimum performance over the full range of your installation topology, Crestron Certified Wire and only Crestron Certified Wire may be used. Failure to do so may incur additional charges if support is required to identify performance deficiencies because of using improper wire.

Calculate Power

CAUTION: Use only Crestron power supplies for Crestron equipment. Failure to do so could cause equipment damage or void the Crestron warranty.

CAUTION: Provide sufficient power to the system. Insufficient power can lead to unpredictable results or damage to the equipment. The **EIG** connector on the DM switcher is used to jumper in external power. Additional power is rarely required; switchers provide enough power for their maximum configuration of room controllers and repeaters. Please use the DMNet Power Calculator to help calculate how much power is needed for the system (www.crestron.com/calculators).

Refer to the following table for maximum cable lengths for various cables.

Maximum Cable Length by Type

Cable Type:	DM-CBL DigitalMedia Cable		CresCAT-D Crestron Home® CAT5 AV Cable	
	Maximum length between, before, or after repeaters	Maximum total length using up to 3 repeaters	Maximum length between, before, or after repeaters	Maximum total length using up to 3 repeaters
Resolution:				
720p, 1080i, 1080p/24	200 ft (60 m)	450 ft (137 m)	150 ft (45 m)	400 ft (120 m)
1024x768 @75Hz	200 ft (60 m)	450 ft (137 m)	150 ft (45 m)	400 ft (120 m)
1080p/60	150 ft (45 m)	450 ft (137 m)	100 ft (30 m)	400 ft (120 m)
1280x1024 @75Hz	150 ft (45 m)	450 ft (137 m)	100 ft (30 m)	400 ft (120 m)
1920x1200 @60Hz	150 ft (45 m)	450 ft (137 m)	100 ft (30 m)	400 ft (120 m)
1600x1200 @60Hz	125 ft (38 m)	450 ft (137 m)	75 ft (23 m)	400 ft (120 m)
1080p/60 Deep Color	100 ft (30 m)	400 ft (120 m)	Not Supported	

NOTE: All Crestron certified DMNet wiring must consist of two twisted pairs. One twisted pair is the +24V conductor and the GND conductor and the other twisted pair is the A conductor and the B conductor.

Reference Documents

The latest version of all documents mentioned within the guide can be obtained from the Crestron website (www.crestron.com/manuals). This link will provide a list of product manuals arranged in alphabetical order by model number.

List of Related Reference Documents

DOCUMENT TITLE
Crestron DigitalMedia Design Guide
DigitalMedia Switcher Operations Guide

Further Inquiries

If you cannot locate specific information or have questions after reviewing this guide, please take advantage of Crestron's award winning customer service team by calling Crestron at 1-888-CRESTRON [1-888-273-7876].

You can also log onto the online help section of the Crestron website (www.crestron.com/onlinehelp) to ask questions about Crestron products. First-time users will need to establish a user account to fully benefit from all available features.

Future Updates

As Crestron improves functions, adds new features and extends the capabilities of the DM-DR, additional information may be made available as manual updates. These updates are solely electronic and serve as intermediary supplements prior to the release of a complete technical documentation revision.

Check the Crestron website periodically for manual update availability and its relevance. Updates are identified as an “Addendum” in the Download column.

Return and Warranty Policies

Merchandise Returns / Repair Service

1. No merchandise may be returned for credit, exchange or service without prior authorization from CRESTRON. To obtain warranty service for CRESTRON products, contact an authorized CRESTRON dealer. Only authorized CRESTRON dealers may contact the factory and request an RMA (Return Merchandise Authorization) number. Enclose a note specifying the nature of the problem, name and phone number of contact person, RMA number and return address.
2. Products may be returned for credit, exchange or service with a CRESTRON Return Merchandise Authorization (RMA) number. Authorized returns must be shipped freight prepaid to CRESTRON, 6 Volvo Drive, Rockleigh, N.J. or its authorized subsidiaries, with RMA number clearly marked on the outside of all cartons. Shipments arriving freight collect or without an RMA number shall be subject to refusal. CRESTRON reserves the right in its sole and absolute discretion to charge a 15% restocking fee plus shipping costs on any products returned with an RMA.
3. Return freight charges following repair of items under warranty shall be paid by CRESTRON, shipping by standard ground carrier. In the event repairs are found to be non-warranty, return freight costs shall be paid by the purchaser.

CRESTRON Limited Warranty

CRESTRON ELECTRONICS, Inc. warrants its products to be free from manufacturing defects in materials and workmanship under normal use for a period of three (3) years from the date of purchase from CRESTRON, with the following exceptions: disk drives and any other moving or rotating mechanical parts, pan/tilt heads and power supplies are covered for a period of one (1) year; touchscreen display and overlay components are covered for 90 days; batteries and incandescent lamps are not covered.

This warranty extends to products purchased directly from CRESTRON or an authorized CRESTRON dealer. Purchasers should inquire of the dealer regarding the nature and extent of the dealer's warranty, if any.

CRESTRON shall not be liable to honor the terms of this warranty if the product has been used in any application other than that for which it was intended or if it has been subjected to misuse, accidental damage, modification or improper installation procedures. Furthermore, this warranty does not cover any product that has had the serial number altered, defaced or removed.

This warranty shall be the sole and exclusive remedy to the original purchaser. In no event shall CRESTRON be liable for incidental or consequential damages of any kind (property or economic damages inclusive) arising from the sale or use of this equipment. CRESTRON is not liable for any claim made by a third party or made by the purchaser for a third party.

CRESTRON shall, at its option, repair or replace any product found defective, without charge for parts or labor. Repaired or replaced equipment and parts supplied under this warranty shall be covered only by the unexpired portion of the warranty.

Except as expressly set forth in this warranty, CRESTRON makes no other warranties, expressed or implied, nor authorizes any other party to offer any warranty, including any implied warranties of merchantability or fitness for a particular purpose. Any implied warranties that may be imposed by law are limited to the terms of this limited warranty. This warranty statement supersedes all previous warranties.

Trademark Information

All brand names, product names and trademarks are the sole property of their respective owners. Windows is a registered trademark of Microsoft Corporation. Windows95/98/Me/XP/Vista and WindowsNT/2000 are trademarks of Microsoft Corporation.



Crestron Electronics, Inc.
15 Volvo Drive Rockleigh, NJ 07647
Tel: 888.CRESTRON
Fax: 201.767.7576
www.crestron.com

**Operations & Installation Guide – DOC. 6745A
(2022554)**

12.08

Specifications subject to
change without notice.